



UiO : Universitetet i Oslo



UNIK4230: Mobile Communications Spring 2015

Per Hjalmar Lehne

per-hjalmar.lehne@telenor.com

Tel: 916 94 909

Cells and Cellular Traffic (Chapter 4)

Date: 12 March 2015

Agenda

- Introduction
- Hexagonal Cell Geometry
- Co-Channel Interference (CCI)
- CCI Reduction techniques
- Cell Splitting
- Hierarchical Cell Structure
- Coverage Area Estimation
- Traffic Capacity and Trunking
- Adjacent Channel Interference
- Summary

Cells and Cellular Traffic

- Introduction
- Hexagonal Cell Geometry
- Co-Channel Interference (CCI)
- CCI Reduction techniques
- Cell Splitting
- Hierarchical Cell Structure
- Coverage Area Estimation
- Traffic Capacity and Trunking
- Adjacent Channel Interference
- Summary

Cell and Frequency Reuse

- **Cell:** Limited geographic area covered by a base station in a mobile system
- **Frequency reuse:** The same channel (frequency) is used in several cells apart

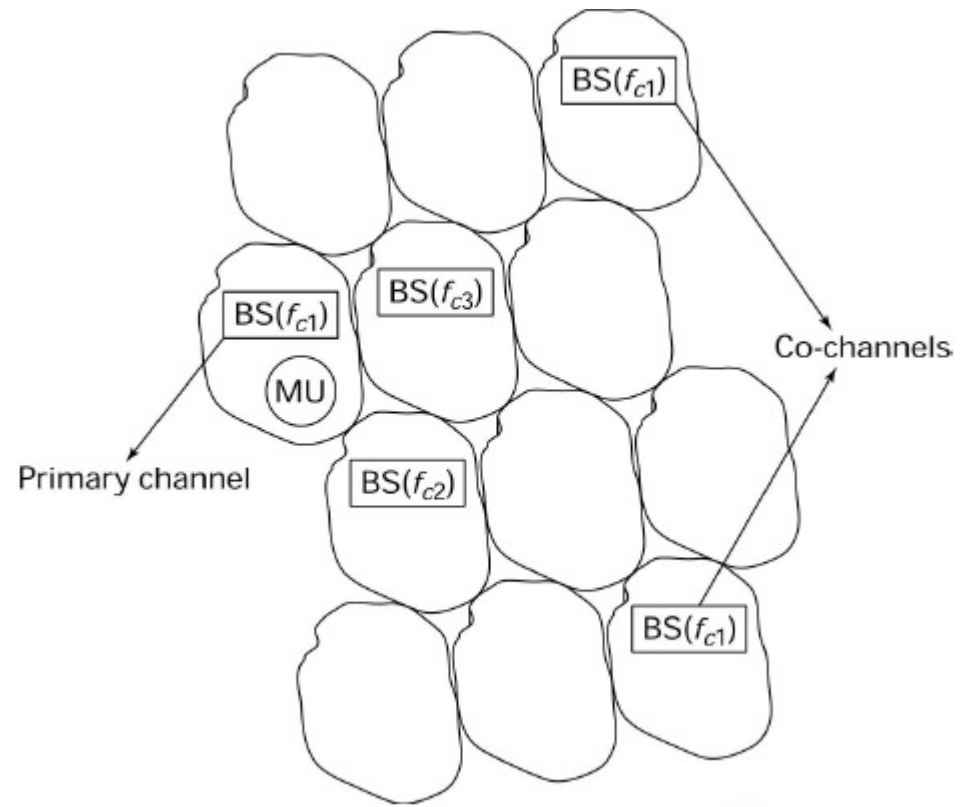

Why frequency reuse?

- **Why reuse the frequency?**
- 8 MHz = 40 channels * 8 timeslots = 320 users
==> max. 320 simultaneous calls!!!
- **Limited bandwidth**
- **Interference is unavoidable**
 - Minimize total interference in network

Co-channel Interference (CCI)

- CCI: Interference from other cells using the same channel (frequency)

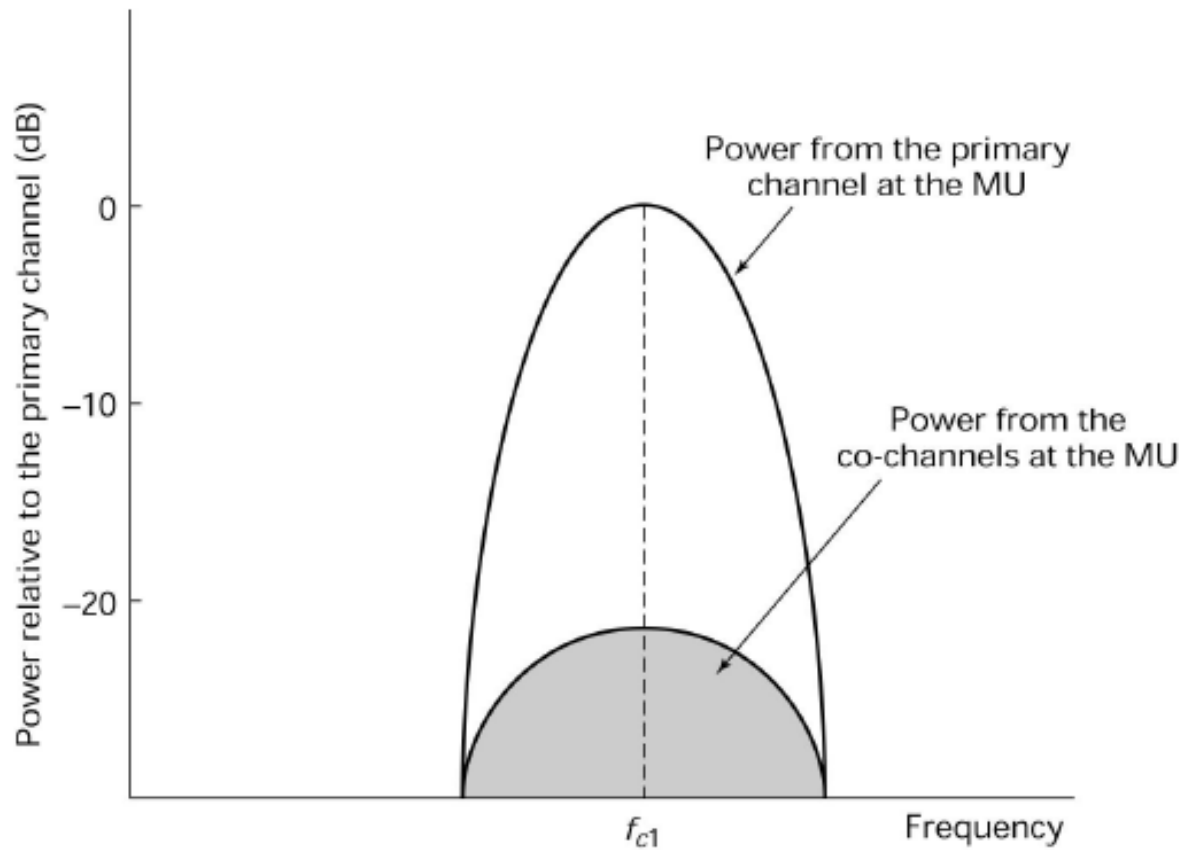

Cells and Cellular Traffic

- Introduction
- **Hexagonal Cell Geometry**
- Co-Channel Interference (CCI)
- CCI Reduction techniques
- Cell Splitting
- Hierarchical Cell Structure
- Coverage Area Estimation
- Traffic Capacity and Trunking
- Adjacent Channel Interference
- Summary

Cell geometry

- Different cell types are present in the planning of a mobile network
- Hexagonal cells describes complete coverage, and provides an approximate picture of the symmetry experienced by normal radio propagation

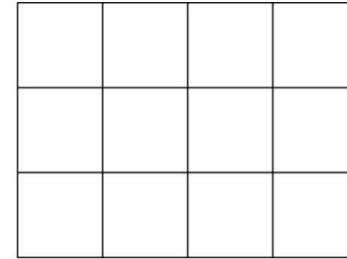

(a)

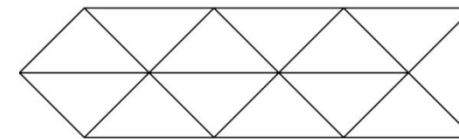

(b)

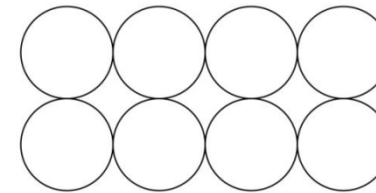

(c)

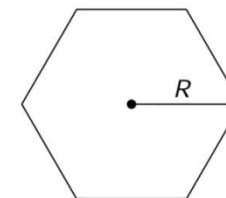

(d)

Cell geometry

- Using hexagonal cells, overlap is minimized when circular cells are deployed along a hexagonal grid as shown in c)
- The hexagonal layout is the most economically efficient one, as it requires the fewest cells to cover a given area

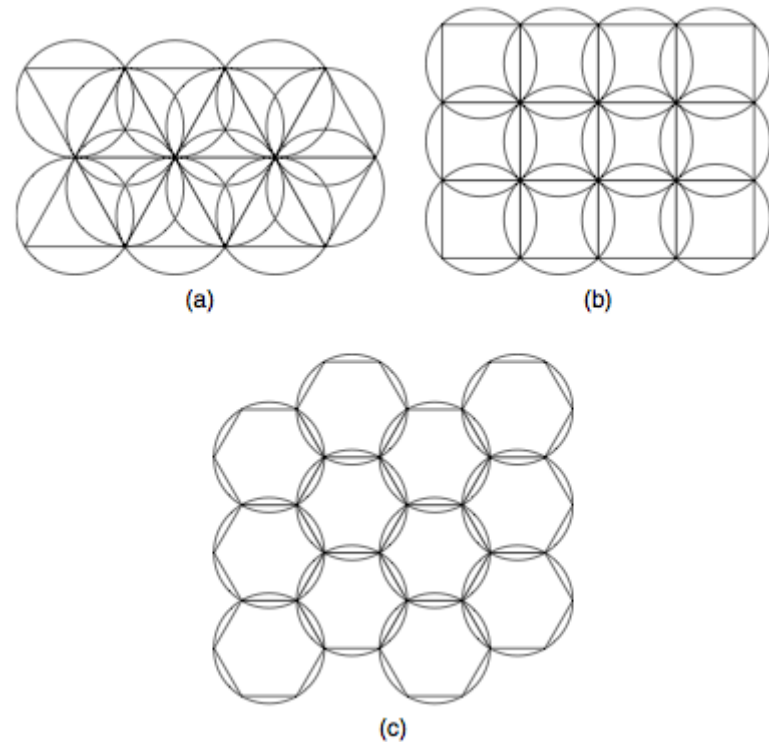

Hexagonal cell geometry

- A new hexagonal coordinate system (u, v) is considered such that the positive coordinate axes intersect at a 60 degree angle and the unit distance along either axis is equal to $\sqrt{3}R$
- The center to center distance between any two cells can be written as:

$$D = \{(u_2 - u_1)^2 \cos^2(\pi/6) + [(v_2 - v_1) + (u_2 - u_1)\sin(\pi/6)]^2\}^{1/2}$$

- Simplified form:

$$D = \sqrt{(u_2 - u_1)^2 + (v_2 - v_1)^2 + (u_2 - u_1)(v_2 - v_1)}$$

- Since actual distance is a scale factor of $\sqrt{3}R$,

$$D = \sqrt{i^2 + j^2 + ij}\sqrt{3}R$$

- where (i, j) represents center of a cell in (u, v) coordinates.

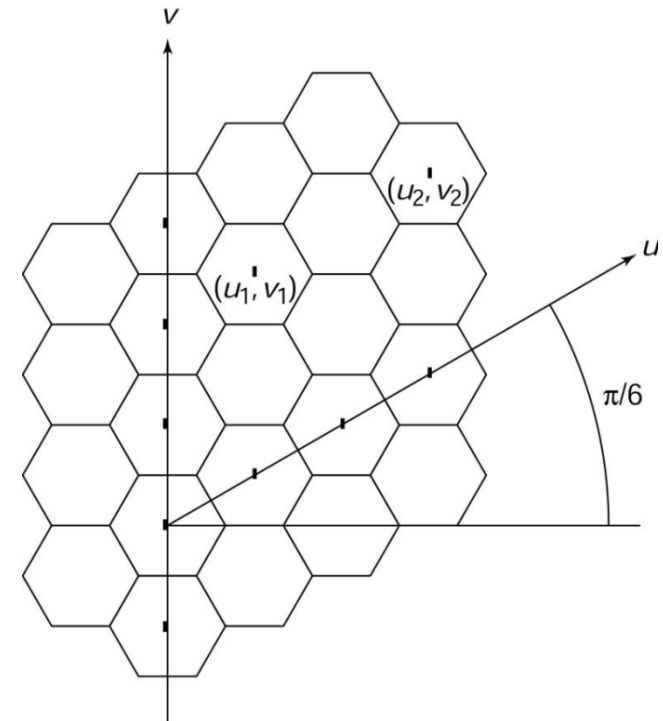

Hexagonal cell geometry

- Alternate derivation of equation

$$D = \sqrt{(u_2 - u_1)^2 + (v_2 - v_1)^2 + (u_2 - u_1)(v_2 - v_1)}$$
$$D = \sqrt{i^2 + j^2 + ij\sqrt{3}R}$$

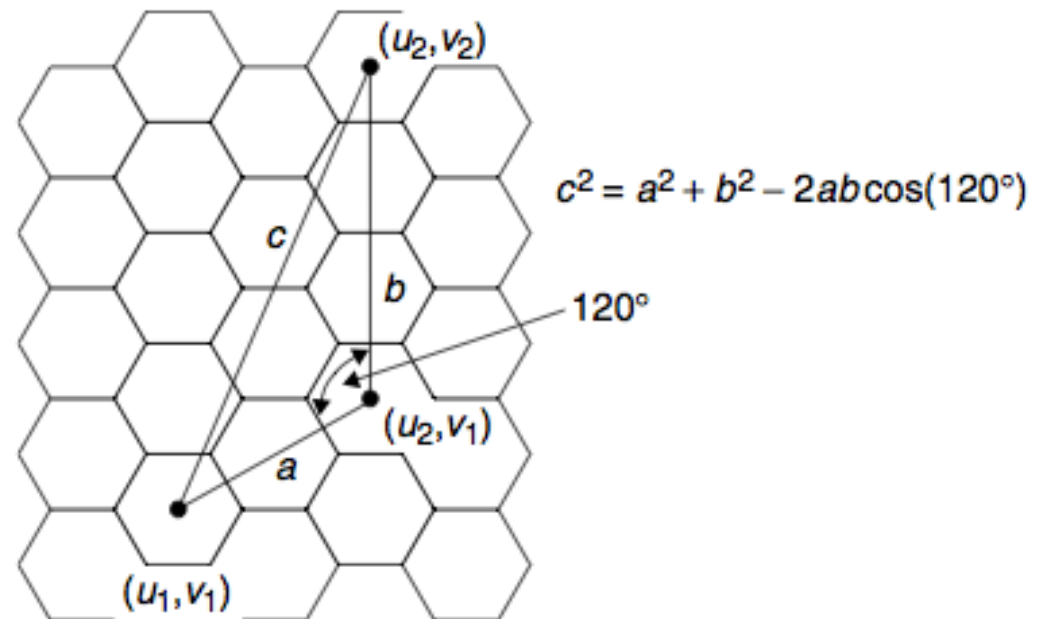

Hexagonal cell geometry

- A Cell Cluster (N_c) is a group of cells where each one uses different channel or frequency
- The normalized separation between any two cells depends only on the cell number counted from the cell at the origin or from a reference cell:

$$N_c = D_R^2$$

- where

$$D_R = \sqrt{i^2 + j^2 + ij}$$

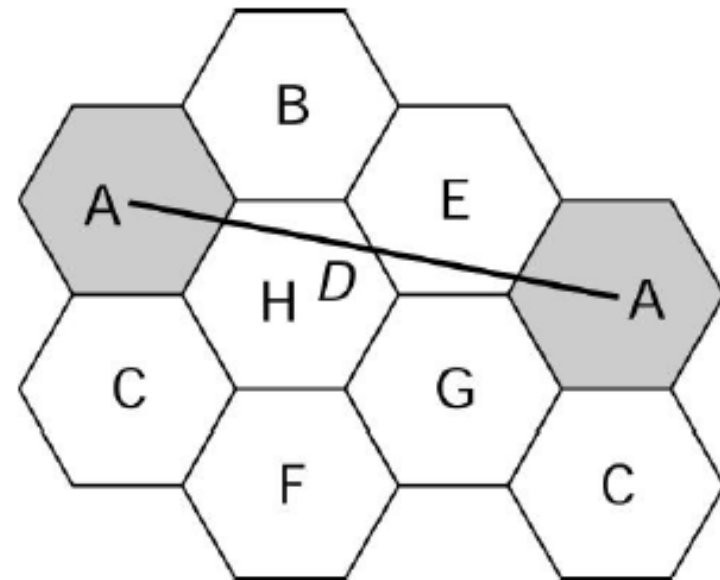

Hexagonal cell geometry

In hexagonal geometry, there are six neighbors of each cell and the line joining the centers of any cell and each of its neighbors are separated by 60 degrees. This restricts the number of usable cluster sizes and their layouts. In order to *tessellate*-to connect cells without gap-the number of cells per cluster, N , can only have values, which satisfy the following equation:

$$N = i^2 + ij + j^2$$

where i and j are non-negative integers. To find the nearest co-channel neighbors of a particular cell, one must do the following:

1. Move i cells along any chain of hexagons.
2. Turn 60 degrees counter-clockwise and move j cells. Figure 5 illustrates this process with $i = 3$, $j = 2$, and $N = 19$.

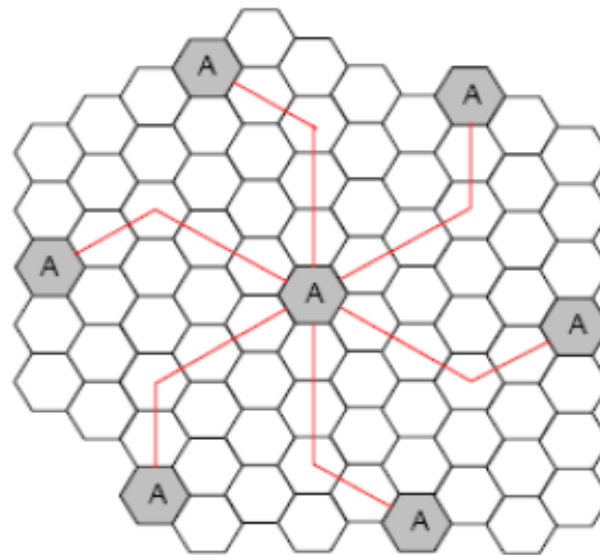

Hexagonal cell geometry

| i | j | N_c | $q=D/R$ |
|-----|-----|-------|---------|
| 1 | 0 | 1 | 1.73 |
| 1 | 1 | 3 | 3 |
| 2 | 0 | 4 | 3.46 |
| 2 | 1 | 7 | 4.58 |
| 3 | 0 | 9 | 5.2 |
| 2 | 2 | 12 | 6 |

- Table shows the relationship between $[i,j]$ and number of cells in a cluster (N_c)
- $q = D/R [\text{sqrt}(3N_c)]$ is also called *frequency reuse factor* or CCI reduction factor
- High q means a low CCI

Example

Example

Let a total of 33MHz of bandwidth be allocated to a particular FDD cellular telephone system, which uses two 25kHz simplex channels to provide full duplex voice and control channels. Compute the number of channels available per cell if the system uses (a) 4-cell reuse, (b) 7-cell reuse, and (c) 12-cell reuse. If 1 MHz of the allocated spectrum is dedicated to control channels, determine an equitable distribution of control channels and voice channels in each cell for each of the three systems.

Answer:

Given: Total bandwidth = 33 MHz.

Channel bandwidth = 25 kHz simplex channels. $25 \times 2 = 50$ kHz duplex channels.

Total available channels = $33,000/50 = 660$ channels.

(a) for $N = 4$, total number of channels available per cell = $660/4 \approx 165$ channels.

(b) for $N = 7$, total number of channels available per cell = $660/7 \approx 95$ channels.

(c) for $N = 12$, total number of channels available per cell = $660/12 \approx 55$ channels.

Example

A 1 MHz spectrum for control channels implies that there are $1000/50 = 20$ control channels out of the 660 channels available. To evenly distribute the control and voice channels, simply allocate the same number of channels in each cell wherever possible. Here, the 660 channels must be evenly distributed to each cell within the cluster. In practice, only the 640 voice channels would be allocated, since the control channels are allocated separately as 1 per cell.

(a) For $N = 4$, we can have 5 control channels and 160 voice channels per cell. In practice, however, each cell only needs a single control channel (the control channels have a greater reuse distance than the voice channels). Thus, one control channel and 160 voice channels would be assigned to each cell.

(b) For $N = 7$, 4 cells with 3 control channels and 92 voice channels, 2 cells with 3 control channels and 90 voice channels, and 1 cell with 2 control channels and 92 voice channels could be allocated. In practice, however, each cell would have one control channel, four cells would have 91 voice channels, and three cells would have 92 voice channels.

(c) For $N = 12$, we can have 8 cells with 2 control channels and 53 voice channels, and four cells with 1 control channel and 54 voice channels each. In an actual system, each cell would have 1 control channel, 8 cells would have 53 voice channels, and 4 cells would have 54 voice channels.

Cells and Cellular Traffic

- Introduction
- Hexagonal Cell Geometry
- **Co-Channel Interference (CCI)**
- CCI Reduction techniques
- Cell Splitting
- Hierarchical Cell Structure
- Coverage Area Estimation
- Traffic Capacity and Trunking
- Adjacent Channel Interference
- Summary

Co-channel Interference (CCI)

- CCI: Interference from other cells used the same channel (frequency)

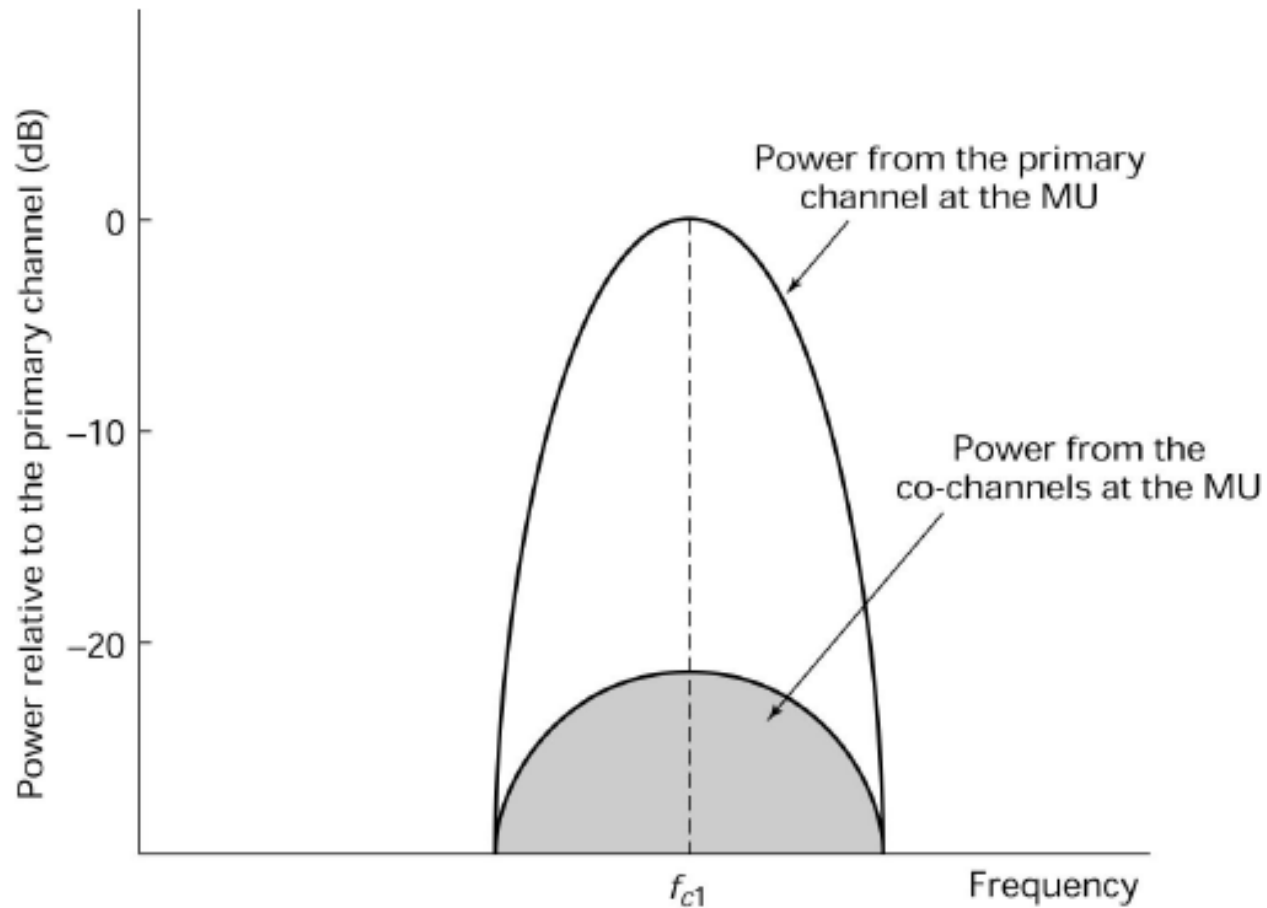

Co-channel Interference (CCI)

- Signal-to-noise ratio can be defined:

$$\frac{S}{N} = \frac{\text{Signal power (S)}}{\text{noise power (N}_S) + \text{interfering signal power (I)}}$$

- Signal-to-CCI ratio can be defined:

$$\frac{S}{I} = \frac{\text{signal power (S)}}{\text{interfering signal power (I)}}$$

- When CCI dominates compared to noise:

$$\frac{S}{N} = \frac{S}{I}$$

Co-channel Interference (CCI)

- Signal to CCI ratio can be expressed generally for a number of interfering cells as:

$$\frac{S}{I} = \frac{R^{-\nu}}{\sum_{k=1}^{N_i} D_k^{-\nu}} = \frac{R^{-\nu}}{N_i D^{-\nu}}$$

- For 6 interfering cells (7 cell cluster):

$$\frac{S}{I} = \frac{1}{6} \left(\frac{D}{R} \right)^{\nu} = \frac{1}{6} (3N_c)^{\nu/2}$$

- For example with $\nu=4$, $N_c=7$:

$$S/I = 73.1 = 18.6 \text{ dB}$$

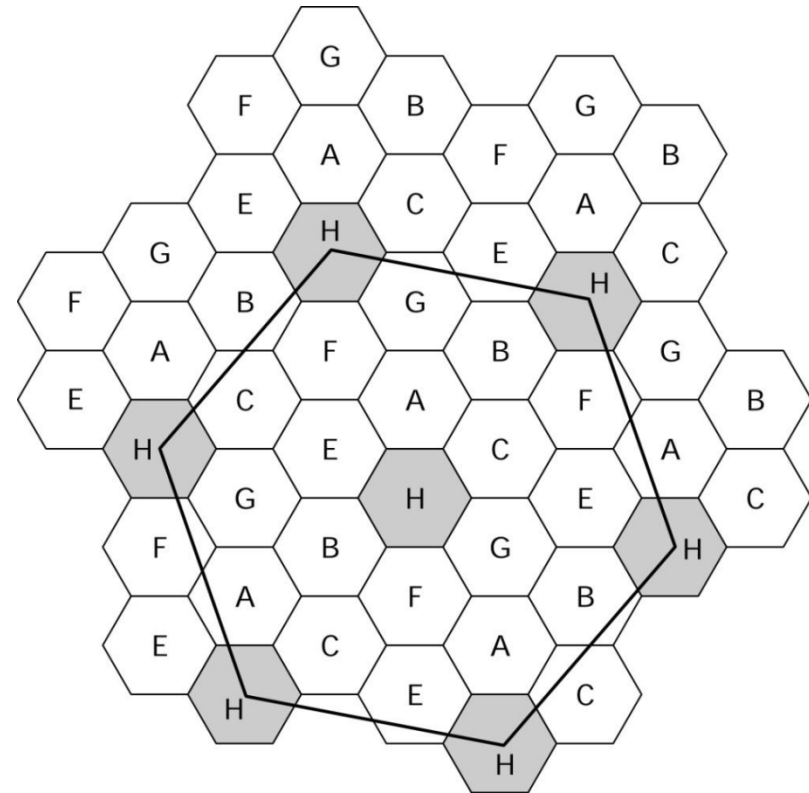

Co-channel Interference (CCI)

- The number of interfering cells is always 6, regardless of the size of the cell group. (The figure shows an example for $N_c = 3$)
- The distance and thus the interference is determined by group size
- $q = D/R$ is called frequency reuse factor or CCI interference reduction factor

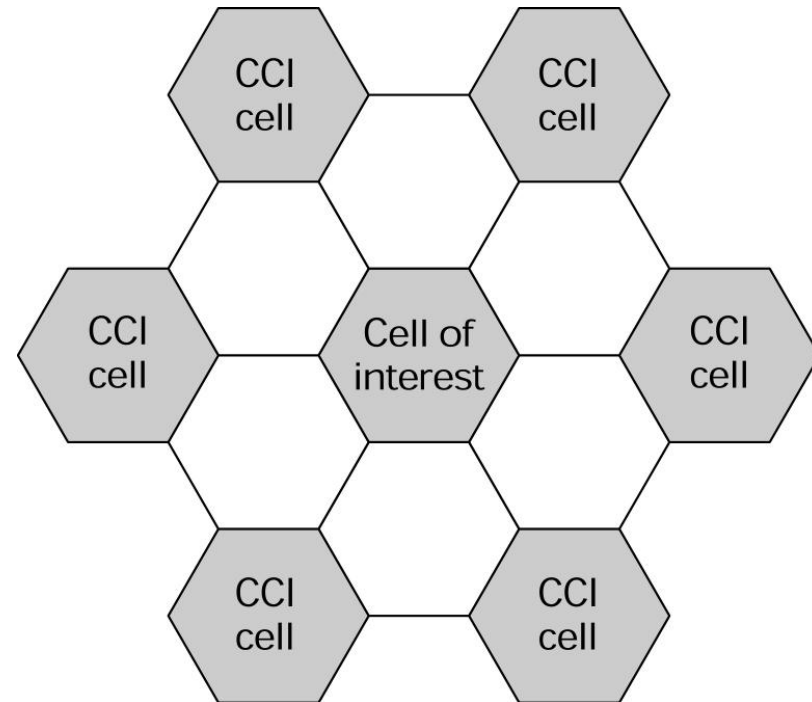

Special Cases of Co-Channel Interference

- When the user is on the cell edge you get:

$$\frac{S}{I} = \frac{R^{-\nu}}{2(D - R)^{-\nu} + 2D^{-\nu} + 2(D + R)^{-\nu}}$$

- Or if $(D-R)$ is used for all distances:

$$\frac{S}{I} = \frac{R^{-\nu}}{6(D - R)^{-\nu}} = \frac{1}{6(q - 1)^{-\nu}}$$

- Greater reuse distance reduces interference, but also reduces the capacity!

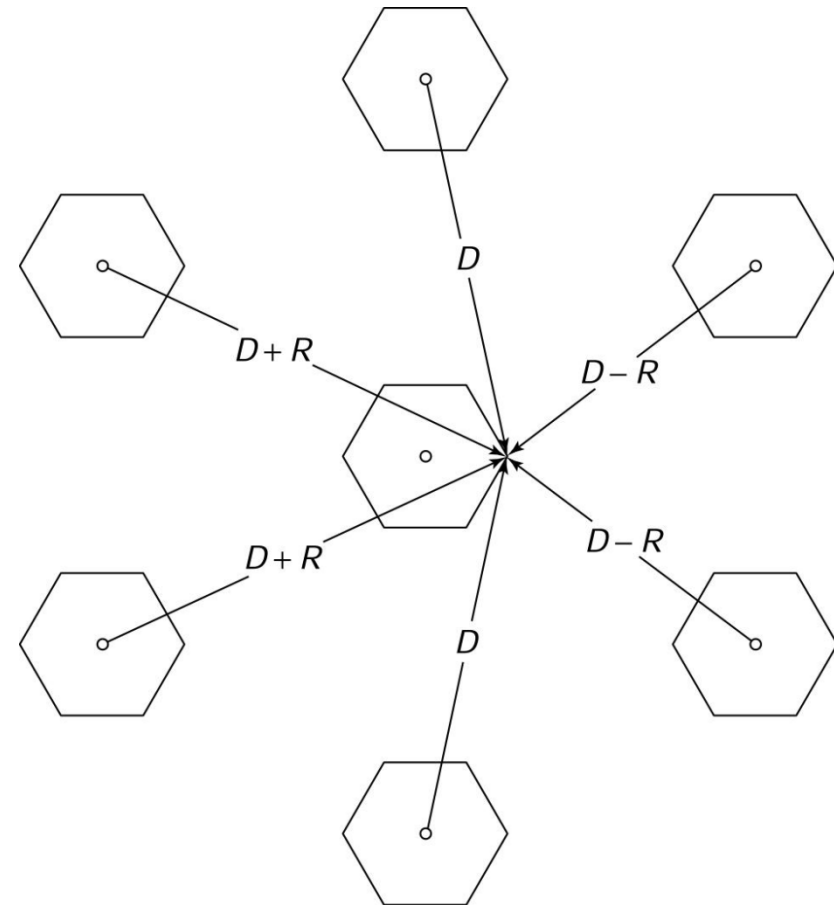

Cells and Cellular Traffic

- Introduction
- Hexagonal Cell Geometry
- Co-Channel Interference (CCI)
- **CCI Reduction techniques**
- Cell Splitting
- Hierarchical Cell Structure
- Coverage Area Estimation
- Traffic Capacity and Trunking
- Adjacent Channel Interference
- Summary

CCI Reduction

- CCI reduction by using sector antennas
- Interference is reduced when directional antennas are used to divide a cell into sectors

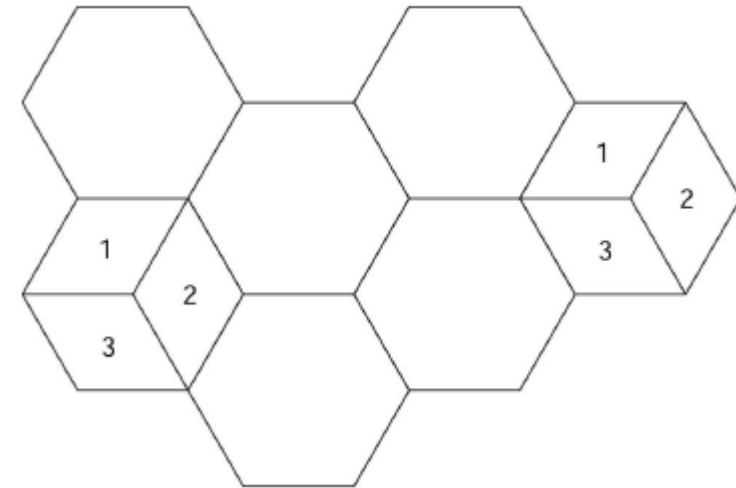
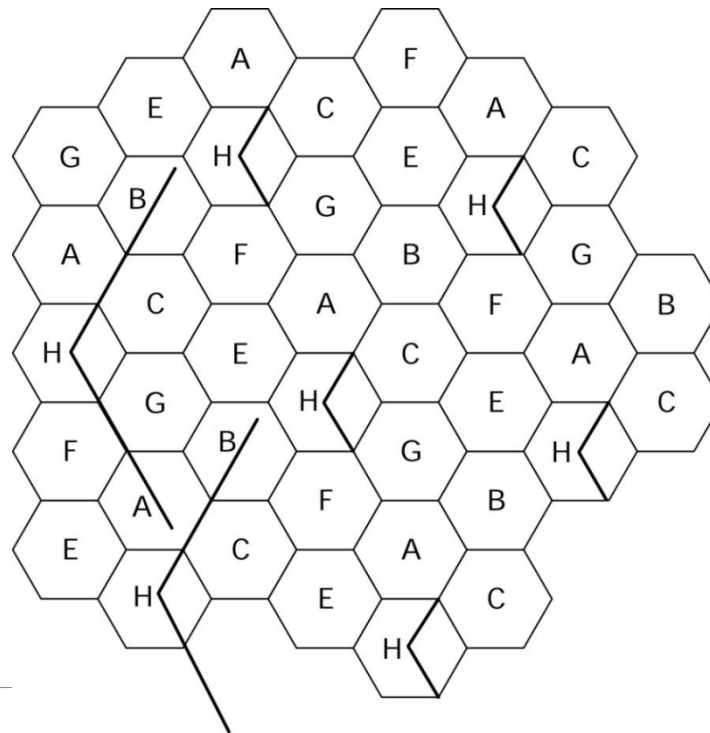

CCI Reduction

- For the 120°-sectors, the CCI is reduced by a factor of 3, which gives:

$$\left[\frac{S}{I}\right]_{120^\circ} = \left[\frac{S}{I}\right]_{omni} + 10\log 3 = \left[\frac{S}{I}\right]_{omni} + 4.77 \text{ dB}$$

- For the 60°-sectors, the CCI is reduced by a factor of 6, which gives:

$$\left[\frac{S}{I}\right]_{60^\circ} = \left[\frac{S}{I}\right]_{omni} + 10\log 6 = \left[\frac{S}{I}\right]_{omni} + 7.78 \text{ dB}$$

CCI Reduction with 60 degree sector

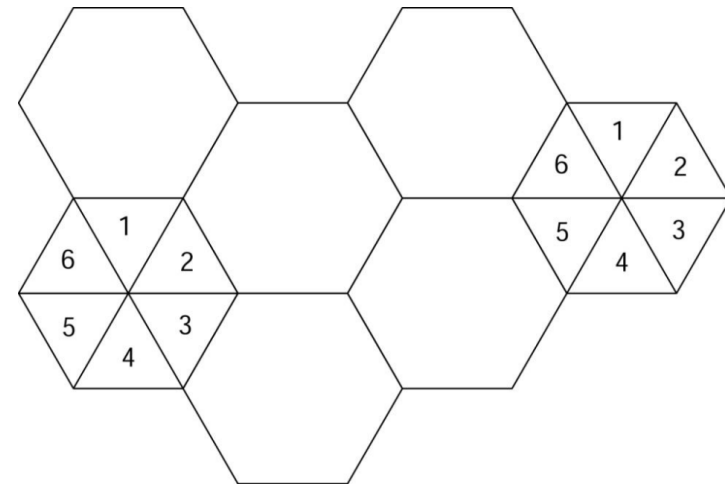
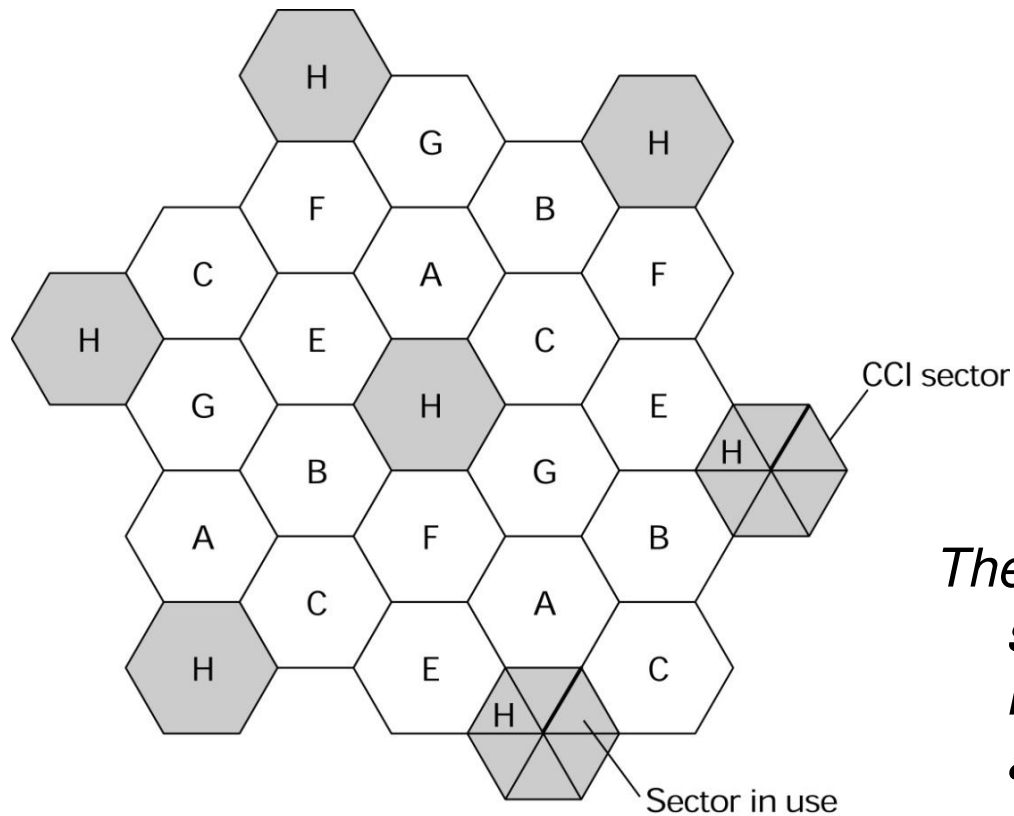

There is a major drawback in the sectorized antenna approach to improve the S/I ratio- it adversely affects the overall capacity of the system.

This can be explained using the concept of trunking.

Several tiers of Interference

- So far a single tier of channel interference is considered at a distance D
- Signal to CCI ratio for 3 tiers:

$$\frac{S}{I} = \frac{R^{-\nu}}{6D^{-\nu} + 6(2D)^{-\nu} + 6(3D)^{-\nu}}$$

- In most cases, the interference from the 2nd and 3rd tiers are negligible.

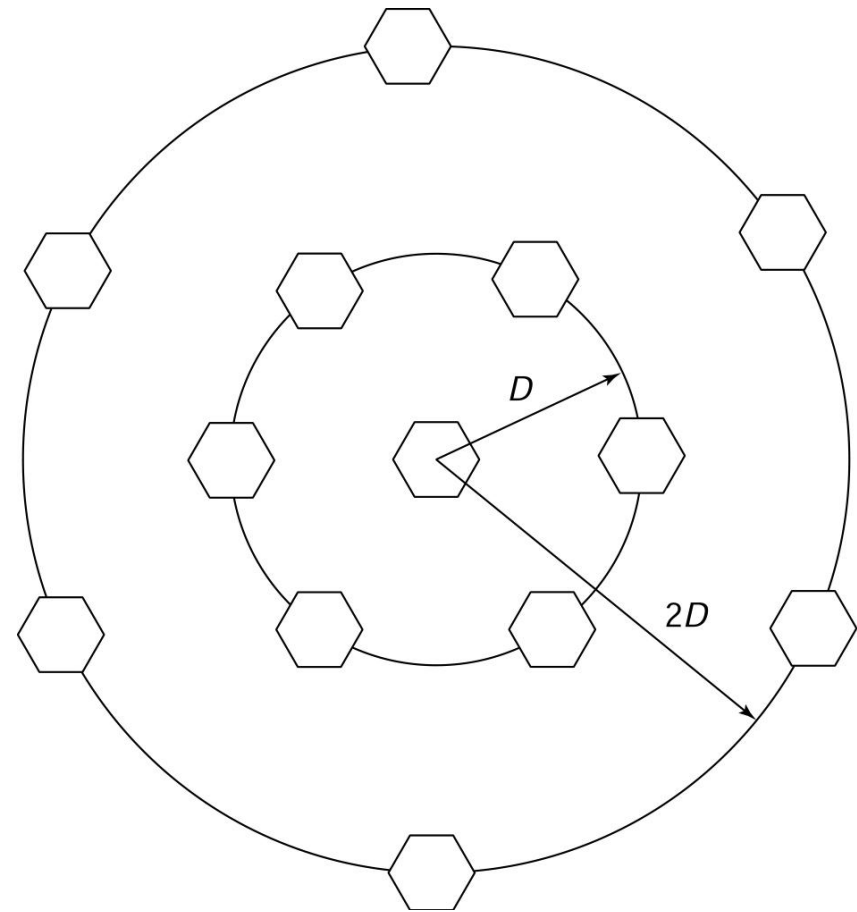

Cells and Cellular Traffic

- Introduction
- Hexagonal Cell Geometry
- Co-Channel Interference (CCI)
- CCI Reduction techniques
- **Cell Splitting**
- Hierarchical Cell Structure
- Coverage Area Estimation
- Traffic Capacity and Trunking
- Adjacent Channel Interference
- Summary

Cell Splitting

- Cell splitting is a technique to divide a cell (congested) into smaller cells to increase capacity
- Cell splitting allows channels to be reused
- Cell splitting also requires adjustment to the antenna transmission power

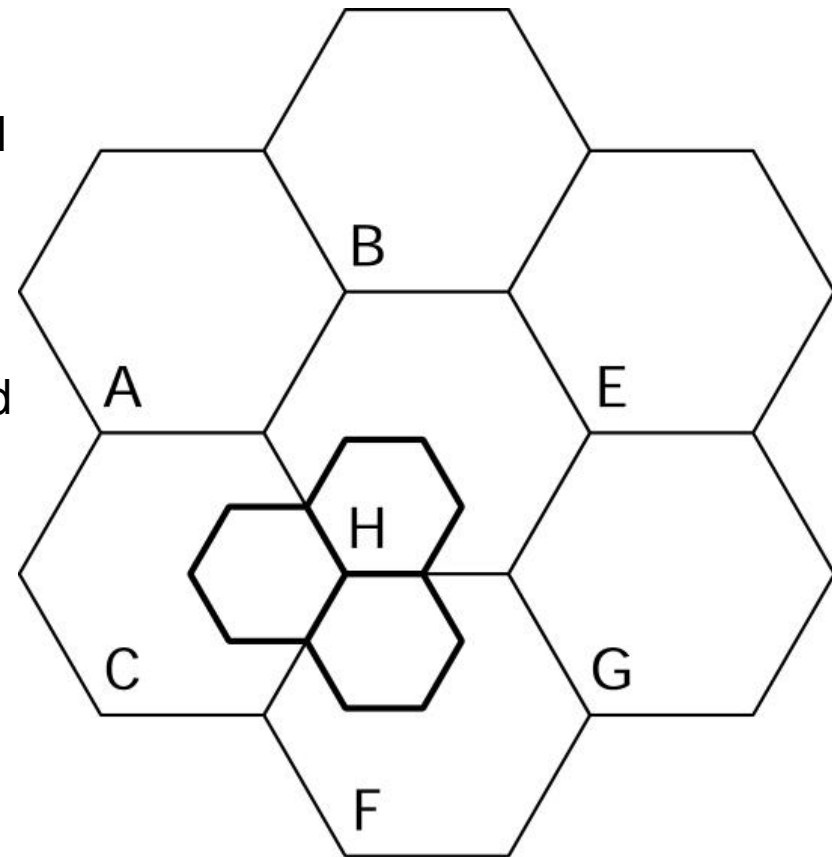

Cells and Cellular Traffic

- Introduction
- Hexagonal Cell Geometry
- Co-Channel Interference (CCI)
- CCI Reduction techniques
- Cell Splitting
- **Hierarchical Cell Structure**
- Coverage Area Estimation
- Traffic Capacity and Trunking
- Adjacent Channel Interference
- Summary

Hierarchical cell structure

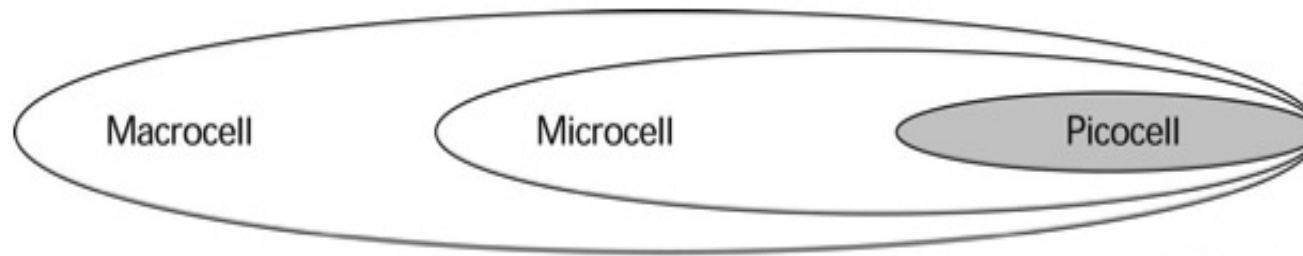

- Complexity of operation increases
 - Number of hand-over goes up
 - Increasing signaling load
 - Increasing switching & control load
- Solution: Fiber Optic Mobile (FOM) System

Fiber Optic Mobile (FOM) System

- Several BTS linked using optical fibers and controlled from the same location
- BTSs only receives/transmits
- Switching & channel allocation centrally

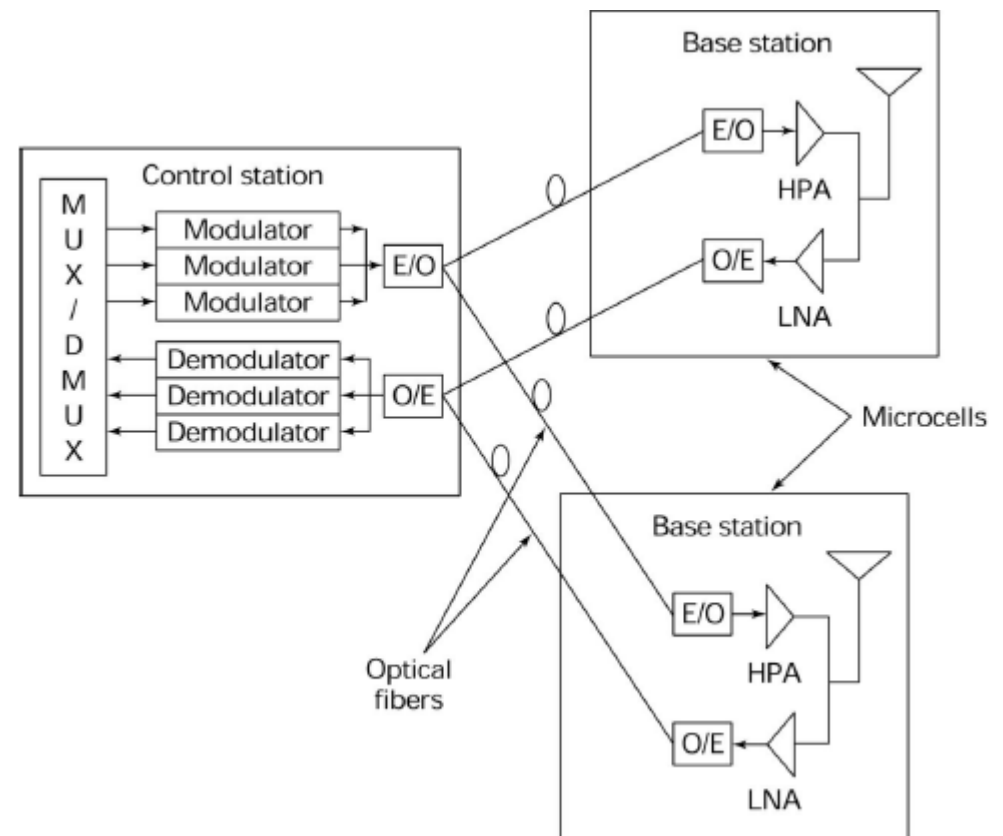

Macro Cell Network

- Cost performance solution
- Suitable for covering large area
 - Large cell range
 - High antenna position
- Cell ranges 2 ..20km
- Used with low traffic volume
 - Typically rural area
 - Road coverage
- Normally Use omnidirectional antenna
 - Exception: Use beamed antenna for road coverage

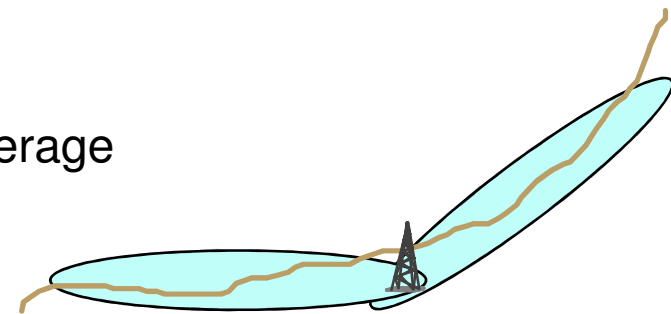
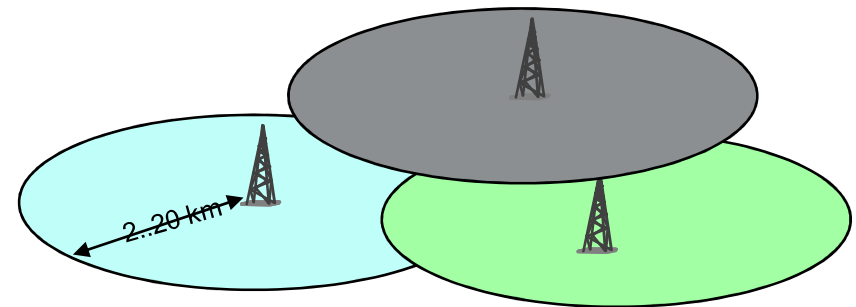

Micro Cell Network

- Capacity oriented network
- Suitable for high traffic area
- Mostly used with beamed cell
 - Cost performance solution
 - Usage of available site's equipment
- Typical application
 - Medium town
 - Suburb
- Typical coverage range: 0.5 .. 2km

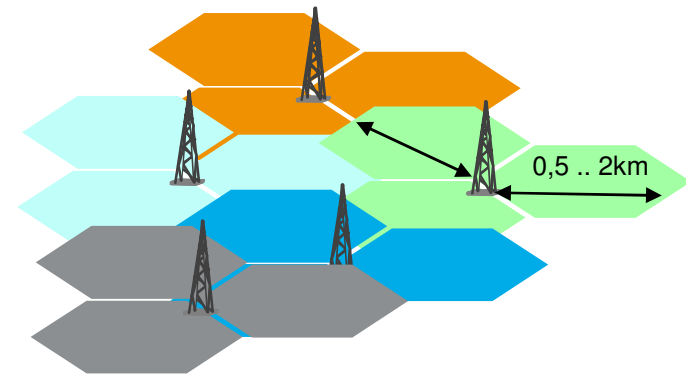

Cells and Cellular Traffic

- Introduction
- Hexagonal Cell Geometry
- Co-Channel Interference (CCI)
- CCI Reduction techniques
- Cell Splitting
- Hierarchical Cell Structure
- **Coverage Area Estimation**
- Traffic Capacity and Trunking
- Adjacent Channel Interference
- Summary

Cell Coverage Area Estimation

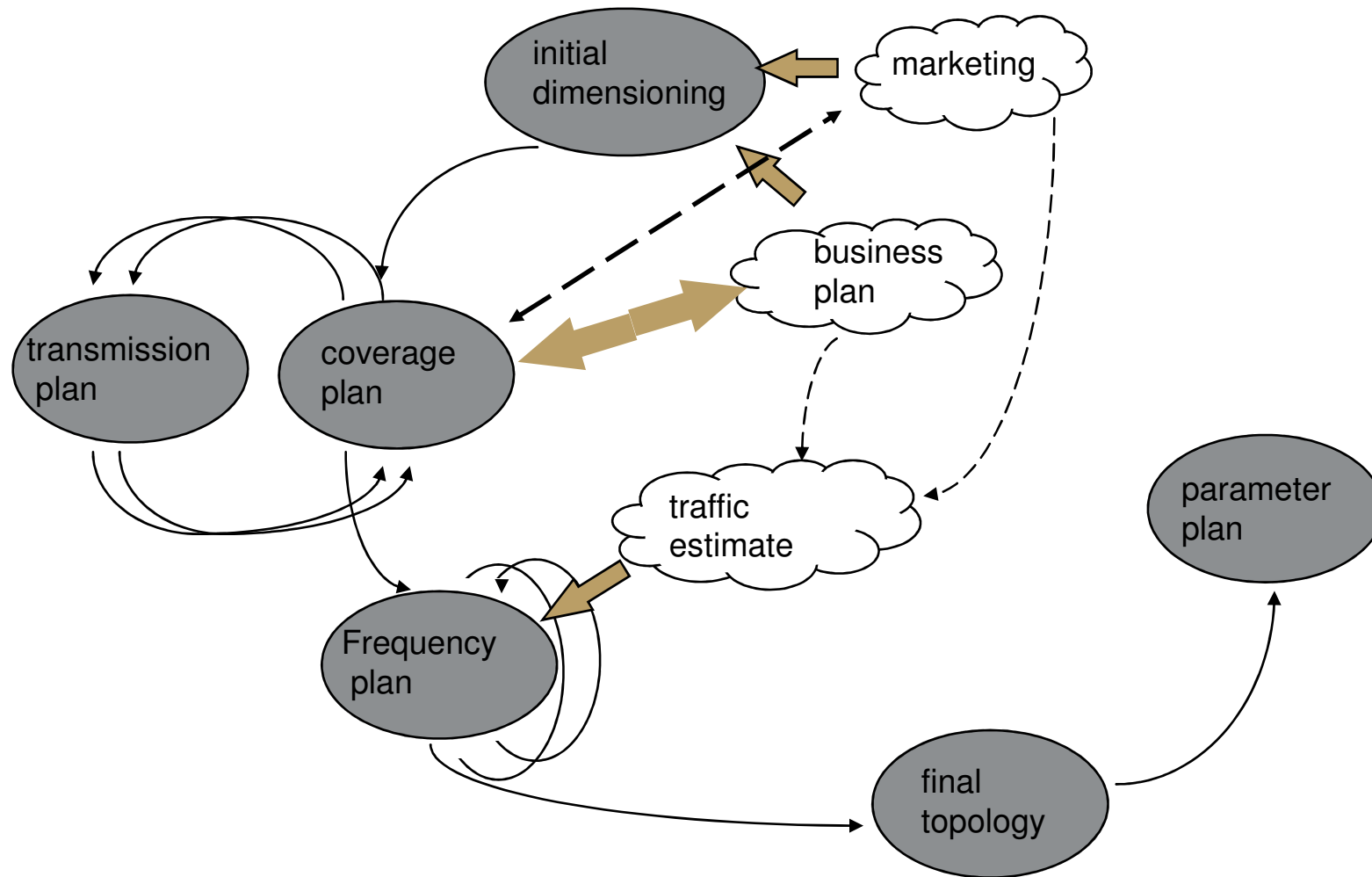

Cell Coverage Area Estimation

- Transmitter power, P_T (dBm)
- Sensitivity of the receiver or threshold power, P_{th} (dBm)
 - Receiver sensitivity indicates the weakest RF signal, which can be successfully received by the receiver. The lower the power level that the receiver can successfully process, the better the receiver sensitivity.

- Power loss from transmission, L_p (dB)

$$L_p = P_T - P_{th}$$

- As the signal undergoes long-term fading, a fade margin M should be included
 - The amount by which a received signal level may be reduced without causing system performance to fall below a specified threshold value

$$L_p = P_T - P_{th} - M$$

- The fade margin reduces the permitted loss and reduces the transmission distance

Computation of Fading Margin

- The probability density function of received power under long term fading:

$$f(p_{LT}) = \frac{1}{\sqrt{2\pi\sigma^2 p_{LT}^2}} \exp \left[-\frac{1}{2\sigma^2} \ln^2 \left(\frac{p_{LT}}{p_0} \right) \right]$$

- Where p_{LT} is the power in mW, p_0 is the median power and σ is standard deviation of the fading.
- The outage probability at the boundary of the cell is given by:

$$P_{out}(R) = \int_0^{P_{th}} f(p_{LT}) dp_{lt} = \frac{1}{2} \operatorname{erfc} \left[\frac{\ln(P_0(R)/P_{th})}{\sqrt{2}\sigma} \right]$$

- Where erfc is the complementary error function and $P_0(R)$ is the median power at cell boundary with radius R .

Computation of Fading Margin

- The median power at distance r can be expressed as:

$$P_0(r) = P_0(R) \left[\frac{R}{r} \right]^\nu$$

– where ν is the loss parameter.

- Hence outage probability at distance r can be expressed as:

$$P_{out}(r) = \frac{1}{2} \operatorname{erfc} \left\{ \frac{\ln \left[\left(\frac{P_0(R)}{P_{th}} \right) \left(\frac{R}{r} \right)^\nu \right]}{\sqrt{2}\sigma} \right\}$$

Computation of Fading Margin

- The area outage probability is given by integral:

$$P_{aout}(R) = \frac{1}{\pi R^2} \int_0^R P_{out}(r) 2\pi r dr$$

- The integral can be evaluated to:

$$P_{aout}(R) = \frac{1}{2} \operatorname{erfc}(Q_1) - \frac{1}{2} e^{(2Q_1Q_2 + Q_2^2)} \operatorname{erfc}(Q_1 + Q_2)$$
$$Q_1 = \frac{\ln\left[\frac{P_0(R)}{P_{th}}\right]}{\sqrt{2}\sigma}, \quad Q_2 = \frac{\sqrt{2}\sigma}{\nu}$$

Computation of Fading Margin

- The fading margin M [dB] can be written as:

$$M = 10[\log_{10}P_0(R) - \log_{10}P_{th}] \text{ dB}$$

- Fading margin M can also be written as scaling factor m :

$$M = 10\log_{10}\left[\frac{P_0(R)}{P_{th}}\right] = 10\log_{10}(m)$$

- And the parameter Q_1 can be written in terms of fading margin M :

$$Q_1 = \frac{\ln(10^{M/10})}{\sqrt{2}\sigma}$$

Outage probability & fade margin

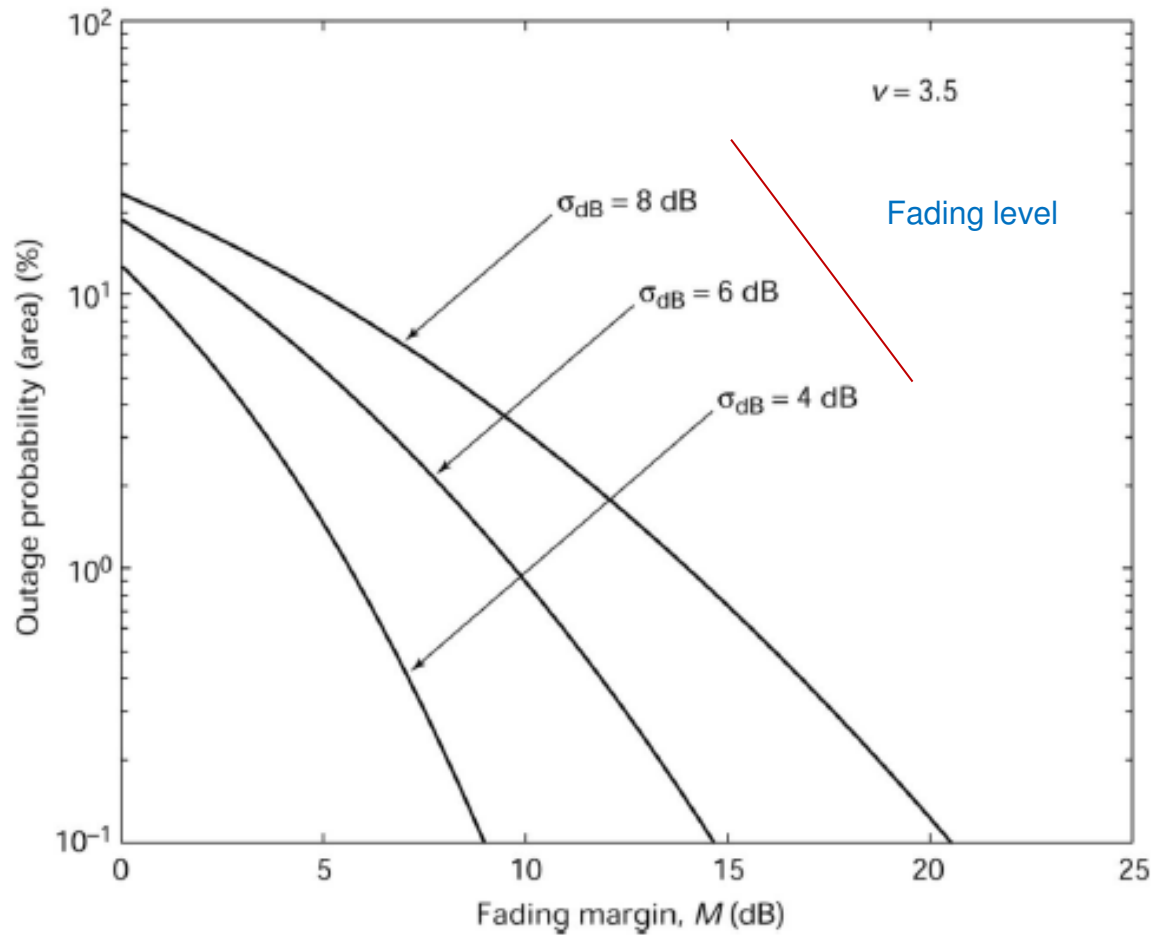

Outage goes up as fading level increases (at fixed fade margin)

Power margin required to maintain a fixed outage goes up as the fading level increases

Link budget

- To calculate maximum coverage (cell) based on minimum power (received) required to maintain acceptable performance
- Two fade margins (to mitigate fading):
 - Long-term fading, M_1
 - Short-term fading, M_2
- d_0 , maximum coverage based on only attenuation (distance dependent)
- d_1 , considers long-term fading effect
- d_2 , considers short-term fading effect

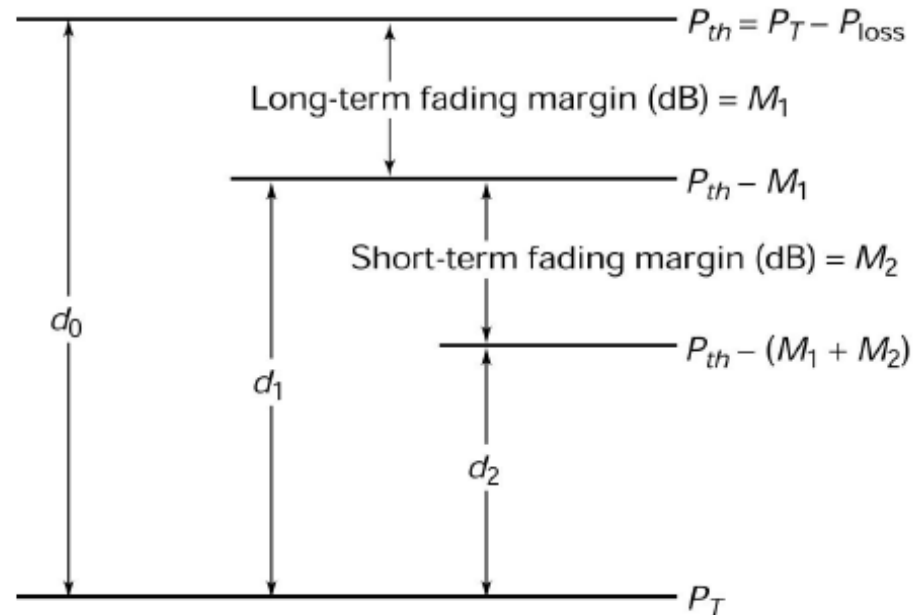

Example

- Example 4.5
- In a cell, the received power measured at a distance of 6 km from the BS is -65 dBm. The threshold level for acceptable performance is -90 dBm. If the power margin is 4.3 dB, what is the distance that can be covered? Assume that the path loss exponent is 3.2.

Cells and Cellular Traffic

- Introduction
- Hexagonal Cell Geometry
- Co-Channel Interference (CCI)
- CCI Reduction techniques
- Cell Splitting
- Hierarchical Cell Structure
- Coverage Area Estimation
- **Traffic Capacity and Trunking**
- Adjacent Channel Interference
- Summary

Traffic Capacity

- How to compare the quality of service by various cellular operators?
 - What is the probability of not being able to make a call when tried?
 - What is the probability that one has to wait to get connected?
- Answer lies in the concept of 'Trunking' and 'Grade of Service (GOS)'

Trunking and Grade of Service

- **Trunking:** There are more users than there are available channels (trunks), based on the assumption that not all going to try to set up a call at the same time. Trunking allows to accommodate a large number of users using a limited bandwidth.
- **Grade of Service (GOS):** However, problem arises when everybody in the system willing to make call at the same time. Only limited number of them allowed and the rest are blocked.
- GOS is a measure of the probability of blocking. It is the ability of the user to gain access to the system during the busiest hour. To understand GOS traffic intensity needed to be defined

Traffic intensity

- The traffic intensity generated by a user, A_I :

$$A_I = \lambda T_H \text{ Erl}$$

- λ is the average number of calls/hr
- T_H is the duration of the call (hr)
- For K users/operator:

$$A_{tot} = KA_1 = K\lambda T_H \text{ Erl}$$

Example

- A person is using the phone at a rate of 2 calls/hr and stays on the phone for an average time of 3 minutes per call. What is the traffic intensity generated by this user?

Offered traffic

- To achieve a certain performance (blocking probability), the operator must provide a certain number of channels or trunks:

$$p(B) = \frac{\frac{A^C}{C!}}{\sum_{k=0}^C A^k / k!}$$

- A is the offered traffic: $A = \frac{\Lambda}{\mu}$
 - Mean rate of call arrival: Λ
 - C is the number of available channels
 - The mean duration of a call: $1/\mu$
 - The carried traffic: $A_c = A[1 - p(B)]$
 - The channel efficiency: $\eta = \frac{A_c}{C} = \frac{A[1-p(B)]}{C}$
- The calls arrival can be modeled using a Poisson process (events occur continuously and independently of one another)
 - The duration of calls is exponentially distributed

Channel or trunking efficiency

- Efficiency increases if C increases

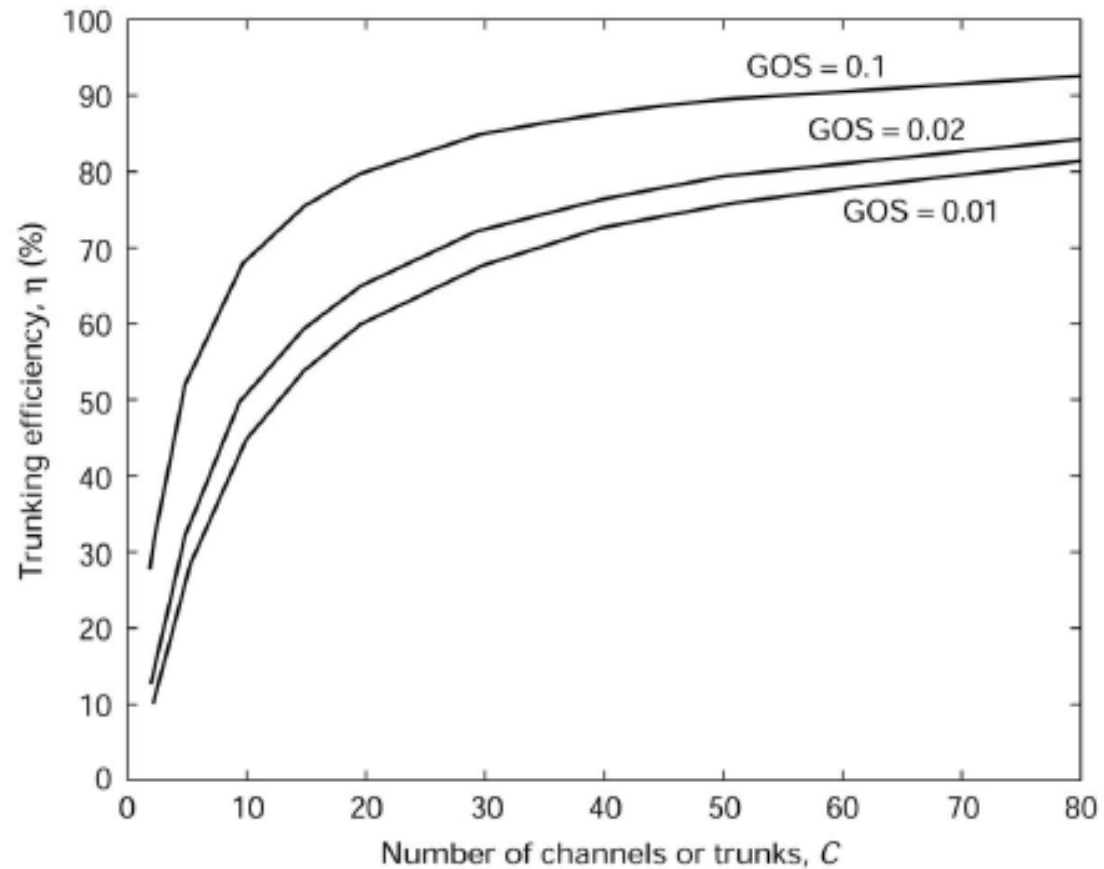

Example

- Example 4.6: If an operator has 50 channels available, how many users can be supported if each user makes an average four call/hours, each call lasting an average of 2 minutes? The GOS is 2%.
- Answer: $p(B) = \text{GOS} = 0.02$
- From Erlang B (table 4.3), the offered traffic with 50 channels for a blocking probability of 0.02:
 - $A = 40.255 \text{ Erl}$
- The carried traffic is:
 - $A_c = A[1-p(B)] = 40.255 * 0.98 = 39.445 \text{ Erl}$
- The traffic generated by each user: $A_i = \text{Calls/hour} \times \text{call duration} = 4 * 2/60 = 0.1333 \text{ Erl}$.
- Maximum no of subs that can be supported:
 - $39.445/0.1333 = 296$

Example

- Example 4.7:
- Two service providers, I and II, are planning to provide cellular service to an urban area. Provider I has 20 cells to cover the whole area, with each cell having 40 channels, and provider II has 30 cells, each with 30 channels. How many users can be supported by the two providers if a GOS of 2% is required? Omnidirectional antennae will be used. Assume each user makes an average of three calls/hour, each call lasting an average of 3 minutes.

Trunking efficiency Omni Vs Sector antenna

- Signal to Interference (CCI) ratio increases by using sectored cells
- $S/I(120) < S/I(60)$
- But at what cost?
- Using of sectors lowers trunking efficiency!

Trunking efficiency Omni Vs Sector antenna

- Number of channels per cell = 56, GOS = 2%
- Omni
- No. Of channels/sector = 56
- Offered traffic (at GOS 2%) = 45.87 Erl (Erlang B table, pp. 158-159, course book)
- Carried traffic = $45.87 \times 0.98 = 44.95$ Erl
- Trunking efficiency = $44.95/56 = 80.3\%$

- 120 degree sector
- No. Of channels/sector = $56/3 = 19$
- Offered traffic (at GOS 2%)/sector = 12.34 Erl (Erlang B table)
- Carried traffic/sector = $12.34 \times 0.98 = 12.09$ Erl
- Carried traffic/cell = $12.09 \times 3 = 36.28$ Erl
- Trunking efficiency = $36.28/56 = 64.8\%$

Trunking efficiency Omni Vs Sector antenna

- 60 degree sector
- No. Of channels/sector = $56/6 = 9$
- Offered traffic (at GOS 2%)/sector = 4.35 Erl (Erlang B table)
- Carried traffic/sector = $4.35 \times 0.98 = 4.26$ Erl
- Carried traffic/cell = $4.26 \times 6 = 25.58$ Erl
- Trunking efficiency = $25.58 / 56 = 45.7\%$

Cells and Cellular Traffic

- Introduction
- Hexagonal Cell Geometry
- Co-Channel Interference (CCI)
- CCI Reduction techniques
- Cell Splitting
- Hierarchical Cell Structure
- Coverage Area Estimation
- Traffic Capacity and Trunking
- **Adjacent Channel Interference**
- Summary

Adjacent Channel Interference (ACI)

- ACI is caused primarily by inadequate filtering and nonlinearity of the amplifiers
- In most cases, it is sufficient to take under consideration only the interference coming from the two channels on either side of the primary channel.
- ACI is typically attenuated by the receiver filter whereas CCI is unaffected

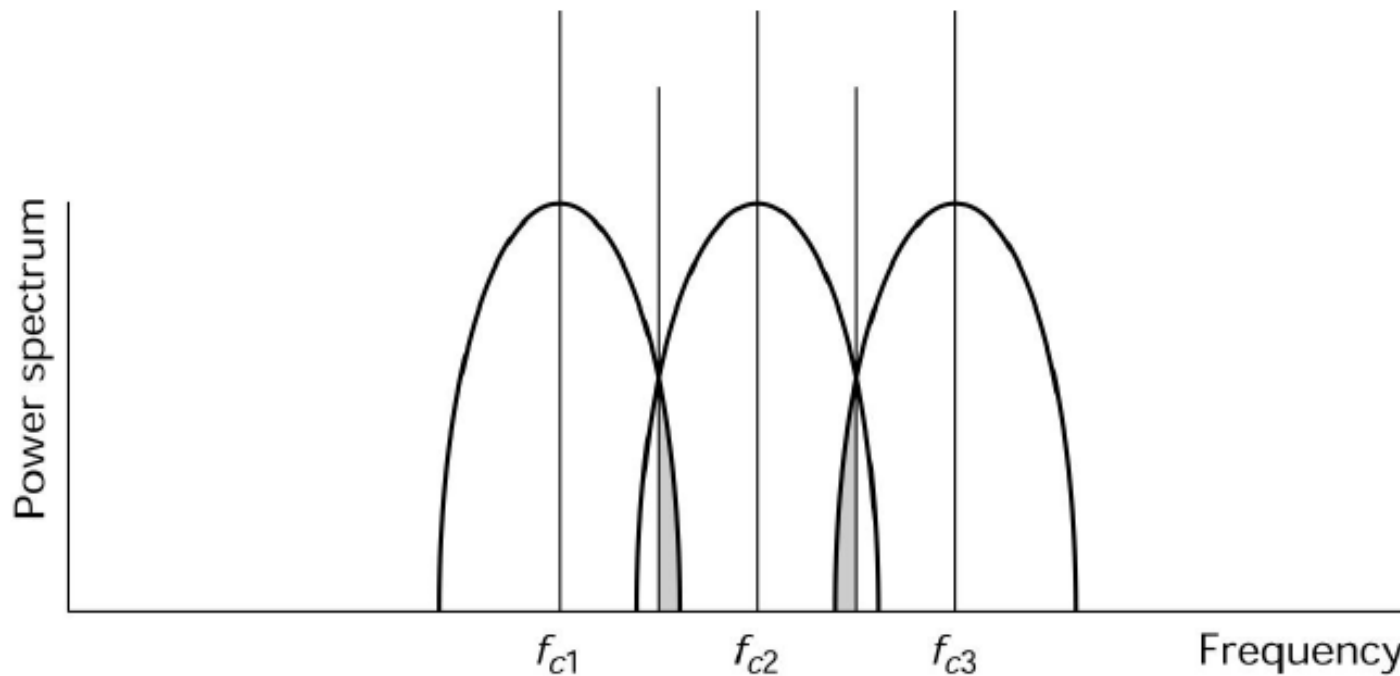

Adjacent Channel Interference (ACI)

- ACI ratio can be expressed as:

$$ACI\ ratio = \frac{\int_{-\alpha}^{\alpha} G(f) |H_B(f - \Delta f)|^2 df}{\int_{-\alpha}^{\alpha} G(f) |H_B(f)|^2 df}$$

- where $H(f)$ is the transfer function of the bandpass filter and Δf is the channel separation. $G(f)$ is the power spectral density function
- The overall performance of the cellular system is total signal-to-interference ratio:

$$\left(\frac{S}{I}\right)_{tot} = \frac{S}{CCI + ACI}$$

-

Cells and Cellular Traffic

- Introduction
- Hexagonal Cell Geometry
- Co-Channel Interference (CCI)
- CCI Reduction techniques
- Cell Splitting
- Hierarchical Cell Structure
- Coverage Area Estimation
- Traffic Capacity and Trunking
- Adjacent Channel Interference
- **Summary**

Summary

- Hexagonal structure is the optimal cell shape
- The signal-to-CCI ratio S/I improves as the number of cells in the pattern goes up
- CCI reduction/frequency reuse factor q is given by D/R , where R is the radius of the cell. Higher values of q result in lower values of interference
- Sector antenna reduce interference since the number of interfering cells goes down as the number of sectors goes up
- Capacity can be increased through cell splitting
- For a given spectral width (a given set of frequency channels), more channels per cell means smaller cluster size
- Smaller cell means lower transmission power
- Smaller cell => More reuse => more capacity ----- good for city centers
- Larger cell => Fewer base stations, but less capacity ----- good for rural areas

Summary

- Larger cells preferred for high-speed traffic in order to reduce frequent handover
- High-speed traffic through high-call area => overlay cell (more than one cell at a place; one is larger than the other)
- Traffic volume per cell together with required GOS (Grade of Service) sets the minimum channel requirements
- GOS is a measure of the ability of a user to gain access to a channel during busiest period

Problem

- Course Book: chapter 4
- Problem: 2, 7, 8, 12, 20

Problem

- Problem 2: In a cellular communication system, the signal power received is -97 dBm. The structure is a seven-cell pattern. The noise power is -117 dBm and each of the interfering signals is -120 dBm.
- Calculate the overall signal-to-noise ratio
- Calculate the signal-to-CCI ratio
- If a 20 dB signal-to-CCI ratio is required, what should be the power of the signal from each of the interfering cells?

Problem

- Problem 7: For acceptable performance, the signal-to-CCI ratio must be at least 20 dB. What must be the value of D/R ? Assume v to be equal to 3.0.

Problem

- Problem 12: Two service providers, A and B, provide cellular service in an area. Provider A has 100 cells with 20 channels/cell, and B has 35 cells with 54 channels/cell. Find the number of users that can be supported by each provider at 2% blocking if each user averages 2 calls/hour at an average call duration of 3 minutes.

Problem

- Problem 20: Based on the Hata model for power loss, it has been determined that there is approximately 0.7 dB/km loss in the range of 10-18 km from the transmitter. The long-term fading margin is 6 dB and the short-term fading margin is 4 dB. Calculate the reduction in transmission distance when
 - a) Only the long-term fading margin is factored in.
 - b) Only the short-term fading margin is factored in.
 - c) Both fading margins are into account.