

UNIVERSITY OF OSLO
Department of Informatics

**Energy
Consumption In
Wireless Sensor
Network**

Shabnam Pirnia

November 16, 2010



Abstract

Wireless Sensor Network (WSN) is a promising technology and due to its multitude applications such as remote monitoring, personal medical monitoring and home automation, it has become one of the most interesting tasks in the recent years.

A WSN consists of many sensor nodes which sense physical phenomena or collect data from an environment.

Depending on a predefined application of a network, sensor nodes can be located in fixed places or distributed randomly over a large geographical area. Their communication with each other occurs wireless and they share a channel for signal transmission. Some parameters such as position, distance, power consumption for each node and communication technology between sensor nodes have inevitable impact over the network's performance.

In spite of a tremendous development, there are still limitations that WSNs suffer. Some challenges like designing a low power network, data security and architecture of network have taken the most attention of researchers in the last years.

The energy consumption is one of the most common problems in the wireless sensor network that does not appear in more traditional wired sensor network. Each sensor node is battery operated and it makes a wireless sensor network highly depended on each node battery. It is very important to predict the lifetime of a wireless sensor network before network installation.

Our work will be based on analysis of a communication protocol (ZigBee) when the network forms Star and Mesh topologies.

The monitor of greenhouse condition is the main concept in our work. The temperature will be measured with sensor nodes, and the sensed data will sent to a remote center. We are looking for the best and most suitable topology in term of low power consumption for this scenario.

Contents

Abstract	i
1 Introduction	1
1.1 Motivation	3
1.2 Outline of thesis	4
1.3 Why are wireless sensor networks different	6
2 Wireless Sensor Network	8
2.1 Architecture of wireless sensor networks	9
2.2 Different topologies in wireless sensor networks	13
2.2.1 Star	15
2.2.2 Mesh	15
2.3 Applications of wireless sensor networks	16
2.4 Classification of Sensor Network Applications	18
2.5 Challenges at wireless sensor networks	20
2.6 Summary	21
3 Radio and MAC properties	22
3.1 IEEE 802.15.4	23
3.1.1 IEEE 802.15.4 Physical Layer	23
3.1.2 IEEE 802.15.4 Devices	25
3.1.3 IEEE 802.15.4 Medium Access Control (MAC) Layer	26
3.2 ZigBee	28
3.2.1 Advantages Of ZigBee	30
3.2.2 Network Topology	32
3.3 Zigbee Standard Overview	36
3.3.1 ZigBee Devices	36
3.4 ZigBee Applications	37

3.5	Some previously ZigBee simulations	39
3.6	Zigbee Routing Layer	39
3.7	Chapter Summary	40
4	Energy Saving In Wireless Sensor Network	42
4.1	Energy saving at node	42
4.2	Energy saving at MAC layer	46
4.2.1	Time Division Multiple Access (TDMA) protocol . . .	46
4.2.2	Sensor MAC (S-MAC)	47
4.3	Energy saving at Network Layer	47
4.3.1	Communication protocols for wireless sensor networks .	48
4.4	Summary	49
5	Wireless Sensor Network In Greenhouse	50
5.1	Effects of wireless sensor network technology in Agriculture . .	51
5.1.1	Advantages of WSN in greenhouse	52
5.2	Literature overview	53
5.3	The challenges in the agriculture	58
5.4	The goal of simulation	59
5.5	Our scenario model	59
5.6	Technological model	61
5.6.1	System Architecture	63
5.6.2	Network Hardware	64
5.7	Summary	67
6	Energy waste in wireless sensor network	68
6.1	Data Collision	68
6.1.1	The Algorithms For Avoidance Of Data Collision . . .	71
6.1.2	Energy Consumption	71
6.2	Analysis Of Data Collision	73
6.2.1	Packet length and Received Power	73
6.2.2	My Case	74
6.2.3	Simulation	74
6.3	Summary	79
7	Simulation	81
7.1	Principle Aspects	81
7.2	Network topology	82

7.3	Technical Aspects	85
7.3.1	Location of sensor nodes	87
7.4	Methods	90
7.4.1	Data routing in Star	91
7.4.2	Data Routing in Mesh	91
7.5	Energy consumption calculating	94
7.6	Results	95
7.7	Summary	101
8	Evaluation	102
8.1	Analysis	102
8.2	Conclusion	104
9	Referances	105
9.1	Appendix A	111
9.2	Appendix B	130
9.2.1	CC2400	130

List of Tables

4.1	MSP430 properties [36]	46
4.2	Lifetime comparison of network for different routing algorithms [36]	49
5.1	Different chips from Texas Instrument	66
6.1	The received power and distance between 6 nodes for transmitt power of 0 dBm.	75
6.2	The received power and distance between 6 nodes for transmit power of -15 dBm.	75
6.3	The received power and distance between 6 nodes for transmit power of -25 dBm.	75
6.4	The probability for data collision versus the packet length for 5 nodes	78
6.5	The probability for data collision versus the packet length for 8 nodes	78
6.6	The probability for data collision versus the packet length for 10 nodes	78
6.7	The probability for data collision versus the number of nodes.	79
7.1	The properties for CC2420 [51]	86
7.2	The coordinat of sensor nodes in greenhouse.	88
7.3	The current consumption in CC2420 [51]	90
7.4	The result for Star topology for 17.4 mA current consumption of cc2420	95
7.5	The received power for PAN in Star topology for 17.4 mA current consumption of cc2420	95

7.6	The result for Mesh topology for 17.4 mA current consumption of cc2420	97
7.7	The power consumption for Star and Mesh topologies with current consumption 17.4 mA for cc2420.	97

List of Figures

1.1	Wireless Sensor Network [11]	3
2.1	An illustration of different layer in wireless sensor network [47]	12
2.2	Different basic network topologies [49]	14
2.3	An overview of WSN applications, has updated from [5].	17
3.1	The different frequency bands, has updated from [46]	24
3.2	The 7-Layers of OSI Communication, has updated from [32]	27
3.3	ZigBee, Bluetooth and WiFi, has updated from [46]	29
3.4	The Communication Model Adapted to a ZigBee Stack, has updated from [32]	30
3.5	Different network topologies which have supported with ZigBee [9]	35
3.6	ZigBee and communication technologies [46].	38
3.7	The advantages and disadvantages of Star, Mesh and Tree topologies, has updated from [28]	41
4.1	Some selected nodes form Texas Instruments Company and their proprieties	44
5.1	A greenhouse model [15]	54
5.2	A greenhouse model [20]	56
5.3	A model of greenhouse in the [21]	57
5.4	A simple model of our scenario.	60
5.5	The communication between nodes in the network	62
5.6	The basic units of a sensor node [24]	65
6.1	Beacon transmission in Star topology, is updated from [30]	70
6.2	The probability for bit error versus the power received	76

LIST OF FIGURES

7.1	Time and power transition for chip cc2420 [30].	86
7.2	The data routing algorithm in Star.	92
7.3	The data routing algorithm in Mesh.	93
7.4	Power consumption for each node in Star topology	96
7.5	The standard variation for a Star network.	98
7.6	Power consumption for each node in Mesh topology	99
7.7	The standard variation for a Mesh network.	100

Acronyms

WSN	Wireless Sensor Network
BS	Base station
TDMA	Time Division Multi Access
MANET	Mobile Ad-Hoc Network
VANET	Vehicular Ad Hoc Network
PHY	Physical Layer
SER	Symbol Error Ratio
MAC	Media Access Control Layer
CSMA	Carrier Sense Media Access
CCA	Clear Channel Assessment
IP	Internet protocol
RF	Radio Frequency
DSSS	Direct Sequencing Spread Spectrum
DC	Direct Current
FFD	Full Function Device
RFD	Reduced Function Device
QoS	Quality of Service
ZD	ZigBee Device
ZC	ZigBee Coordinator
ZE	ZigBee End
DSDV	Destination Sequenced Distance Vector
DSR	Dynamic Source Routing
SMS	Short Message Service
RSSI	Received Signal Strength Indicator
SOC	System On Chip
EOF	Electromagnetic time-of-flight
RADAR	Radio Detection and Ranging
TI	Texas Instruments
RTS	Request To Send
CTS	Clear To Send
NAV	Network Allocation Vector
RREQ	Route Request
RREP	Route Reply
AODV	Ad hoc On-Demand Distance Vector
LEACH	Low Energy Adaptation Clustering Hierarchy
PEGASIS	Power Efficient Gathering in Sensor Information System

LIST OF FIGURES

OQPSK Orthogonal Quadrature Phase Shift Keying

BPSK Binary Phase Shift Keying

Acknowledgments

I would like to thank my supervisor, Prof. Dr. Josef Noll for his support. He is a skilled, knowledgeable and great person. I had a very educational period during my work. Thanking all friends, especially Malihe Zarre for her help. The last great thank to my family, my husband and sons who supported me all the time.

Chapter 1

Introduction

Advances in Hardware and Software technologies had given us the ability to be informed about our environment anytime. The small wireless devices will provide access to these information.

The Wireless Sensor Networks (WSNs) are becoming one of the most cost effective solutions to monitor a physical environment. Research on WSNs has progressed dramatically in the past decade. The information needed here is provided by Distributed Wireless Sensor nodes, which are responsible for sensing.

Each sensor network is developed to serve its specific purposes. Modern wireless networking technologies had enabled many sensor nodes to communicate with each other in a network and with the outside world.

The term wireless is used since most sensor nodes in sensor networks are connected to each other wireless and they share a common medium for data transferring among themselves. Bluetooth is one of the possible communication technologies within wireless networks.

Nowadays sensors have been integrated in most buildings and homes for different purposes. Some are used in alarms and warning systems for fire or to apply security applications for house owners.

The integration of sensor nodes into industry, different environments and structures has some benefits for our society. Fewer catastrophic failures, conservation of natural resources, improved manufacturing productivity, enhanced emergency response and home security can be mentioned as some examples of sensor networks benefits.[19]

A Wireless Sensor Network (WSN) is a group of special transducers (sensors) for monitoring a physical phenomena, like temperature, sound, light

intensity, location, moisture, motion of objects and so on. Many inexpensive and low data rate wireless sensor elements, each with computational power and sensing ability had planned for a wide range of applications.

These applications varies from surveillance systems, motorway traffic observing, habitat monitoring, detection of forest fire, tracking of enemy in military applications, seismic sensing to environmental applications.

The sensor nodes have the responsibility of detecting events, data gathering and data transferring to the upper layer in network. These are battery-operated devices and are capable for measuring physical parameters, exchange data with each others, data storage and process signals. They are working together to monitor a region to obtain data about the environment.

The environment condition plays a key role in determining the network size e.g. indoor environments need only a few nodes, while the monitoring an outdoor area requires many sensor nodes. The obstacles in environment can limit the communication range and affect the connectivity between nodes.

The goal of a sensor network is to produce high quality information about a large geographical area and provide a better service to the end users.

The sensor nodes can spread randomly over area or can be located in fixed places to monitor an environment. The basic promise of WSN is to sense physical events or monitor an environment with lower cost in a reliable way.

The goal of this job is to analyze different network topologies namely, the Star and Mesh topologies.

We are looking for the best solution in term of energy consumption for achieving a low power sensor network.

In recent years, ZigBee is considered to be one of the optimal communication protocols for wireless sensor network in term of low energy consumption, low cost and reliability.

Our work includes analyzing the ZigBee protocol in term of energy consumption in the different network topologies.

In this thesis, we have tried to describe some primary concepts of sensor networks, theirs properties and different layers in wireless sensor network's architecture.

This chapter has aimed to give the reader some general understanding of wireless sensor network.

These is an illustrations of Wireless Sensor Network in the real world.

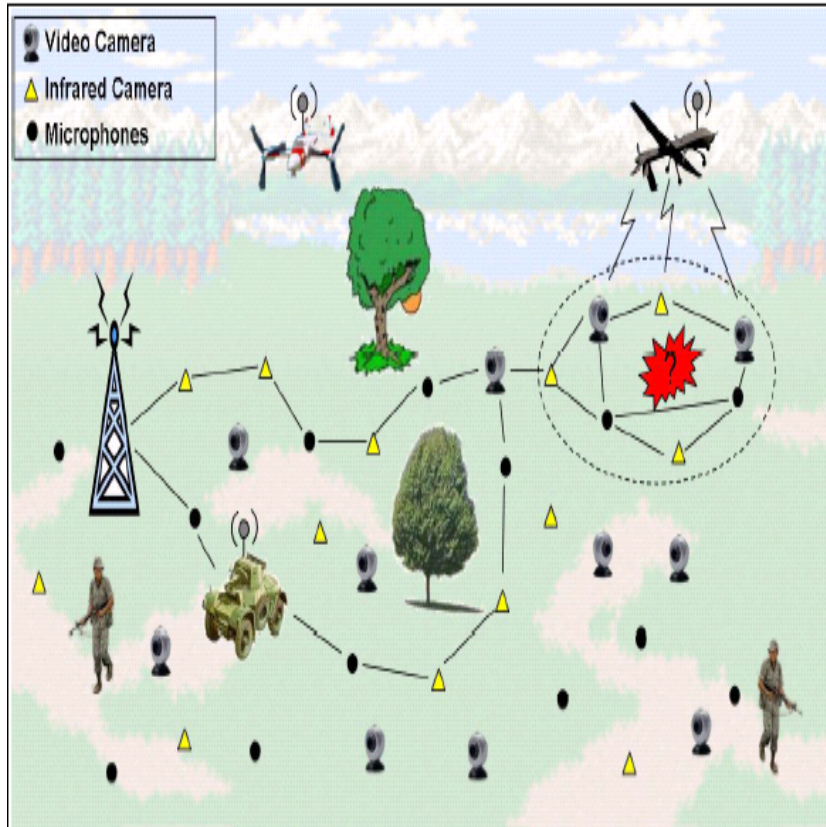

Figure 1.1: Wireless Sensor Network [11]

In figure 1.1 have included several sensor nodes in the microphones and cameras which each measures some specific physical environmental parameters.

1.1 Motivation

People are always in motion and they want to have contact with each other throughout the world. The increasing amounts of information, the need for fast, effective and accurate information are forcing development of new methods of transmission and receiving of data.

One of the challenges is to gathering data and analysis of collected data. In a hypothetical situation, the data can be collected from sensor nodes that are placed in a given environment and these data can be sent to another center to analyze.

Many researchers are working with issues such as detection of the correct data, transmission of data and processing the data. There are many challenges such as lifetime of energy sources, defining a suitable architecture for communication in a network, security, connectivity and etc.

The multitude of applications that can be offered with wireless sensor network in the digital world had made such network very interesting for many scientists throughout the world. These applications are based on the collected data from different sensor nodes in a network. This is the reason to my motivation for this thesis.

1.2 Outline of thesis

Our work consists of the three parts. In the first part, we will try to get acquainted with wireless sensor network. For this we consider the brief overview of wireless sensor network in three chapters, namely in the Wireless Sensor Network, Radio and MAC properties and in the Energy Saving In Wireless Sensor Network chapters.

After that, we take analysis the challenges of our work, namely how can be saved energy in wireless sensor network.

A simple model of the model of the Green House will be present. The technical parameters coming in the mirror in this part. These points have been explained in scenario chapter.

The final part of our work will include our method to solve the problem and discussing of results. At the end, we will conclude our analysis in conclusion section. This part will explain that our work can contribute something related to future work and what is proposed.

The thesis is organized as follows:

Chapter 1 gives an overview of the thesis and the goal.

Chapter 2 gives an overview of wireless sensor network and its properties such as network architecture, topology, challenges.

Chapter 3 gives an overview of ZigBee protocol.

Chapter 4 introduces some energy saving methods based on previous literature.

Chapter 5 introduces our scenario, model and technical description of the problem.

Chapter 6 gives an overview of data collision in wireless sensor network.

Chapter 7 explains our solution of the problem.

Chapter 8 evaluates the results of simulation.

Chapter 9 gives a list over references.

1.3 Why are wireless sensor networks different

The difference between the wireless sensor network and other wireless technologies like Bluetooth and Mobile Ad-Hoc Network is discussed here.

- Bluetooth

Bluetooth and the mobile ad hoc network (MANET) are probably the closest communication technologies couple to the sensor networks. Bluetooth was initiated in 1998 and standardized by the IEEE as Wireless Personal Area Network (WPAN). It is an infrastructureless short-range wireless system where devices communicate with each other via RF links.

Bluetooth uses the unlicensed 2.4 GHz band with data rate 1Mb/s. The Bluetooth topology supports a Star networking form where a coordinator node can serve up to 7 slave nodes seamlessly connected to it. TDMA and frequency hopping are using in the Bluetooth for data transmission. Transmitted power is typically around 20 dB m and the communication range varies from few centimeter to 10 meters. [43],[10]

- Mobile Ad-Hoc Network

Mobile Ad-Hoc network (MANET), or mobile mesh network, is a collection of mobile devices with capability to communicating wireless with each other. The devices can form a Peer- to - Peer, multi-hop network without any need of an established infrastructure. Since the nodes are mobile, the network topology may change rapidly and unpredictably over time.

In MANET, all network activity including discovering the topology, forming the network infrastructure and data translating must be done by the nodes themselves. Factors such as wireless link quality, propagation path loss, signal fading, power consumption, and dynamical topology are some of the main considerations in MANET.[40],[43]

A VANET (Vehicular Ad Hoc Network) is an example of MANET on the road where cars can have communication with equipments that have placed at the roadside. Although the vehicles cannot have a direct connection to the Internet, they can send data to the roadside equipments. These devices have connection with the Internet and with the help of them the vehicle data can be transferred. The vehicle data may be used to measure traffic conditions or keep track of trucking fleets. [41]

Some key features of MANET are:

-
- Self configuring: there is no need for existing infrastructure.
 - Wireless radio links: uses radio link for data transferring.
 - Nodes are mobile: topology changes anytime.
 - Nodes are able to relay traffic to other places.
 - A MANET can be a standalone network or it can be connected to external networks (Internet). [22]

The rapid development of technology in low-powered, low cost electronic devices made evolution from the traditional ad hoc network to wireless embedded network. Sensor networks typically make use of ad-hoc networking, but there are some limitations which make them unable to utilize fully of many proposed ad-hoc network protocols.

Wireless sensor networks are similar to mobile ad-hoc networks(MANETs) where the multi-hop communications are used in the both. But a wireless sensor network is an embedded network which differs from traditional networks in several ways.

In contrast to Bluetooth and MANET, sensor network may have a much larger number of nodes. The transmission power (0 dB m) and radio range of a sensor node is much less than Bluetooth and the MANET. Because of node mobility and failure, the network form changing is more common in a sensor network. [43]

Sensor networks have limited energy resources. Unlike the MANET where devices are handled with human users and hence, power consumption is only of secondary importance, in the wireless sensor network energy is limited. Here the network lifetime highly depends on the lifetime of small nodes.

As physical size of nodes decreases, so does energy capacity. Therefore, wireless sensor networks are more suitable for low rate data where there is no need for more power for communication within the network. There is the reason that the sensor network must be managed even more carefully than MANET. [1]

The end-to-end routing algorithms that have been proposed for mobile ad-hoc networks are not appropriate under these setting, the typical mode of communication in sensor network occurs in a multi-cast fashion (from many-to-one). There is a probability for having a redundancy of data, since the data begin collected by multiple sensors which had planned to sense a common phenomena.[1]

Chapter 2

Wireless Sensor Network

The combination of sensing, processing and communication interface offer thousands of potential applications which is the main concept of wireless sensor network. [11]

The wireless sensor nodes are self contained units consisting of an energy source, RF-capabilities, computing power and an actuator or sensor. They can communicate among each other, collect data from their surrender or connect to an external base station or remote center. [6]

The following are some properties of wireless sensor networks :

- Self-organizing

The sensor nodes can spontaneously create the network and position of nodes need not be predetermined. A self-organizing sensor network has no need to link into an established network and data are coming to translate automatically data between nodes and destination.

- Short range communication and multi-hop routing

Multi-hop communication in wireless sensor networks is expected to consume less power than the traditional single hop communication. As we know, the required transmission power increases with the distance between transmitter and receiver. Consequently, many short hops require less energy than one long hop.

- Cooperating of sensor nodes

Because of the limited resources of the nodes, different roles had been given to nodes in the network for achieving a low power network.

- Dynamically changing topology

In wireless sensor network, nodes will fail and drop out of the network or new nodes may be added into the network. Hence, the network topology will be dynamic anytime.

- Limited energy resources, computational power and memory

Since a wireless sensor network is composed of small devices, the network suffers from resource limitation e.g. energy, computational power and memory.

2.1 Architecture of wireless sensor networks

Different layers of wireless sensor network's architecture have been explained in this section. These layers contain different features and are planned for providing different purposes.

- The Physical Layer (PHY)

The main objective of this layer is events detecting, sensing a phenomena via sensor nodes in the network. This layer addresses for frequency selection, signal detection, modulation, demodulation of digital data, transmission, receiving and data encryption in transceivers (sensor nodes). The sending and receiving data via radio link occurs in this layer. quasi-orthogonal modulation technique for sending a signal.[28]

In the last decade, there has been an explosion in the sensory technology. Nowadays there are different types sensors available in the market. They range from simple sensors such as light, temperature and motion sensors to complex digital sensors like optical sensors. The most important challenge in the physical layer is providing a simple, low cost and robust transceiver architecture. [22]

As a result of many studies, a large amount of energy consumption in the sensor network can be saved by optimizing physical layer operations. An optimal modulation can reduce energy consumption in the nodes. Factors

such as path loss, signal fading, antenna properties and the environment conditions should be also considered.

Sensor nodes can be deployed either very close or directly inside a phenomenon which has aimed to observe. They can be installed in a busy motorway, at the bottom of an ocean for using in the oil industry, on the surface of an ocean during a tornado, in a battlefield beyond the enemy lines, in a home or a large building, in a large warehouse, attached to animals, attached to fast moving vehicles, and in a river moving with current. [43]

The Symbol Error Rate (SER) is also one of the critical factors which impact the amount of energy consumption in the physical layer.

With a high SER can be increased energy consumption in the physical layer, since the data must to be retransmitted to destination nodes. [42]

In the physical layer, sensor nodes risk to be defective, lost, damaged, or expired. The power management is some of the important tasks which control the power level of each node in the network. For example, the sensor node may turn off its radio after receiving a packet. The sensor node can also warn other nodes within its local area about its power level. When its power level falls below a threshold, it will broadcast that it cannot participate in data routing.[43]

- The Medium Control Access Layer (MAC)

In the wireless sensor networks, electromagnetic waves propagate in an unguided medium, commonly in free space. Consequently, the providing a clear channel for signal propagation is one the most inevitable tasks.

The MAC layer allows system to translate data throughout communication channels. In wireless networks, all devices share a common medium with each other to communicate. Since the environment is mostly noisy and sensor nodes can be mobile in some cases, data collision is one of the most common problems in such networks. Especially in the dense networks where many sensor nodes has been included. (The more sensor nodes, the more chance of data collision).

The data collision occurs when the two nodes are trying to send data simultaneously. In this situation the two sent packets can be interfered with each other and this can be lead to data loss.

The MAC layer will take the responsibility to ensure that the data will transfer in a safe manner and be able to minimize data collision among the nodes as well as possible.

Most MAC protocols are aimed for achieving two goals. The first is the creation of the network infrastructure. The MAC protocols must establish communication links for data transferring between sensor nodes. This gives the sensor network self-organizing ability. The second goal is equitable sharing resources between sensor nodes.[43]

One of the simplest MAC protocols is Carrier Sense Media Access (CSMA) where each transmitter first checks the communication channel before its data transmission. If the channel is busy, it waits for a short time. Afterwards it can send its data.[17]

The collected data from sensor nodes can be processed, stored or translated to upper layers namely network and applications layer.

- The Network Layer

The network layer objective is defining routing for data transferring among the sensor nodes in the network. It provides functionality such as dynamic network topology, addressing and discovering.

Routing protocols in WSNs differs from traditional routing protocols in several ways. There is not any Internet protocol (IP) addresses for sensor node. Therefore IP-based routing protocols cannot be used in a WSN. Resources limitation like energy limitation, bandwidth and capability must be met in protocols description for such networks.[5],[18]

A single network may consist of several interconnected sub-nets of different network topologies. Different network topologies require different routing protocol. In the Star topology, it's just a jump between sink and other nodes so it doesn't require very complex routing algorithm for data transmission.

In opposite to the Star, Peer to Peer topology requires more complex routing protocols. In such topology several nodes act as mediator nodes. These nodes shuttle the data from nodes within a local place to the destination node.

One of the important functions of the network layer is to provide inter-networking with external networks such as other sensor networks, control systems or Internet. [43]

- The Application Layer

Depending on the sensing tasks, different types of applications can be built in the application layer.[43]

Wireless sensor networks are able to offer many different type applications. It makes the application layer be highly depended on user interested issues. With other words, the architecture of a sensor network is developed to meet application requirements. A sensor network is aimed to serve predefined applications for end users.

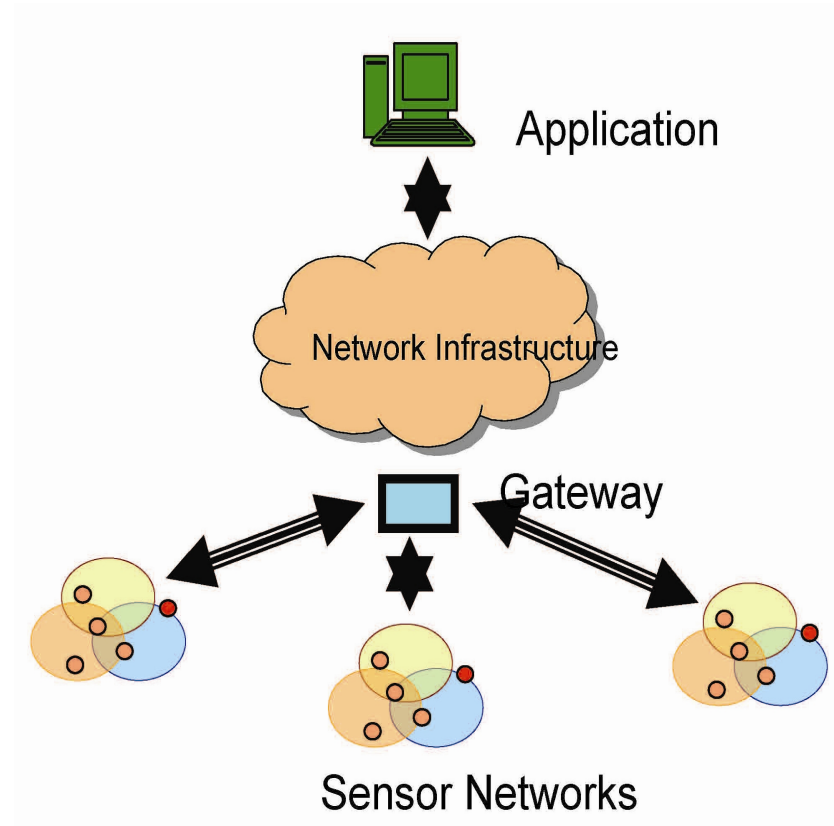

Figure 2.1: An illustration of different layer in wireless sensor network [47]

In the figure 2.1 gateway nodes gather data from sensor nodes and relay them to the base station. Gateway nodes have higher processing capability, battery power consumption, and communication range. A combination of sensor and gateway nodes is typically deployed to form a WSN. [5]

A wireless sensor network generally consists of a base-station (BS) or gateway that can communicate with a number of wireless sensor nodes via a radio link. The collected data from sensor nodes in the network can transmit to the BS directly or via intermediate nodes. A BS may be a fixed or a mobile

node which is able to connect the sensor nodes over a suitable architecture to a communication infrastructure or to the Internet where a user can have access to the collected data. This node has high computation capability for data processing and can link sensor network to other networks e.g. other sensor networks via a radio link. [19],[14]

2.2 Different topologies in wireless sensor networks

The basic aim in communication networks is the data exchanging between devices in the network with a predefined Quality of Service (QoS). QoS can be different in unlike cases. In some network, factors such as the data latency, bit error rate and packet loss are most desirable tasks that determine the network performance. While in other networks, the economic cost of transmission, transmission power, system stability can be considered as designing purposes.

The order of data flowing within nodes in the network is one of the most considerations for operating of communication systems.

The choice of the appropriate topology depends on the data rate, signal transmission distance, battery lifetime, the transmission environment conditions and the sensor node component. The different network topology are: ring, bus, tree, star and mesh. in the figure 2.2 on the following page shows the different network topologies. [7]

Ring

In this topology, data travel around a ring and if the ring is cut than all the system fails.

Bus

Here data broadcast on the bus to all devices. Each message constrains some information about destination which can be used by any device.

Tree/Hierarchical

Tree network topology is developed form of Star topology. In the Tree topology, system performance is highly depended on the routing algorithms. In such topology, some of the network's devices act as intermediary devices and must constantly be updated by its neighboring devices conditions.

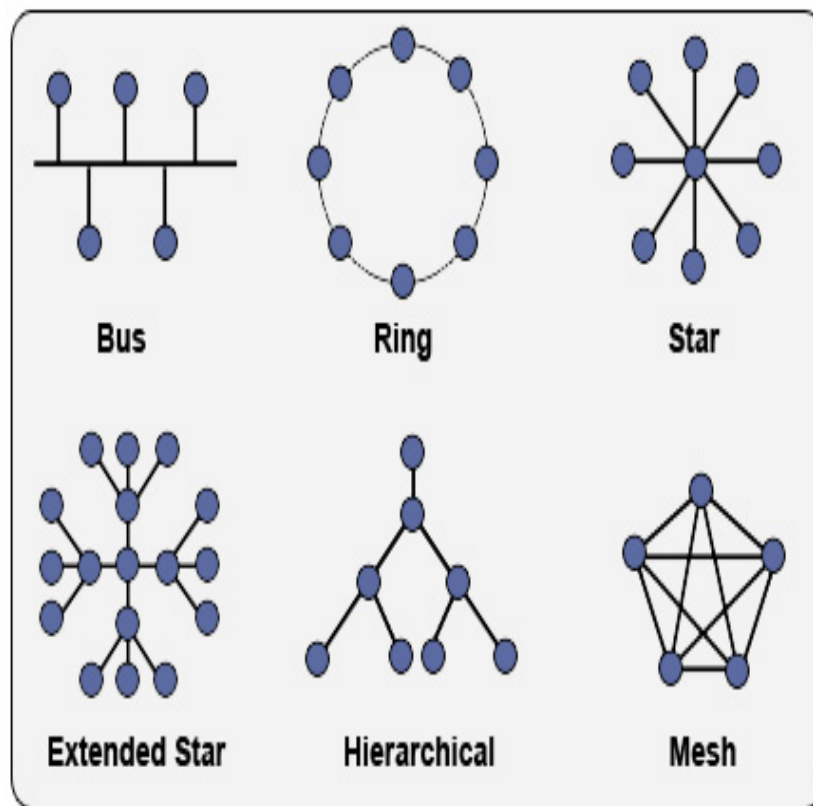

Figure 2.2: Different basic network topologies [49]

2.2.1 Star

The Star network topology is the most common topology where a single coordinator can send and receive data from a number of remote nodes. The remote nodes can only send or receive data from the network's coordinator; they are not able to communicate with each other. The Star network is usually used in home automation, personal computer, toys and games applications.

When a device such as FFD (Full Function Device) or RFD (Reduced Function Device) will to join the network, it sends request to coordinator of network. The coordinator has responsibility to confirm any request. The coordinator node has the main role in the network and therefore it uses more power to manage the network.

There are a limited number of nodes that a Star topology can support. Typically a coordinator can serve data for 7 nodes. The distance between nodes and the coordinator plays very important role. Due to the path loss exponent the received signal strength can be reduced which leads to error in the receiver side. That is why that kind of network topology is not suitable for large areas where there are a long distances between nodes.

2.2.2 Mesh

In Mesh topology, sensory data comes from several nodes in distributed locations. The communication occurs in the multi-hop fashion and it makes that the network be more robust for individual node failure than the Star form.

Each node in the multi-hop network can communicate with more than one node which makes a better overall connectivity in the network than in the Star topology.

Nodes exchange data among themselves in the network until data is received in destination node. It increases data amount for each node which lies closest to the sink node and makes that node requires more energy to data transferring to the sink. This is the why that in such network form the power level is not equal for all nodes. Some nodes die rapidly than the other but they can be replaced with other nodes which can take over their duties. [28]

Mesh network topology is suitable network form for large-scale networks of wireless sensor nodes which are distributed over a large geographic area, e.g. security surveillance systems and temporary environmental monitoring

applications.

One of the advantages of Mesh topology is its ability to expand. Unlike other systems where the service is denied or been of poor quality when there are many users, in Mesh topology link between nodes becomes stronger when there are many nodes in the network. A Mesh network can grow with many nodes to cover an unlimited area. With each node having a communication range of 50 meters and costing less than \$1 a sensor network that encircled the equator of the earth will cost less than \$1M.[11]

Some of characteristics of Mesh topology are as following:

- Self-forming

As nodes are powered on, they automatically can be added to the network. When two or more sensor nodes get connected, they form a network that can be joined later by the other nodes.

- Self-healing

It means when a node leaves the network (typically its battery drained), the remaining nodes changes their routes from the outgoing node to other nodes for ensuring a more reliable communication path.

- Multi-hop routing

The data from a node can jump through multiple nodes before delivering its information to a sink. [45]

2.3 Applications of wireless sensor networks

Jennifer Yik et al.[8] have classified wireless sensor networks applications into two categories: the monitoring applications and the tracking applications. An overview of their suggestion is shown in the figure 2.3 on the next page.

Holger Karl and Andreas Willing in [22], have described different types of WSN applications. Their classification is: terrestrial WSN, underground WSN, underwater WSN, multi-media WSN, and mobile WSN.

Some of the WSN applications are:

- Indoor/outdoor environmental monitoring:

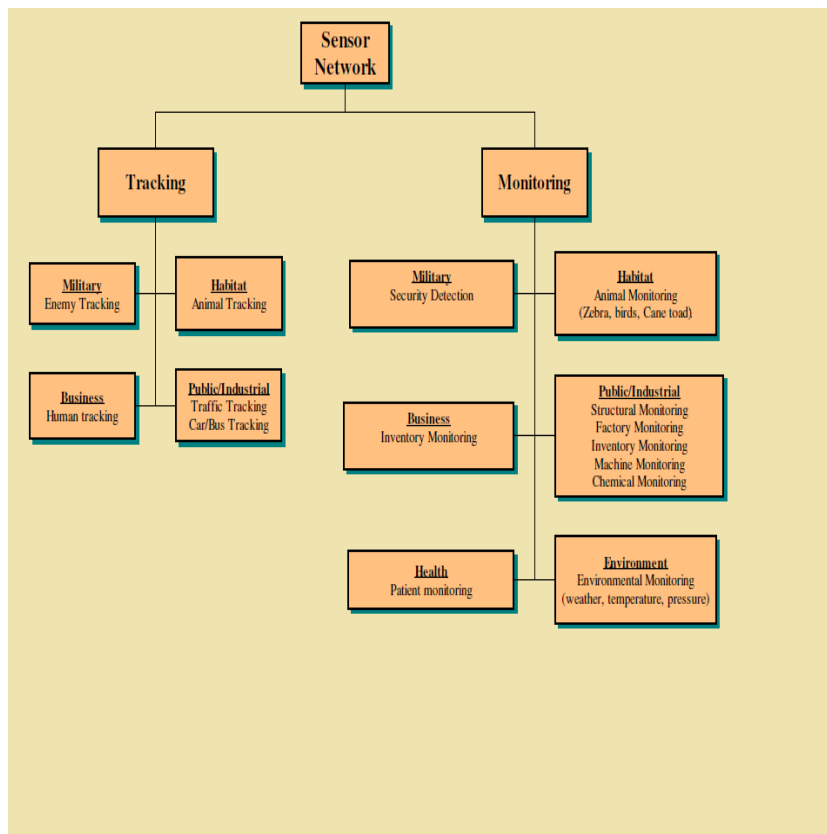

Figure 2.3: An overview of WSN applications, has updated from [5].

The wireless sensor nodes are used in houses for measuring the air temperature and detecting objects movements. In the most buildings, the density of smoke reports to an alarm center at the certain time. The smart lighting systems which uses sensors have been used for saving energy.

- Civil engineering

Sensor nodes could be integrated into the walls of buildings for detecting changes in the structural of buildings which can occur over the years or after earthquakes, extreme weather, fires and etc.

- Military applications

The sensor networks can be used to track enemy troops or vehicles. They can be designed to data gathering from environment for detecting enemy tanks.

- Health care

In the health and wellness monitoring systems, bio-sensor nodes can be used for surveillance of patients. Sensor nodes can be integrated on/in the body to detecting heart diseases.

- Infant monitoring

The sleep safe systems are designed for monitoring an infant while he/she sleeps to reduce sudden death syndrome of infants in many countries.

- Entertainment

Nowadays, toys have been integrated with motion sensors to be able to determine their location and also some sensors for detecting sounds from environment.[22]

2.4 Classification of Sensor Network Applications

The different application classes of WSN have included here.

- Event Detection and Reporting

Some of the applications in this class are detection of enemy in the military applications, detection of forest fires and security monitoring. In these type of applications the occurrence of the events is the most interesting task. Sensor nodes mostly are inactive and when an event occurs they will wake up and detect events then reports data to sink node and goes to sleep again.

Each node has to frequently check the environment conditions but it will not transmit data until an event happens.

In security networks reducing the latency of data transmission is significantly more important than reducing the energy cost of the transmissions. Reducing of the data latency needs high energy that causes the increasing of power consumption in such systems. [11]

- Data Gathering and Periodic Reporting

An environmental data collection application is which one wants to collect several sensory data from a set of points in an environment over a period of time. Of applications in this class can be described the home and building monitoring, air temperature monitoring for greenhouses, medical monitoring and so on.

A large number of nodes continuously sense and relay data to a base stations where the data can be stored and processed for further requirements. In such applications, the sending data rate is typically low which causes to prolonging of network lifetime. The typical network topology here is Tree form. The aggregated data is periodically passed from child node to parent node until the sink receives the data. Typical reporting periods are expected to be between 1 and 15 minutes. Such networks mostly contain many actuator nodes to control the events.

The requirements of environmental monitoring applications are long lifetime of network, low data rate, relatively static topology and better synchronization.[11]

- Sink-initiated Querying

In most monitoring applications sensor nodes deliver data to sink and sink must to ask all nodes about their measurements. When a node reports his data to sink, sink can query some specific set of nodes to obtain more information.

- Tracking-based Applications

The objective of these applications is to detect a tagged object's through a region monitored by a sensor network. The object initial position has been compared with its current position. Tracking involves several sensor nodes to follow the target especially if the target is moving.

Opposite to the other monitoring applications, here the sensing physical phenomena and collecting data are not of the consideration. The sensor nodes will be aimed to sense the radio messages of the nodes attached to various objects. The nodes can be used as active tags that announce the presence of a device and gives some information about object currently position. The node movement makes a dynamic network topology. [11]

2.5 Challenges at wireless sensor networks

This section describes some challenges in wireless sensor network. A wireless communication system requires a carefully management for the whole communication process, from sending a packet to correctly receiving at the receiver. The coding and modulation methods, receiving data, path loss and radio transmission are some of the challenges which wireless communication systems meet anytime.

- Wireless sensor network

For designing of a wireless sensor network, both the hardware and software part must be considered. The hardware part presents the structure of the nodes and their functions. The cost and size of a sensor node, battery lifetime, computation ability and node architecture belong to hardware challenges.

The software part presents the interface between networking nodes and the outside world. Detecting and recording of the events, routing protocols, formulating a meaningful user displays and evaluation of information to system performing can be considered as challenges in the software part. [44],[3]

Wireless sensor networks distinguish from the other wireless network for some reasons:

- Not global addressing scheme

A wireless sensor network includes too many sensor nodes. Therefore, it is not possible to address every node with a traditional IP address.

-
- Multiple data flowing

In contrast to typical communication networks, the data transmission occurs in a multiple fashion from nodes to a BS which is not possible in the other wireless communication network.

- Limited resources

Sensor nodes are highly limited in term of energy, processing, and storage capacities. Thus, they must be managed carefully.

- Application requirement

Designing a wireless sensor network highly depends on the system applications.

- Sensor node location

The environmental sensing demands a correct placement of each node, otherwise data collection will be difficult. Thus a position of sensor nodes is important for network performance. [14]

2.6 Summary

This chapter focused on wireless sensor network and their properties, challenges and applications. In this section, I have tried to summarize some important aspects of wireless sensor network.

The ultimate goals of wireless sensor network are data gathering any time and any place. It can be real time monitoring and control network, e.g. on body, in body, at home, at office, in industry and so on. The sensor networks have also ability to detect changes in the physical phenomena and environmental conditions by using many inexpensive, simple nodes to making a cost effective networks for data gathering.

The seamlessly interacting and communication with the environment and internal working in the network have made such networks more interesting.

When we are designing a low power WSN, we have to consider energy consumption, bandwidth, network topology, quality of communication link, data processing and scalability.

Chapter 3

Radio and MAC properties

A few years ago, there were only two standards in Personal Area Networks (PAN) aimed for seamless data transferring: Bluetooth and WiFi. These technologies were built for large bandwidth, high data rate, high power consumption. Their promise to deliver audio, video and file transferring had succeeded but in the cost of energy. [44]

In spite of technology development in the recent years that had created high-quality productions in the market, there is still a need for new standard that can meet the requirements such as low energy consumption, low cost systems.

In certain applications of the industry, it is imperative that sensor nodes spend low battery. The battery replacing and recharging is costly specially where there are hundreds sensor nodes in the network.

There is a need for cheaper hardware and software in term of designing a low power network. Such network requires inexpensive nodes, few processor and simple communication techniques. The self configuration network can also save a lot of system cost because of their self organization and management.

ZigBee is a new standard based on IEEE 802.15.4 which is optimal for remote control and wireless sensor networks. It mainly features are low data rate, low energy consumption and low cost.

This chapter deals with some technical description of ZigBee protocol and IEEE 802.15.4 standard. In this part, will emphasis on various network topologies, their advantages and disadvantages. At the end of chapter, the reader will be familiar with various network shapes and some properties of the ZigBee protocol.

3.1 IEEE 802.15.4

The Institute of Electrical and Electronic Engineer (IEEE) finalized the IEEE 802.15.4 standard in October 2003. The physical and MAC layers have been defined with this standard for Wireless Personal Area Network (WPAN).

Some of the most attractive applications of this standard can be mentioned like, applications in the area of wireless sensor networks, home automation, home networking, connecting devices to a personal computer (PC), home security and so on. [11]

The low rate data, low cost communication and low power consumption are the key points of this standard which mainly aimed to fulfill the most requirements of low power network applications like wireless sensor networks.

Generally this standard specifies the MAC layer and the physical layer for Low-Rate Wireless Private Area Network(LR-WPAN) but it is also suitable for sensor networks since the sensor network can be built up from LR-WPAN.

The LR-WPAN primarily intended for low-range communication and the main goal is to connect devices at short distances of 10 meters or less within the Personal Operating Space (POS). The IEEE 802.15.4 is associated with ZigBee protocol which is specified in December 2004 by ZigBee Alliance group.

ZigBee defines the layers above IEEE 802.15.4 namely the network and the application layers. IEEE 802.15.4 supports two network topologies: Star and Peer-to-Peer topologies.

3.1.1 IEEE 802.15.4 Physical Layer

Generally, transmission, modulation and spreading of data happen here. Some of the key characteristics of the PHY layer are:

- Activation and deactivation of the transceiver.
- Estimation of the received signal strength on a given channel (Energy detection(ED)).
- Computing Link quality (LQI)
- Sending and receiving data throughout the available radio channel (the different radio frequencies). [28]

IEEE 802.15.4 operates on the three frequency bands:

- Global use: ISM 2.4 GHz band with 16 channels between 2.4 and 2.4835 GHz.
- USA and Australia: 915 MHz band with 10 channels between 902 and 928 MHz.
- Europe: 868 MHz band with single channel between 868 and 868.6 MHz.[14]

	Frequency Band	Frequency	Wavelength
LF	Low Frequency	30 K Hz-300 K Hz	10 Km - 1Km
MF	Medium Frequency	300 K Hz- 3M Hz	1Km – 100 m
HF	High Frequency	3 MHz- 30 MHz	100 m -10 m
VHF	Very High Frequency	30 M Hz-300 M Hz	10 m - 1 m
UHF	Ultra High Frequency	300 MHz- 3 G Hz	1m - 10 cm
SHF	Super High Frequency	3 GHz- 30 G Hz	10 cm - 1 cm
EHF	Extremely High Frequency	30 G Hz-300 G Hz	1cm - 1 mm

Figure 3.1: The different frequency bands, has updated from [46]

The low frequencies have a long communication ranges. The reason is that for a fixed distance, the path loss increases with frequency of the signal.

With high frequencies, there is high path loss and this makes that the signal can not propagate further. We can see in the figure 3.1 on the facing page that the low frequency (LF and MF) have the longest communication range.

3.1.2 IEEE 802.15.4 Devices

There are two different types of devices which IEEE 802.15.4 supports them, FFD and RFD. The reason is providing a low cost and more comprehensive network . These devices contain different functionality and consumed different amount of energy.

1) Full Function Device(FFD)

Full Function Device can initialize and manage a network. It can also associate with the other devices in the network. FFD can be used in all network topologies. A FFD can support three operation mode:

- A Personal Area Network (PAN) coordinator, which uses for identifying a network.
- A coordinator who associates with the other devices in the network.
- A simple device which has just the simple functionality for sensing and collecting data.

A FFD can communicate with the all other devices regardless that they are FFD or RFD devices. Any network needs at least one FFD device for coordinating the network. Due to its different functionality and its high power consumption, generally it connects to power. [8]

2) Reduced Function Device(RFD)

A RFD device is operated with minimal implementation ability, only for simple operations. It does not have the need to send large amounts of data and it communicates only with a single FFD at a certain time. It can just send and receive data from other devices in network. A RFD device is battery operated with a small RAM. The most end-point nodes in the network are RFD. They use low energy for only sensing and collect data from an environment and communication with a FFD.

3.1.3 IEEE 802.15.4 Medium Access Control (MAC) Layer

This layer acts such as an interface between the Physical layer and the Network layer. The main feature of this layer is the reducing the probability for data collision.

- Data Transmission

MAC layer uses a LQI function for seeking a free channel for data transmission. The data transmission happens in two ways: beacon mode and non beacon mode.

In the non beacon mode, transceiver only listens to the channel if there is free channel it sends the data otherwise waits a random time slot to send its data.

But in beacon mode transceiver uses super-frame form to data sending. It means that all devices wake up when the super-frame is coming and after, they had received the data they will going to sleep again. In this way, can be saved a lot of energy because the devices must not be in active mode all the time. [28]

Generally, four frame types are found in IEEE 802.15.4, a frame for data tracking, a frame for the security of the received data, a ACK frame which had sent from the receiver after receiving any packet and finally beacon frame for switching a node from sleep mode to listen mode. [13]

The super-frame structure defines with coordinator. Any super-frame bounds with two beacons and the time between them is divided into 16 time slots.

The super-frame consists of two parts, a active and a inactive part. The active parts divides into two parts: a Contention Access Period (CAP) and a Contention Free Period (CFP). For more information about super-frame see [15].

The main layers in International Standards Organization (ISO) has shown in the figure 3.2 on the next page.

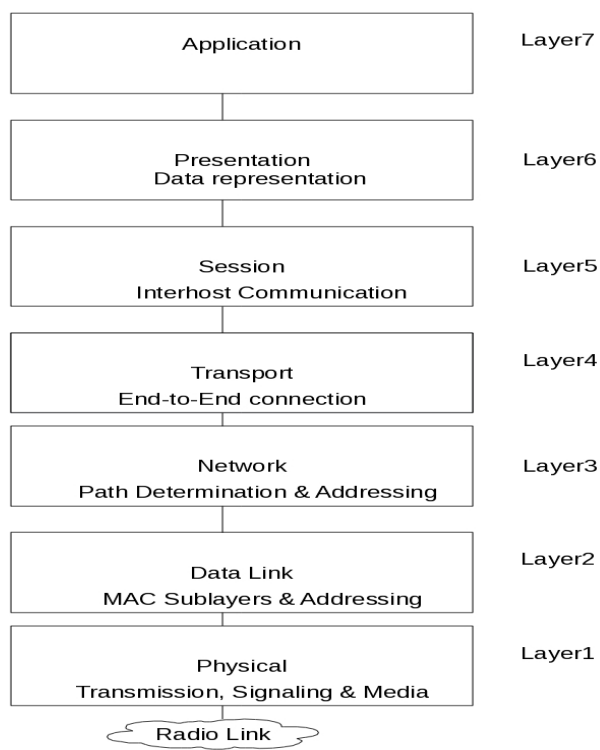

Figure 3.2: The 7-Layers of OSI Communication, has updated from [32]

3.2 ZigBee

Different wireless protocols are targeted to different applications. There are many requirements due to power consumption, communication algorithms, systems cost and etc.

The most typical representative of WPAN, that confirms most requirements to low power applications, is ZigBee standard, which is developed by ZigBee Alliance. [3]

ZigBee is latest wireless communication technology widely had used in wireless sensor network. It is a promising standard with high potential to further development. ZigBee was created for the first time in 2004. The name ZigBee is said to come from the domestic honeybee, which uses a zigzag type of dance to communicate with the other hive members. The most devices based on ZigBee are battery operated devices therefore energy conservation is one of the restricting which have taken a lot of attention lately. [27]

In the figure 3.3 on the facing page have compared ZigBee with the two other wireless communication technologies, Bluetooth and WiFi. The energy consumption and communication range for each technology are considered. ZigBee uses relatively low data rate for a communication range between 10-70 m. It supports many nodes theoretically 65000 and consumed very low power.

The requirement for long battery lifetime, low data rate and less complexity were the main reasons of ZigBee existence. Opposite of the previous standards which provide higher data rate at the expense of power consumption, ZigBee will meet the requirements for stability, security, low power and low cost systems.

ZigBee has assumed to be one of the global network standards. It has been designed to provide the following features:

- Low power consumption.
- Low cost in device, installation, network maintenance.
- High density of nodes per network.
- Simple communication protocols, global implementation.
- Support for large networks, theoretically up to 65 thousand devices. [16]

	ZigBee	Blue-tooth	WiFi
Standard	IEEE 802.15.4	IEEE 802.15.1	IEEE 802.11 a,b,g,n
Topology	Mesh, Star, Tree	Star	Star
Frequency	868, 915 MHz 2.4 GHz	2.4 GHz	2.4 GHz 5.8GHz
Data Rate	250 K bps	723 K bps	11-105 M bps
Node	65000	8	32
Range	10-70 m	10m	10-100 m
Energy Consumption	Very Low	Low	High

Figure 3.3: ZigBee, Bluetooth and WiFi, has updated from [46]

The ZigBee standard is based on the first two layers of the IEEE 802.15.4 standard and its RF power specification comes from IEEE 802.15.4. The IEEE 802.15.4 defines 1mW as a minimum power. [47],[2]

ZigBee defines the network, security and application framework profile layers for a system built on IEEE 802.15.4 standard. In this way can performance of the IEEE standard will meet the requirements for low complexity and low power. The figure 3.4 shows the different layers of ZigBee and IEEE 802.15.4 standard.

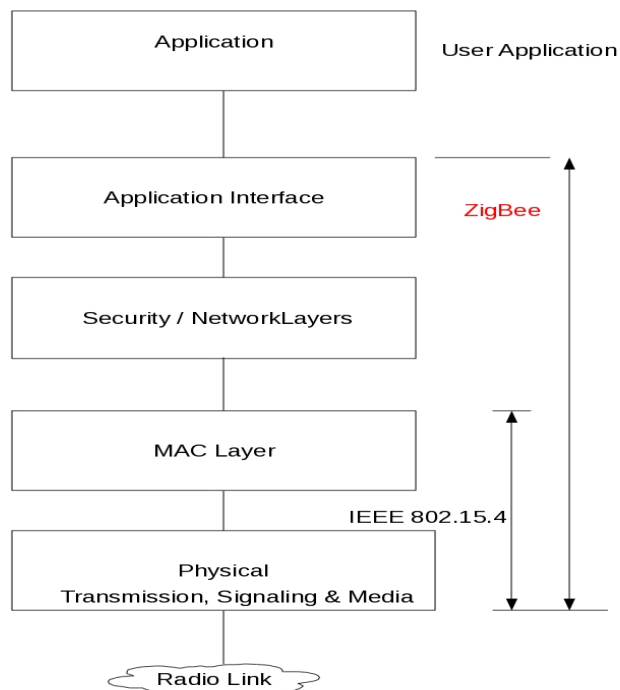

Figure 3.4: The Communication Model Adapted to a ZigBee Stack, has updated from [32]

3.2.1 Advantages Of ZigBee

The some of the advantages of ZigBee are:

- Easy Installation

A advantage of ZigBee protocol is easy network installation which is desirable for home usages. The network capability for more expansion makes that a ZigBee network can discover a large geographical area.

Theoretically ZigBee networks can consist up to 64 thousand (65,536) nodes. But the current networking has not reached until now to this level. [27],[24]

- Low Power Consumption

One of the ultimate goals of ZigBee is to provide low power consumption solutions. The ZigBee devices have promised to use very low energy and they can run for years on inexpensive batteries, e.g. a door which uses a ZigBee node for opening and closing can run for up to five years on a single double-A (AA) battery. This makes ZigBee more capable for wireless sensor network.

A wireless sensor network uses around sub-milli-ampere for signal transmission which allows a 3-volt DC battery run up to many years, but the lifetime of battery depends on the amount of transmitted data namely data rate. [7],[31]

The reason of ZigBee's low power consumption is not its low energy consumption in RF, but the switching transceiver to the different radio states make saving a high amount of energy.

The most ZigBee devices are designed to switch automatically their radio to sleep mode when there is not any data to transmission. Their transceivers will remain asleep until it needs to communicate again. This means that device activation occurs in a low duty cycle which decreases average power consumption. [47]

- Communication Range

The most ZigBee chips are used a low RF power, namely 1mW. They are suited to meet some application requirements such as low cost and simple structure. These products are typically used for home automation and some industrial applications. The communication range for such chips varies from 100 m for indoor to 300 m for outdoor (line of sight). [47]

It is also possible to increase the transmitted power up to 100 mW to achieve a long communication range. These devices with high RF power use

mostly for industrial purposes where there is need for a long range remote control.

In the applications such as detecting of a NBC (nuclear, biological, chemical), ZigBee devices place far apart and to be sure that the system overcome the multi-path and signal fading problems must be the RF power high. With RF power around 100 mW, communication range varies from 300 m for indoor up to 4000 for outdoor (line of sight). [47]

3.2.2 Network Topology

ZigBee supports the Star and Peer- to- Peer network forming. In wireless sensor network nodes create a network by discovering each others presence over the air. A network can easy be formed with sufficient nodes (at least two nodes, one coordinator node and one sensor node for collecting data) within radio range of each other.

Star topology provides for very long battery lifetime operation. Mesh or Peer-to-Peer provides many communication paths. Cluster-Tree topology is combining of Star and Mesh to utilize benefits of both topologies. The following will explain more about these network topologies. [18]

Star Topology (Single-point-to-Multi-point)

The Star topology is the most usual network topology uses widely in applications built for low power consumption e.g. in the personal computer, toys and games.

In Star topology, a node acts such as coordinator for network. The coordinator contains node's ID, sensor values and information about nodes positions, routing and so on. In this topology exist radio links only between PAN coordinator and the end-point nodes.

When a device such as FFD or RFD will join the network, it send request to coordinator node and the coordinator duty is to confirm the request. This node has the main role in the network. It takes over duties like the collecting data from nodes, process data. It also is a interface of the network with the end user or a gateway. The different functionality of coordinator cause that coordinator consumes a high amount energy than the other nodes in the network. [24]

Directly communication between coordinator and the other nodes in the network can occur throughout a single-hop. All nodes in this topology are not

necessarily identical. They can be all FFD nodes but also in the most cases the nodes which is aimed for sensing, are RFD type and just a coordinator node (FFD) can serve data through the whole network.

After a FFD is activated for the first time, it may establish its own network and become the PAN coordinator. The PAN coordinator duty is to find a free channel to communication which is not interfered with the other networks.

With other words, every Star network chooses a PAN identifier, which is not used before by any other network within the radio sphere of influence. This allows each Star network to operate independently. [9]

- Advantages and Disadvantages

A benefit of the Star network topology is its simplicity in functionality. Any node can easily joint to network only with sending a request to coordinator node in the network or in the wired networks with switching to central node. Only a data packet can be exchanged between coordinator and nodes which makes network implementation very simple.

Among network topologies, the Star topology has lowest overall power consumption but the communication range for each node is limited in such form (typically 30 to 100 meters in the ISM band). One other advantage of Star is low communication latency.

Disadvantages of the Star topology are the network's fully dependence to the coordinator node. The coordinator is the only node that can manage and operate network. The coordinator's failure can destroy the entire working.

Some of the critical parameters can consider in this topology are the distance between nodes and coordinator, radio link quality and the environment conditions (indoor or outer door with many obstacles between nodes).

The long distance between nodes makes communication more difficult and increases the probability for error. The received signal strength can vary with the environment conditions, it can be weakened with factor between 4-6 in various areas. If node lies long from coordinator node that there is more chance to low radio quality link and signal fading. These arguments may limit the discovery area of the network. [28],[7]

The Peer-to-Peer Topology (Multi-point-to-Multi-point)

The Peer-to-Peer network topology is one of the most used network topology. In this topology, the influence of a central node is reduced. For the commu-

nication in the Peer-to-Peer topology is not need for any connection with a coordinator node. It means that each node can directly communicate with the other nodes in its radio range. This topology operates in ad hoc fashion and allows data transferring with multiple hops from any node to the other node.

The network flexibility is one of the benefits of this type topology but it suffers of complexity for providing connectivity between all nodes in the network. Such complexity can be economic costly in network expansion and maintenance. [8]

The Mesh topology can be referred as a version of to Peer-to-Peer topology due to its data transmission manner.

Mesh has highest overall power consumption among the network topologies but it is highly fault tolerant. In the Mesh data pass from one node to its nearest neighbor node. Mesh network topology is commonly used for a large scale wireless sensor network.

- Advantages and Disadvantages

One advantage of Mesh topology is highly fault tolerant. It means that some of the nodes can be selected such as leader nodes and these nodes have designed for special functions. With any failure of leader, can another node take over the responsibility that the previous node had. This creates more reliability for network.

The self configuration has made Mesh topology more efficient network form for wireless sensor network where there is high probability for node failure anytime.

In opposite of Star, Mesh topology can expanded for a large geographical area. It can be included many nodes in this topology and it makes Mesh topology very suitable for large dense networks.

The data routing algorithm is one the most important challenges in such topology. A robust routing protocol needs in such form for providing the network scalability.

Applications such as industrial control and monitoring, surveillance systems, asset and inventory tracking would be mentioned for a Mesh network topology. [9]

There are also other combinations of different network topologies to fulfill some requirements that the system must to serve them. For example, hybrid network topology is a Star-Mesh topology. In this form the simplicity and

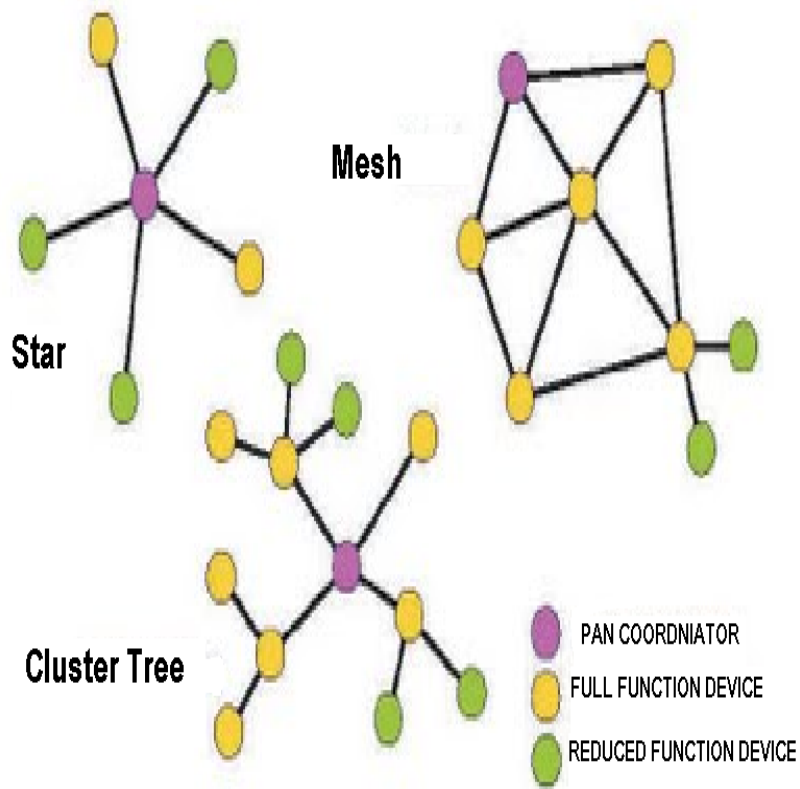

Figure 3.5: Different network topologies which have supported with ZigBee [9]

low power of Star topology is considered and the long communication range and self healing properties of Mesh form had emphasised. [19]

3.3 Zigbee Standard Overview

The Zigbee standard is suited for the family of low-rate wireless personal area networks (LR-WPANs), allowing network creation, management, and data transmission over a wireless channel with the highest possible energy saving.

3.3.1 ZigBee Devices

To provide a low cost implementation, ZigBee standard consists of three different type nodes: (1) ZigBee end device, (2) ZigBee router, and (3) ZigBee coordinator. They are corresponding to end, coordinator and PAN coordinator devices in the IEEE 802.15.4.

- ZigBee Device (ZD)

A ZigBee Device, can connect/disconnect of network, collect data from the environment, insert sensory data into packets, and send them to destination nodes. They can be RFD or FFD devices. [28]

- ZigBee Router (ZR)

A ZigBee router allows the other devices can connect/disconnect of the network. If a router accepts a request from the MAC layer according to adding a new device to the network, it provides the connection of the new device to the network.

A ZigBee router also assigns an address to the new joined devices and updates the current routing table of all nodes in network. In addition, it contains all information required for routing of data. For example, the destination node, optimal routers and so on. Due to its several functionality for data transferring such device must be a FFD.

- ZigBee Coordinator (ZC)

The only difference between a ZigBee coordinator and a ZigBee router is that the ZigBee coordinator is also able to set up the network. One ZC which is not used already can initial the network. The ZC and ZR support all the requirements by the ZigBee standard in order to set up and maintain communications. In the Star, Mesh and Cluster-Tree network topologies the selection of ZC such as the sink node is a naturally choice. [28]

ZigBee uses the Direct Sequencing Spread Spectrum (DSSS) technique for sending a signal. DSSS increases the signal frequency, making signal power high in the noisy network. The 2.4 GHz band uses Orthogonal Quadrature Phase Shift Keying (OQPSK) modulation where other frequency bands use the Binary Phase Shift Keying (BPSK) modulation. The ZigBee receiver sensitivity varies from -85 dB m to -92 dB m in respect to 868/915 MHz bands and 2.4 GHz. [4]

There are three types of data transmission methods between ZigBee devices: from coordinator to a device, from device to coordinator or between devices. Since ZigBee based on the IEEE 802.15.4 standard, the data flowing occurs in the non-beacon and beacon mode.

In the Peer-to-Peer networking each device can exchange data with the others in two ways: first by periodic listening and sending data and second sending data at certain time for saving power.

In the figure 6.2 on page 76, the different communication technologies has compare to ZigBee protocol. We see that the cost of ZigBee is the same for Bluetooth and communication range is between 10 m - 100 m. The data rate for ZigBee is lower than the others.

3.4 ZigBee Applications

The ZigBee applications include:

- Home Control:

In the home applications, the sensor nodes based on ZigBee can be used for monitoring of objects movements in the house or for measuring climate conditions. Also the nodes can integrate in the smart lighting systems and game toys.

- Commercial buildings:

Energy monitoring, Heating and ventilation, Lighting, Access control.

Communication Technologies

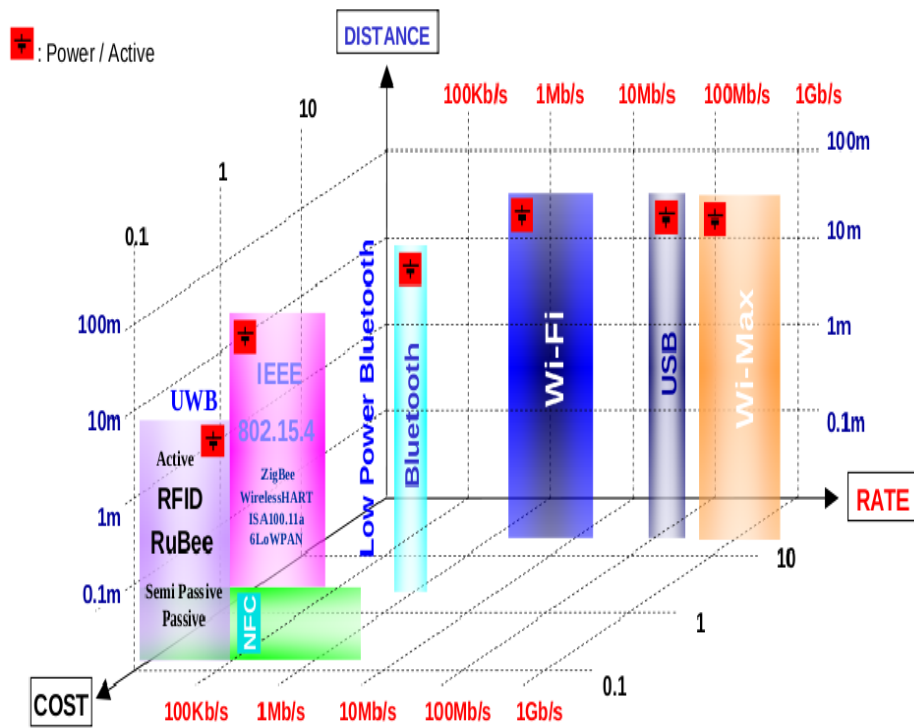

Figure 3.6: ZigBee and communication technologies [46].

-
- Industrial:

Process control, Environment management.

- Military Field:

Zigbee sensors can track the enemy tanks and observe some movements of enemy.

- Medicine Field:

Sensors utilizing Zigbee are used for monitoring the heartbeat, blood pressure and the percentage of the cholesterol in the blood. [4],[16]

3.5 Some previously ZigBee simulations

In [12], has designed three models for the three frequency bands. The goal is to compute BER of the received signal versus signal to noise ratio (SNR) for different bands that use different modulation, namely QPSK for 2.4 GHz and BPSK for 868/915 MHz. Mat Lab has used for simulation and results show that with the higher data rate, there is more chance to error.

In [13], had shown the total energy dissipation in the Cluster-Tree and Mesh topologies. The simulation results show that in the Cluster-Tree network topology, energy consumption is considerably lesser than the simple ZigBee Mesh topology. Also it has shown that the total number of nodes that are left after a certain number of transmission in the Mesh network are far lesser than the Cluster-Tree topology. Hence, the longevity of a network is increased using Cluster-Tree form.

3.6 Zigbee Routing Layer

For a packet transmitting, a node needs all information about routing, e.g. destination node, possible routes, the best route and so on. Generally routing algorithm can be classified into two mechanisms:

1. Distance Vector Routing: distance means how far and vector means in which direction. Here any node informs the other nodes in its neighborhood of its position and routing information. The routing information travels just between neighbor nodes.

2.Link state Routing: in this algorithm, each node has a routing table of network and calculates the best route from itself to another node in network. Nodes have information about the whole net and the connected nodes to network.

- Ad On Demand Distance Vector(AODV)

This algorithm has used mainly in ZigBee protocol. AODV is a reactive routing algorithm. This means that it broadcasts packets just when it is necessary. With other words, it establishes a route to a destination node only on demand. One of the main features of this algorithm is high node's battery lifetime. AODV will have high latency for establishing the first route between nodes.

In AODV protocol, communication establishes only when a node has data to send. So it sends a request to all nodes in the network and the nodes will send this further inquiry. There is just one route in routing table and it contains address for destination and the next hop on the way to destination. [28]

The advantage of AODV is that it creates no extra traffic for communication along existing links. Also, it requires small memory. But AODV requires more time to establish the first connection.

3.7 Chapter Summary

Different network formats have their advantages and disadvantages. Finding the best and optimal format for specific applications is a critical factor for network designers. In this chapter, ZigBee protocol and IEEE 802.15.4 standard have described and some of their characteristic have mentioned.

Low latency, high throughput and high battery lifetime are some desirable issues for a wireless sensor network. But the satisfy the requirements needs a accurate understand for routing protocols, node placement, the number of nodes and not least network topology.

In the figure 3.7 on the next page below had listed some important characteristics of different network topologies.

Topology	Advantages	Disadvantages
Star	Simple implementation Low latency (just one hop) Non switching between different modes, low energy consumption	Sensitive for error Small discovery area
Tree	Large discovery area Simple switching between devices	Sensitive for error High latency High energy consumption
Mesh	Large discovery area High capacity	Very complex High latency High packets overhead (many switching)

Figure 3.7: The advantages and disadvantages of Star, Mesh and Tree topologies, has updated from [28]

Chapter 4

Energy Saving In Wireless Sensor Network

This chapter includes the most common methods for energy saving in different layers of a wireless sensor network's architecture. Sensor networks don't need high bandwidth but their most critical requirements are low latency and low energy consumption at the nodes. The aim of this chapter is to give the reader an overview over different choices for sensor nodes components in the physical layer, different routing algorithms in the network layer. This chapter is divided into two categories:

1. Device Level - Hardware component selection.
2. Network Level - Communication protocols selection.

The lifetime of a wireless sensor network depend on how long the sensor nodes can be hold in life. Changing of batteries for nodes in dense networks is very difficult task. So with the best selection of hardware and software can save a lot of energy in sensor network. [36]

4.1 Energy saving at node

The physical layer is one of the essentials layer of sensor network. It's features are the sense, transmit, received, process data and relay result to MAC layer. In this layer sensor nodes are most critical components.

The sensing unit, transceiver unit, processing unit and power unit are the main parts of a sensor node. In this part, we analyze the different Hardware component selection and how we can choose the most efficient sensor node in term of a low energy consumption.

Communication unit in sensor node is the most energy consuming part. Unlike communication, the computing within individual node uses a low energy. [36]

Electronic's development in the production of electro-devices makes it possible for us to meet different advices in the market. Nodes may be just the transmitter or transceiver (both sender and receiver) or can be used as system-on-chip nodes. Nowadays, many companies have started production and integration of different chips on the devices. It is very usual to integrate many components of systems into a signal chip (SOC). The primary advantages of SOC devices are lower costs, greatly decreased size, and reduced power consumption of the system. Some sensor nodes are listed in the figure 4.1 on the following page.

1) Sensor Unit

The sensor unit senses a physical phenomena and collect information about some events in an environment. It translates physical phenomena to electrical signals. Due to its output, it can be classified as analog or digital sensors. [34]

Selecting a different sensor nodes type requires knowledge of the application which system be aimed for it, some examples of different types of sensors :

- Optical sensors: EOF(Electromagnetic time-of-flight) is named RADAR (Radio Detection and Ranging)
- Temperature sensors: Thermometers, Thermistors
- Heat sensors: calorimeter, bolometer.
- Pressure sensors: altimeter, barometer.
- Sound sensors: seismometers, microphones.

Due to the physical parameter type, a sensor node can consumed different amount of energy. For example the pressure sensor uses 10-15 m W and temperature sensor uses 0.5-5 m W. [36]

Chip	Frequency	Data Rate	Device Type	Voltage	TX Power (dBm)	Current Consumption (RX)(mA)	Wakeup Time (PD->RX/TX) (uS)
CC2400	2400-2480 MHz	1170 Kbps	Transceiver	1.6-2 V	0	24	1170
CC2420	2400-2483.5 MHz	250 Kbps	Transceiver	2.1-3.6 V	-25 to 0	19.7	
CC2430	2400-2483.5 MHz	250 Kbps	System-on-Chip	2-3.6 V	0	27	645
CC2431	2400-2483.5 MHz	250 Kbps	System-on-Chip	2-3.6 V	0	27	645
CC2500	2400-2483 MHz	500 Kbps	Transceiver	1.8-3.6 V	0	12.8	240
CC2520	2394-2507 MHz	250 Kbps	Transceiver	1.8-3.8 V	4	18.5	500
CC2531	2394-2507 MHz	250 Kbps	System-on-Chip	2-3.6 V	4.5	20.5 (lowest)	600
CC2550	2400-2483 MHz	500 Kbps	Transmitter	1.8-3.6 V	12.8		240

Figure 4.1: Some selected nodes form Texas Instruments Company and their proprieties

2) Transceiver Unit

The transceiver unit should support the 802.15.4 standard. It gathers data from an environment and shares the collected information with the other sensor nodes in the network.

The radio transmission and reception occurs in the transceiver unit, this part has the great impact over node energy consumption. Energy can be saved by going to sleep mode when there is no need for data transmission.

There are some key criteria for selection of a transceiver :

- Power consumption requirements
- Throughput
- Current consumption in the different radio modes
- The communication range

Different chips from Texas Instruments can be some alternatives for transceiver selection, for example CC2420, CC2430.

3) Processing Unit

The computation occurs in the processing part. A micro-controller reads data, defines communication protocol and makes data ready to transferring. The power consumption of a processor depends on how long node expands time in its different radio mode. [36]

The different micro-controller are aimed for different applications but it seems that the MSP430 micro-controller can be one of the most best choices. The MSP430 microprocessor provides from TI (Texas Instruments). It is a ultimate solution for a wide range of low power applications within wireless sensor network. The applications such as monitoring, asset tracking, building automation, remote controls, gaming, toys and home electronics. [37]

Some characteristics of MSP430 is summarized in the table 4.1 on the next page.

4) Power Unit

Current consumption in waiting mode	0.8 uA
Current consumption in idle mode	0.0013 mA
Current consumption range	0.1 - 400 uA
Voltage	1.8 - 3.6 V

Table 4.1: MSP430 properties [36]

The sensor nodes are designed to run AA batteries. There are many different batteries in the market and the selection of battery must be attentive to the system applications. The duty cycle (the length of active mode) has an impact on the energy consumption and the battery lifetime. In most cases, a high duty cycle can reduce battery lifetime.

4.2 Energy saving at MAC layer

Generally, the MAC layer is responsible for coordination between nodes in a network. A large part of the node's energy is used for radio signal sending and listen to the communication channel for receiving a signal.

In a wireless sensor network, nodes communicate with each other within a wireless channel. When at least two sensor nodes attempt to access the communication channel at the same time, data collision occurs. As a result data collision has an effect on the network lifetime of a sensor network. The collided packets must be retransmitted and this wastes energy.

The most important responsibility for the MAC layer is to provide a free channel for communication and avoid data collision.

4.2.1 Time Division Multiple Access (TDMA) protocol

TDMA is a channel access method. This protocol allows several users to share the same frequency channel (medium) at different times by dividing the communication time into several frames or slots.

All nodes can talk with each other while the coordinator of network initiates the network operations. TDMA is more suitable for one hop communication. In multi-hop communication it will be difficult to manage all the slots for nodes. But idle listening can be avoided by using TDMA protocol and this can decrease the energy consumption in the network. [36],[38]

4.2.2 Sensor MAC (S-MAC)

This protocol uses three transceiver modes to reduce energy consumption of network. S-MAC allows nodes to transmit, receive and sleep periodically with a low duty cycle. The energy consumption of node is proportional of the activity time. A low duty cycle has a low energy consumption.

A node with low duty cycle can sleep the most of time and it can decrease the amount of energy consumption. In this protocol all nodes have the same synchronized and periodic listen and sleep cycle. [35]

When two nodes will to talk with each other, a node send a RTS (Request To Send) and after that RTS be accepted from other node, send back a CTS (Clear To Send) to the originally node. In this way they can be informed about their modes. S-MAC implements information of neighbors nodes called Network Allocation Vector (NAV) before any RST sending to avoid of any collision. This protocol is best suited to low traffic networks. [36],[38]

Some of the main features of this protocol are :

- Periodic active and sleep radio modes
- Collision avoidance
- Low duty cycle
- Low Over-heading

4.3 Energy saving at Network Layer

The previous section was about sensor nodes elements, data collision in a wireless channel.

The selection of optimal data routing and communication protocol which costs a low energy consumption for a network is the main feature of network layer in a wireless sensor network architecture. Some of the data routing have included in this part.

- Direct

In direct routing, the data send directly to base station. If the base station lies long away from the node, the traveling of data is consumed a lot of energy but in the cases with short distance between nodes and base station, this routing algorithm can be desirable one.[36]

- Multi-hop

In the most cases, data send in a multi-hop version. It means some nodes in the network act such as intermediate nodes. Each node can collect data from environment and transmit data to neighnoring nodes. The router nodes are responsible for routing and disseminating data. The existence of many router nodes increases the number of short hops in the network. It is clear that the power consumed by using N short hops is N times smaller than the power consumed in a long hop. [36]

4.3.1 Communication protocols for wireless sensor networks

- LEACH (Low Energy Adaptation Clustering Hierarchy)

The LEACH is a routing protocol similar to clustering protocol where a network consists of many clusters. In such protocol, one node acts such as cluster head (local base station). Nodes with high level power are mainly selected to be cluster heads (BS). All nodes in the local area send their data to the local BS and from the local BS's data will transfer to the main BS. The high level power is the only requirement of being a BS. After selection of a local BS, the BS sends its information to the all nodes in the network. The nodes will decide that which local BS they will to join corresponding to minimum energy consumption in communication.

The cluster head sends message to the nodes in its local area to turn on their radio at certain time. Otherwise, the node's radio will turn off when there is not any activity in the network for saving the energy. This protocol provides short distance transmission between nodes in a network. [36]

- PEGASIS (Power Efficient Gathering in Sensor Information System)

This routing protocol is an improvement over LEACH protocol. But the selection of cluster heads in this protocol is different than LEACH. Here the selection occurs randomly between nodes in the network. This causes a randomly death of nodes.

PEGASIS is a chain based protocol with the cluster head as the first element in the chain. In the table 4.3.1 on the facing page has listed some routing protocols and network's lifetime. [36]

Algorithm	Network lifetime
Direct	45.90%
LEACH	46.07%
PEGASIS	43.76%

Table 4.2: Lifetime comparison of network for different routing algorithms [36]

4.4 Summary

Designing of a low power network includes many factors. These factors varies from selection of sensor nodes, correctly data transmission and receiving, signal processing at nodes to communication protocols. The communication protocols have significant impact on the overall energy dissipation of the network. An overview of data routing in the network layer of wireless sensor network architecture has described in this chapter. The LEACH data routing protocol has included. We have also mentioned the different units of a sensor node and their duties.

Chapter 5

Wireless Sensor Network In Greenhouse

The use of tiny elements for monitoring an environment and control some physical phenomena has taken hold in our daily lives and their inevitably impact has made our lives more comfortable.

Agriculture has come to be just one of the wide range application areas which has been offered wireless sensor network. In the last years the greenhouse system has greatly developed. The use of different sensor nodes for measuring the various physical parameters such as temperature, light, humidity and etc in greenhouses has become more common nowadays.

The fast and good development of sensor network technology, offers many simple and cheap services which were very complicated and expensive many years ago.

The remote control and monitoring of greenhouse's condition gives possibilities for the owner to monitor many greenhouses continuously. The replacement of wireless sensor nodes instead of wired sensors has caused a decrease in greenhouse monitoring system's cost and complexity.

In this chapter, a sensor network with few sensor nodes is used to monitor the greenhouse climate. We have used sensor network technology in agriculture in order to observe some environmental parameters such as temperature. The measuring temperature and collecting observed data are the main tasks in this part. The sensor nodes have located in different places and they will measure temperature at a certain time and send data to a PAN node which is located near the ceiling. This node can communicate with the all nodes and a remote center via a gateway node.

The parameters such as node position, the amount of data and not least the network topology will be described here.

5.1 Effects of wireless sensor network technology in Agriculture

The current agricultural industry needs technology modernization because of its demands of high production, high production quality and market needs.

To meet these requirements the control and monitoring systems play an inevitable role. The use of control and intelligence systems such as wireless sensor networks have established in the most of levels from production to product delivery.

For example, throughout a WSN, the conditions of greenhouses can be monitored continuously and the level of the environment variables such as temperature, light, humidity and carbon dioxide can rapport to the owner. It can help the owners to a better understanding of how plants grow and how each factor affects the plants growing. Consequently, they can be able to manage plants productiveness.

Also, a monitor and control system can be used in greenhouses in northern countries for the decreasing of energy consumption, especially during the winter. This system can turn down the heating if it is a sunny day and turn up the temperature at night. In this way, systems can require low energy for heating. [26]

In the conventional greenhouses, it was enough to install a sensor element to measure some parameters but this no longer satisfies the requirements for large and modern current greenhouse systems.

The large size of the current modern greenhouse is one of the reasons for having more than one measurement. In such systems, several measurements are needed to do the control and monitoring in a secure way. Nowadays, many sensor nodes are included for monitoring greenhouses, to offer accurate data to the owners or remote control centers.

The required information can be collected with distributed sensor nodes through a large geographical area. The position and communication range for each sensor node are some of the most important factors in design of the network. A very spread network can collect data from every place and it can cause more accuracy. This increasing of the number of nodes can lead to an

increase also in the cost of system, which must be considered.

5.1.1 Advantages of WSN in greenhouse

In the latest, wireless sensor network has perceived one of the best solutions for control and monitoring of greenhouses in term of easy installation, low cost and reliability. The relocation of some nodes in the network can occur very easy and this creates more system's flexibility for different network's format.

WSN maintenance is also cheap and easy. The only additional cost needed is when sensor nodes batteries die, so the batteries must to be charged or replaced. But if it uses an efficient power saving algorithm, can lifetime of battery expand over many years.

The other impact of wireless sensor network in greenhouse is to monitor and observe the conditions of greenhouse continuously. For the owners of the greenhouse it is important to know how greenhouse conditions vary the whole time. They need to be informed about the changes in temperature, humidity or light. These parameters have direct impacts over plant growth performance so they must take place in a desirable way to meet production requirements.

Through the sensor elements, environmental parameters can be measured and then via radio links, data can be sent to a central (base station) for further processing. A base station has the responsibility to control the conditions of network and can order the actuator to do some jobs. Eventually, the processed data can send to the user. Then the owners can always have access to observed data which gives them ability to be aware about the house conditions anytime.

Plant growth

Plant growth is dependent on ambient climate and the amount of fertilizer, lighth and water they get. With the appropriate combination of these, production can be increased to some degree. In order to have control over these factors, a greenhouses perhaps best alternative is where it can be provided with many methods for having high production quality.

Monitoring of greenhouse is essential to create an environment where low cost can be combined with increased efficiency of plants growth. To verifying

this, the parameters such as temperature, humidity, intensity of illumination play an important role in the greenhouse production quality.

The keeping and controlling these parameters at a desirable level to provide most plant's growing has great importance in production process. The ventilation and heating can be used to modify indoor temperature and humidity conditions in a greenhouse. In our work the focus is on the temperature measurement inside the house.

For the owner of greenhouse, the measurement of the humidity is also important. Humidity affects the plants growth and it changes with temperature. There must be a balance between temperature and humidity. If there is too much moisture, it can produce plant diseases and when there is less moisture plants can dry up. But the measurement of the moisture is out of our vision and we concentrate only on the measurement of temperature.

5.2 Literature overview

In this section, we describe some of previous works and have shown some of scenario models in below figures.

Andrzej et al.[15], proposed architecture for ZigBee-based Mesh network form with event-based control technique to solving the climate control problem for greenhouse. They found that the event-based control reduced the number of changes and more suitable for saving energy in sensor nodes compare to the traditional time-based systems.

A special characteristic of event-based system is that it based on detecting an event of interest when it is coming to happen. Generally, these systems spent less energy and they have longer lifetime.

When an event happens, a new signal generates within the nodes and it is sent to the base station for further processing. In this way, nodes don't need to be active the whole time. They can be woken up to sense and go to sleep when they are finished with their jobs.

The actuator nodes can control the system performance and offer the system requirements, for instance, they can turn off ventilation if it is necessary due to changes in outside weather conditions. The goal of the system is to meet real-time data for a monitoring network. A scenario model has shown in the figure 5.1 on the next page.

In the Sidek's et al [50], work formed a system based on radio technology. The goal was to measure environmental parameters such as oxygen and

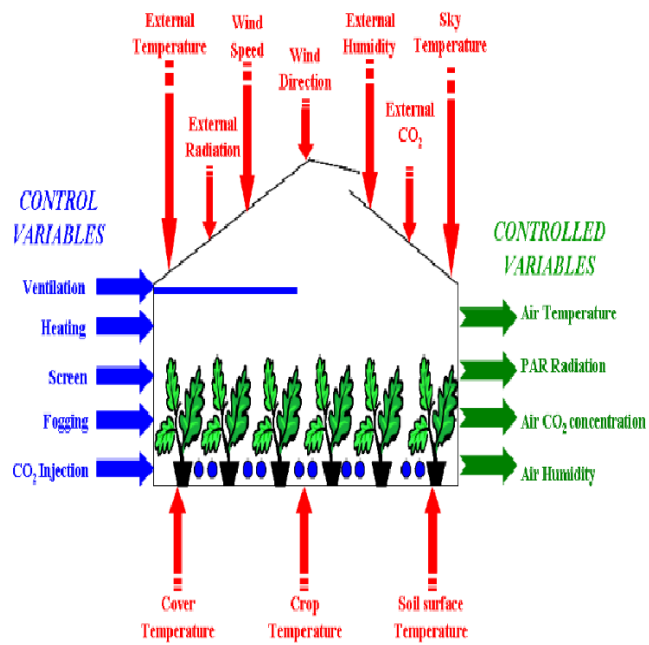

Figure 5.1: A greenhouse model [15]

carbon dioxide with sensor nodes which had distributed in the area. The measured data can be sent to a remote place e.g. a computer or mobile phone for further use.

Testing took place in the national park nearby Universities Sains Malaysia, and results had shown that such a system can be used for monitoring of greenhouse conditions. In this paper, they have proposed the development of infrastructure for Malaysian rainforest using wireless sensor network.

In [25], the author discusses the impact of sensor node's position on the system's performance. Through this study, the routing method for the sensor network in greenhouse was analyzed. A shadowing model is used for computation of radio loss when the plants grow up.

In his scenario, 13 sensor nodes have installed in different places, namely one part near the land surface, some in the middle of greenhouse and the last part on the top of the greenhouse.

The goal was to provide strategies for designing the effective routing protocol for an agricultural environment such as the greenhouse in the future. For this, three routing methods, DSDV (Destination Sequenced Distance Vector), AODV (Ad hoc On-demand Distance Vector) and DSR (Source Routing) are discussed and average energy consumed (pr Joules) simulated for these routing methods.

DSDV is based on the Bellman-Ford routing. In this protocol, each node has a routing table for data traveling among nodes. The routing information such as destination address, sequence number and next hop is broadcasted to the neighbor node.

AODV routing protocol will be used only when it is a need for delivering data. It makes it possible for a node to be inactive for the most time and be active on the demand. There is small overhead and it uses a small amount of memory.

DSR basically uses an algorithm of Source Routing. A route adds when it is discovered any path for data transferring. DSR keeps the route cache instead of route table.

The results have shown that DSR has the lower energy consumed compared to the others methods.

In this work [20], Liu has analyzed a system performance where they had used sensor nodes for monitoring the temperature, humidity and soil moisture in greenhouse. The sensors from Crossbow Company have read parameters every 5 minutes and route the observed data to sink node where data can be storage or sent to a remote center. They were programmed to be in a sleep

state while there is not any sensing or communicating.

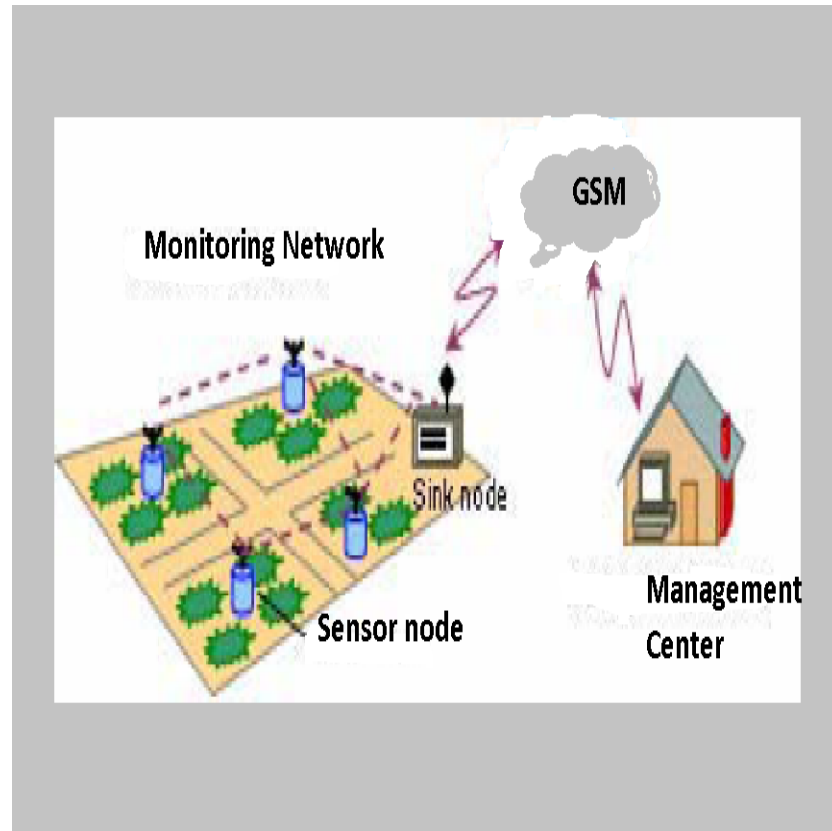

Figure 5.2: A greenhouse model [20]

The system consists of two parts: the first part which gathers data from distributed sensor nodes inside the greenhouse and sends collected data to a management center in farm office. The second part is the software management part on the remote PC.

The SMS(Short Message Service) had used such as communication protocol. Since the agriculture is not a static environment, and signal shares a channel(medium) radio wave propagation can change over time.

In this paper the radio wave loss is examined with RSSI (Received Signal Strength Indicator) and it analyzed via antenna size and distance between nodes in the system. The scenario model has shown in the figure 5.2

The goal of the system which proposed in the paper [21], is to define a control system for greenhouse environment monitoring the crop conditions. The system measures temperature of leaves and humidity on leaves of crops in greenhouse.

The main concern in this paper was to measure moisture on the leaves for avoiding the crops diseases. In addition to greenhouse climate parameters like temperature and humidity, the level of moisture on the leaves is important to have a high production quality. When monitoring of crop conditions and indoor environments can be prevent crops from damages.

In addition, web service has used to give an opportunity for user to access the measured parameters. The scenario model has shown in the figure 5.3

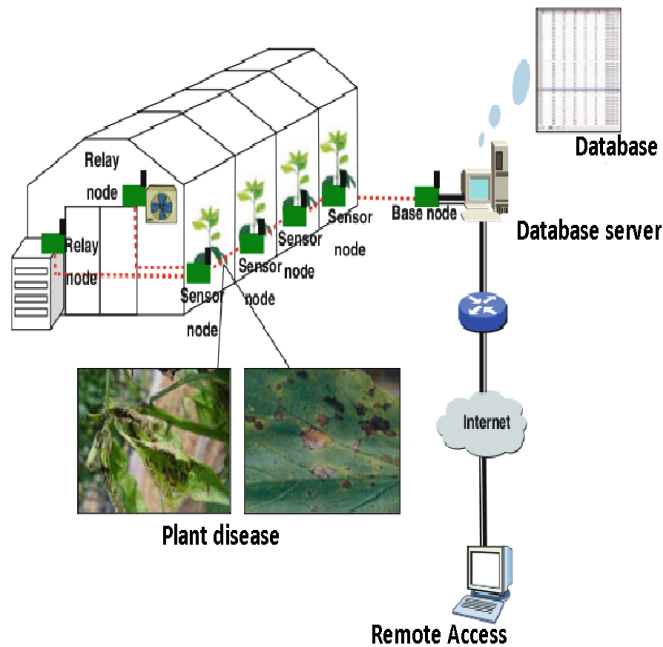

Figure 5.3: A model of greenhouse in the [21]

The system consists of temperature sensor, humidity sensor, leaf temperature sensor, leaf humidity sensor, ZigBee based wireless sensor node, actuator

nodes(heater, ventilator).

Data is being sent to base node for processing or storage, and the base node uses these data to control the conditions and for ordering the actuators.

The 2,400-2,483.5 MHz frequency band, O-QPSK modulation and 250 K bps Data Rate is being used in the system. The sensor node uses a 3.6 V battery and it takes attention into the power consumption of every node in network by adopting low power consumption sensors and chips.

5.3 The challenges in the agriculture

The idea of growing crops or plants in a controlled area has come back to Roman times. Hard work was required to provide good conditions for plants growing and it was difficult to get high production many years ago.

In the latest, computer technology has come in the mirror. Nowadays, with use of heating, cooling, lighting and harvesting management systems it is easier to control conditioning in greenhouses.

Technologies such as sensor network, automation controller, robotics, precision agriculture, have been used enormously. But there are still many challenges that farmers face like maximizing production efficiency, product quality, post-harvest operations etc. [23]

In the agriculture, ZigBee prospect is offering reliable information of monitoring greenhouse conditions. With inexpensive ZigBee based nodes can be monitored soil humidity and start irrigation just when crops need it, in term of saving water. [31]

The spread sensor nodes have the responsibility to gather information from their surroundings and treat this in a desirable way, such that it can be used as accurate and correct real time data. The way that nodes communicate with each other and exchange data is the main focus on our work.

In our case, we used the sensor nodes based on ZigBee protocol in the network with formats like Star, Mesh. Position of nodes, distance between nodes, the sending cycle, radio wave propagation and route data format, are some of the main parameters that will be discussed here. These parameters are a great impact in system energy consumption and as had mentioned before energy consumption is one of the most famous problems in sensor network area.

Our system features are following :

- a) Sensing temperature of greenhouse.

-
- b) Identification of sensing location.
 - c) Data gathering for different network formats namely Star and Mesh.
 - d) Routing data at an optimal way from plants field to base station.
 - e) Defining which network topology is optimal for greenhouse in term of energy consumption.

Our work investigates the power consumption of wireless sensor nodes in the Mesh and Star networks for monitoring of temperature inside greenhouse.

5.4 The goal of simulation

Our job is to compare the proportion of energy used in different network forms. The most interesting expectation is which network topology is best suited for the greenhouse with many nodes spread inside the house.

Node position, distance between nodes and data routing algorithm are the main consideration in our work. We have defined two different data routing for Star and Mesh topologies. Routing algorithm is based on the different radio modes which each node can have. For this, we overlay the most emphasis on sleep and active modes.

The goal is to realize which network form uses the lowest amount of energy and which network format is optimal for greenhouse condition in term of prolonging the system lifetime.

A comparison between multi-hop communication and direct communication will be considered. The power consumed between sensor nodes when they communicate with each other within smaller distances (peer to peer network topology) or when they communicate directly with coordinator node (star network topology) will be calculated.

5.5 Our scenario model

A simple model of the greenhouse has been outlined here to give the reader more of an understanding of the nodes positions. All the nodes are spread inside the house to collect data from any location.

The figure 5.4 on the following page shows the coordinates of sensor nodes. 5 nodes are responsible for measuring the temperature and they are going to send measured data to the sink node which is closest to the roof. After

receiving data in the sink, it will send data to the gateway and through it to a remote center.

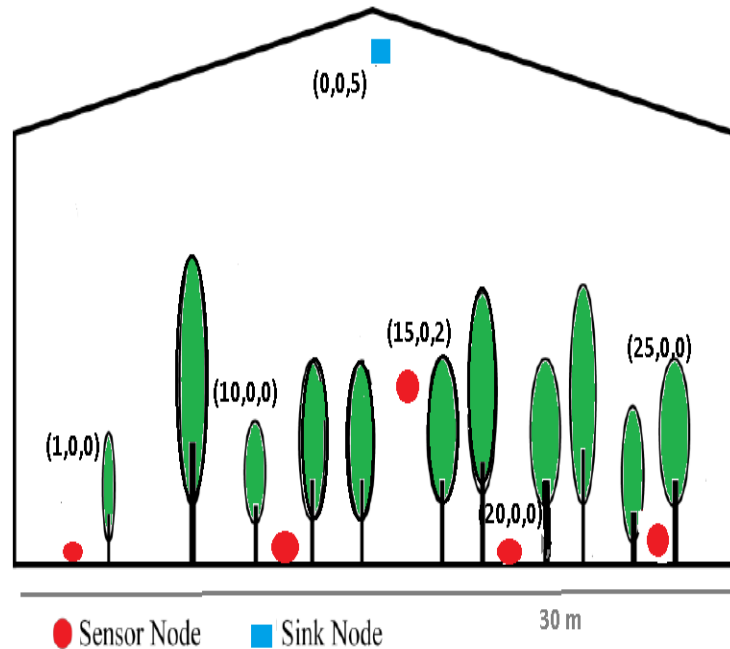

Figure 5.4: A simple model of our scenario.

Some of the nodes are placed between plants and it can cause problems for radio wave propagation and communication between nodes. The path loss, antenna loss and multi-path fading can influence the signal strength. A fading margin (20 dB m) has assumed corresponding to the effects of multi-path fading.

The path loss exponent depends on the simulated environment and is constant throughout the simulations. In our scenario, the path loss exponent has assumed to be 2.5 to include some of the effects of plant growth.

In a greenhouse of $6m \times 30m \times 6m$ we have installed 5 sensor nodes for measuring of temperature inside house and 1 node such PAN node for the

network. The position of nodes are described and shown in the figure 5.4 on the preceding page. PAN has connected to a gateway node. The gateway is always on in term to emergency events.

5.6 Technological model

The nodes in the network measure the temperature and they send data to the sink. The sink has connection with gateway. The gateway can be a node or mobile phone or Internet connection between WSN and remote center. Data is sent to a processing center through the gateway. The user can have access to data in a remote center.

We concentrate on the first layer, namely the physical layer where the sensor nodes measure temperature. Since the nodes are small and they are based on using low-power, the communication between them is important. Here we try to find the best data transference in term of a low energy consumption.

The figure 7.6 on page 95 shows how a packet is sent among the nodes. This data flow diagram is different for Star and Mesh network topologies. But the main consideration is that when a node is ready to send a packet to its neighboring node, it must first check the next nodes radio mode. If the node is in sleep mode, the sending of data must be delayed a random amount of time and sending occurs again. But if the node is in active mode, it means it is ready to accept data, then sending occur immediately.

In the greenhouse, the environmental monitoring can occur in two ways. In the first one, sensor nodes measure the physical phenomena with the constant or rapid cycle and in the second one they measure with the cycle of several tens of minutes.

Some events can occur very fast and the system must plan to detect such events. In an open greenhouse the falling snow, floor or fire can destroy plants. In a closed greenhouse, it could be the water leakage of the pipes. These environmental changing must be reported quickly to a control center. For this, alarm systems have installed in greenhouses. In these systems, observation of conditions occurs within a rapid cycle. If the data reporting to sink occurs rapidly network uses high energy. This scenario is out of our scope.

For monitoring of temperature inside a greenhouse, we must be also consider the condition of outside temperature. The air temperature is high

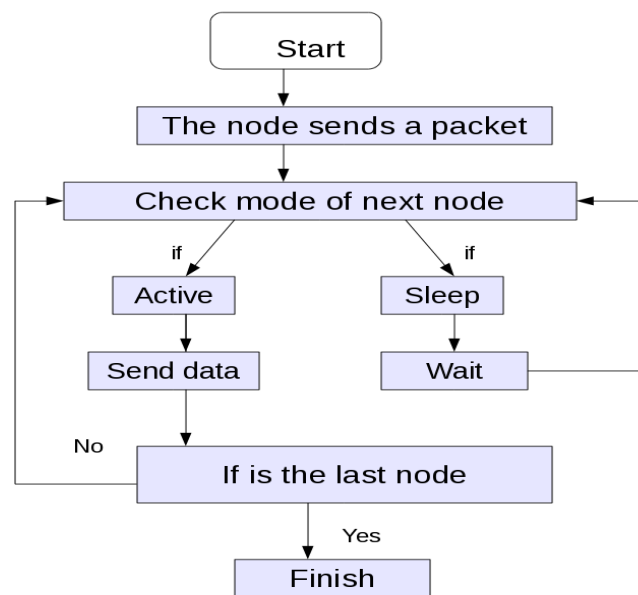

Figure 5.5: The communication between nodes in the network .

during the day and goes down at night. This influences the temperature of inside the greenhouse. But such changing does not occur very fast and the reporting of temperature changing can occur in the cycle of tens of minutes. This scenario we are focused on our work.

Here are two important distinction between daytime and night time, the reason is that plant's growing process is different during the day and night due to temperature difference. For this reason, two temperature set-points are usually considered: diurnal and nocturnal. [15]

During the day, outside weather situation can affect the temperature inside. It means when it is sunny day outside, temperature can rise up and it causes an increasing in the indoor temperature. The temperature can be measured via the sensor nodes and can be sent to the base station and if it is out of the a certain threshold then base station can order the actuator to do something, for example turn on ventilation to cool the room. During the night, if the measured temperature is less than the threshold value, than the base station can be actuator to turn on the heating system to heat up the room.

Accordingly, the sensor nodes that measure such environmental information have low sensing cycles. They can be operated for several months with the existing technology without the external power supply. [25]

Each node can be active for 3.8ms and if in this time it been sent a packet, it can be received otherwise the node is in sleep mode. We had assumed that only one node can be active at certain time to avoid packet collision.

When a packet is sent out it takes time for it to be received on the receiver side. The time that a signal can be detected on the receiver side depends on the distance between the transmitter and receiver. In that time, the signal is in the air and can collide with the other signals.

Probability of packet collision can increase with the number of nodes and packet length. These parameters have great influence on the data lost. We will discuss these in a own chapter.

5.6.1 System Architecture

Our scenario consists of two parts: the first part is where sensor nodes have connected in Star form. The temperature can be measured with nodes and then the acquisition data is sent to a PAN coordinator node which is placed near the ceiling around 5 m higher than the floor.

The second part is where nodes communicate with each other in a multi-hop fashion, namely send to or receive data from neighboring nodes. In this scenario some nodes act as such intermediate nodes. All nodes are chosen as such full function devices (FFD). The reason for this is that they can be able to both sense and route data.

In our case, we had assumed a network which consists of totally 6 nodes. To make it easy we assumed a few nodes, but our scenario is just an illustration of real world.

All nodes have the identical energy consumption and they are Full Function devices(FFD).

The 6 sensor nodes are installed inside the greenhouse and 5 of them measure temperature changes in greenhouse at certain time, (once at 15 minute) and send the acquisition data to a node (PAN coordinator). The all nodes uses battery of 3 V.

There are two alternatives for Star form scenario:

1. Star topology with one PAN coordinator (FFD) and the rest devices RFD.

Since in the Star type, the end nodes only sense and transmit data to the PAN, they can be selected as the RFD to conserve energy. As we know that the RFD uses less energy than the FFD. A FFD contains many functions for serving many purposes; therefore these devices have high energy consumption.

2. Star topology with one PAN coordinator (FFD) and some FFD and RFD devices.

Star topology can be formed with some FFD and RFD nodes also. In our case, we have used the FFD nodes in the network. We will compare the Star and Mesh topology and for this we need just FFD nodes in the network.

5.6.2 Network Hardware

In this part, we will focus on the hardware of the network, namely the sensor node components.

The collected signal from environment processes by the signal processing module in the sensor. Eventually this processed signal sends to the coordinator. For supplying the power, had used a battery. The figure 5.6 on the next page shows a ZigBee sensor node(used chip cc2430) and its main parts.

A sensor nodes are microelectronic devices and they have been equipped by limited power. They have different capacities and aimed for various appli-

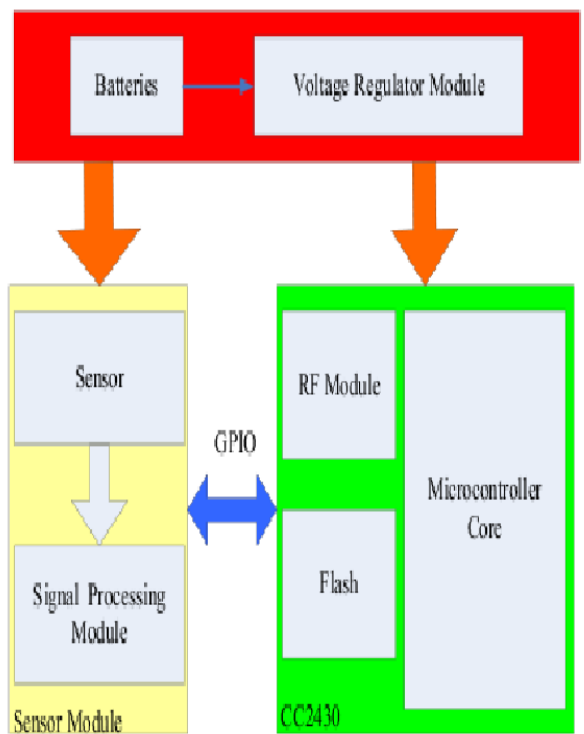

Figure 5.6: The basic units of a sensor node [24]

Chip	Operating temperature Range (°C)	Tx power dB m	Sensivity dB m
CC 2420	-40 to 85	-20 to 0	-95
CC 2430	-40 to 85	0	-92
CC 2431	use in location sensor	0	-92
CC 2531	-40 to 125	4.5	-97

Table 5.1: Different chips from Texas Instrument

cations. Due to their difference, they have different properties, e.g. current consumption in different operations, communication range and cost.

In our scenario we had chosen Chip con 2420 from Texas Instrument and the main reasons for this choice are:

- a)The CC2420 is the industry's first chip which compliant with the IEEE 802.15.4 standard and had used in ZigBee products.
- b) It has low current consumption (RX: 19.7 mA, TX: 17.4 mA) to compare to the other chips from this company.
- c)This chip is more used in literature e.g. in [29],[30].
- d)The receiver sensitivity for cc2420 is -95 dB m. It means that this chip is able to receiver very low signal.

CC2420

The chip cc2420 is based on ZigBee protocol and has low current consumption in different operations. The chip uses 17.4 mA for transmission, 19.7 mA for receive, 396 uA for idle and 80 nA for shutdown state. [30] The high receiver sensitivity makes chip able to detect a low signal strength. It increases communication range.

In this section, some of the properties, advantages and applications of CC2420 will describe.

The CC2420 is used in wireless sensor networks, ZigBee and 2.4 GHz IEEE 802.15.4 systems, PC, home and building automation. It supports much functionality such as packet handling, data buffering, burst transmissions, data encryption, data authentication, clear channel assessment, link quality indication and packet timing information.

The CC2420 with external power amplifier reference design is highly suitable for IEEE 802.15.4/ZigBee™ solutions in need of achieving longer range while still running off batteries. Achieving 580 m with 10 dB m output power and less than 35 mA current consumption makes this design highly attractive. [51]

The CC2420 is a low-cost, highly integrated solution for robust wireless communication in the 2.4 GHz unlicensed ISM band. It complies with worldwide regulations covered by ETSI EN 300 328 and EN 300 440 class 2 (Europe), FCC CFR47 Part 15 (US) and ARIB STD-T66 (Japan). [51]

5.7 Summary

The main consideration in a normal network is the route which goes through the least number of hops. However, the sensor network usually takes the amount of battery as their criterion. The agriculture has just become a typical application field among the wide range of wireless sensor networks applications.

For our scenario, the position of nodes, data routing algorithms, data rate and packet loss are focused on. The impact of these parameters in a wireless sensor network which placed in a greenhouse will analyze.

Some of the benefits to using the wireless sensor network based on ZigBee in greenhouses can be included such: highly productivity, easy installation, no cabling requirement, reliable communication, accurate data and low cost.[23]

Chapter 6

Energy waste in wireless sensor network

A robust wireless sensor network must be able to tackle constantly network's topology changing. When a node dies or moves away from the coverage area, the network form will change. This changing can be critical when there are many nodes which disappear simultaneously making data missing from some places.

The battery emptying can be a main cause for the dynamic network topology in the sensor network. Consequently, conserving power in the nodes can be a start point to having a robust network.

The aim of this chapter is to give the reader an brief overview of the most important factors that cause energy dissipation in MAC layer in wireless sensor network architecture.

Data collision, long idle time, overhearing, over-emitting, transition time and packet overhead are some of the most critical factors in designing a low power wireless sensor network. In this chapter we are analyzed the probability for error and data collision and their impact over network's energy consumption. [34],[35]

6.1 Data Collision

In wireless communication systems, electromagnetic waves share a medium to transferring data. The signal propagation is not well defined in wireless communication channels and obstacles in the transmission medium can degrade

the signal strength. Such media are called unguided medium. The optical communication, radio frequencies and ultrasound could be some alternatives for communication mediums but the radio frequency communication is the most commonly choice for wireless sensor networks.[49]

The signal fading and path loss are the most relevant factors in such systems that affect the signal strength. These factors create uncertainty and inaccuracy for the signal receiving at the receiver. [22]

In the designing of wireless sensor network, the Medium Access Control (MAC) layer is mainly aimed to control packet transmission between nodes in network and also reducing the probability of data collision.

Data collision occurs at the receiver and it can be costly in the term of energy in both receiver and the transmitter, since the data must be resent or received again and it contributes to more energy consumption. The data retransmission leads to a high latency.

Some of the consequences of data collision can be high energy consumption, high delay in data transmission and low throughput of system. Therefore, there is desirable to find some algorithms to avoid it.

Physical reasons

Data collision happens when the MAC layer allows two or more packets can be sent at the same time. If many neighbor nodes want to talk to a node at the same time, they will try to send data when the node starts to listening.

In the wireless network, these packets can collide and interfere each other in a communication channel. The packet collision is one of the common problems in wireless sensor networks.

Data Transmission

Beacon is a synchronization packet which contains information about data pending between nodes. It be sent from coordinator of network in the creating of network at the first time. Data can be sent in the form of a beacon. Each beacon can be occupied by a super-frame, which is divided into 16 slots. The period between to beacons calls inter beacon period.

After sending a packet, the transmitter gets a acknowledgment from receiver to confirm the transmission at a predefined time (t_{ack}). The transmitter waits for such acknowledgment (t_{wait}), which is (t_{wait})>(t_{ack}). If transmitter did not accept any confirmation from receiver, it will start to transmission again.[30]

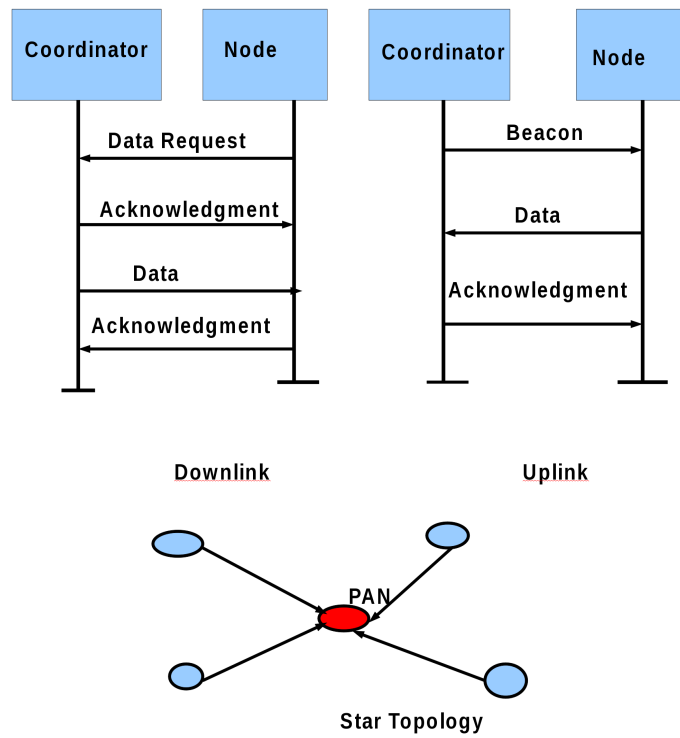

Figure 6.1: Beacon transmission in Star topology, is updated from [30]

6.1.1 The Algorithms For Avoidance Of Data Collision

Traditional MAC protocols such as ALOHA, CSMA and MACA are some based on contention approach. The ALOHA was design for simple packet transmission at the first time in the 1970s. Its mechanism was very simple where a transmitter generates a signal and sends it throughout a channel. A acknowledgment will send back to transmitter after successfully receive. At the failure of transmission, the transmitter will send packet again. But the probability for data collision was very high and it costs for system a high energy consumption.

Therefor, in 1975, Kleinrock and Tobagi developed Carrier Sense Multiple Access (CSMA) protocol aiming for reducing of the data collision. [39]

The standard IEEE 802.15.4 uses a Carrier Sense Multiple Access- Collision Avoidance (CSMA/CA) mechanism to prevent the data collision.

In according to this mechanism, channel must be checked two times before any data transmission. Each checking occurs within randomly time interval. This randomness of time interval decreases probability for data collision.[30]

A Clear Channel Assessment (CCA) checks the channel conditions. After twice checking, if there is a free channel, data transmit. The CSMA/CA algorithm can be occurred just within a described value and if the number of CSMA/CA implementation exceeds this threshold value, will system be informed of channel access failure. [33]

6.1.2 Energy Consumption

In this part, has explained some other factors which cause the energy consumption in MAC layer for a wireless sensor network.

Packet overhead

One of the sources for energy wasting in wireless sensor network is packet overhead. The MAC layer has responsibility for delivering of data to correct destination node. In the dense networks where many sensor nodes have included the MAC layer can make a long packet overhead for transmission data.

This data overhead contains the address of the recipient node, processing, routing, signaling, scheduling and etc. The long packet overhead leads that the transmission of large amount of data consumes more energy.[34]

Overhearing

Although each data packet contains information about the destination and the transmitter node, but in wireless medium signal can heard from other nodes in the neighboring area which are in receiving mode. To avoid such overhearing network consumes energy. For high traffic communications it can be cost a considerably amount of energy.[34]

Long idle time

For calculation of energy consumption in each node in wireless sensor network, we must be able to know how much energy is used in various transceiver states.

A transceiver can be in one of these operational states: sending, receiving, shutdown and idle state.

In the shutdown state, the node is deactivated. In the idle state, the node listens to channel for receiving any messages. In the sending and receiving states data transfers and transceiver is active.

These different states use different energy quantities. Sending and receiving data are costly. Obviously, the shutdown state uses no energy but idle mode mainly uses a low energy portion than transmitt and receiver modes.

One of the important tasks for the MAC layer is to check the channel constantly to eliminate or reduce data Collision as well as possible. Node must sense the channel continuously for getting information about the channel condition. The data transferring occurs when channel discovered as a free channel. The node may wait for a long time for transferring of its data. This waiting time required for data transmission is called idle listening. A long idle listening can be consumed high energy.

When many nodes had included in the network, it can be costly for network to being on listen mode for a long time. In the [49], the author indicates that the idle listening mode can consume 50-100 % of the energy in some cases. The result of this study shows that there is not big difference between energy consumption in the transmitter/ receiver mode and a long idle listening mode.

Over-emitting

The over-emitting occurs when the destination node is not ready to accept any data. Consequently, the packet can not correctly be received.[35]

Transition

The switching between different transceiver modes uses significant energy. For prevent more energy consumption, the number of transitions between sleep and active modes must be limited.[50]

The transition energy is dependent on the time for transition T , the current consumption that node uses in the specific state and voltage of battery V . For example, the transition time between shutdown and idle modes for CC2420 is (1ms). The current consumption in the idle state is 396 uA.

From the below equation, it means (691pJ) transition energy for VDD=1.8 V.[30]

$$T_{transitionEnergy} = T_{transition} \cdot I_{targetstate} \cdot VDD. \quad (6.1)$$

6.2 Analysis Of Data Collision

In this section, we have described the most important factors which influence the probability for error and data collision. The packet length, received power, path loss and the number of nodes in network are some of the parameters which will analyze here.

6.2.1 Packet length and Received Power

The probability of transmission failure is combining of the probability of collision Pr_{col} and the probability of transmission error Pr_e .

$$Pr_{tf} = 1 - (1 - Pr_{col}) \cdot (1 - Pr_e) \quad (6.2)$$

Pr_e is computed as a function of the bit error probability (Pr_{bit}) and the total packet size (L_{packet}) minus the number of bits for synchronization (l) .

$$Pr_e = 1 - (1 - Pr_{bit})^{(L_{packet} - l)} \quad (6.3)$$

But the probability for bit error is dependent on the received power.

$$Pr_{bit} = e^{-P_{Rx}} \quad (6.4)$$

According to the path loss radio propagation model, the ratio between the received power, P_{Rx} , at distance r from the transmitter, to the transmitted power, P_{Tx} , is given by:

$$\frac{P_{Rx}}{P_{Tx}} = C \cdot \frac{1}{r^\alpha} \quad (6.5)$$

where C is a constant that depends on the antenna gains, the wavelength, and the antenna heights, r is the transmission distance, and α is the path loss factor, ranging from 2 (line of sight free space) to 4 (indoor).[52],[30]

If the path loss A is known or can be measured then the received power can be computed from the below equation.

$$P_{Rx} = P_{Tx} - A \quad (6.6)$$

6.2.2 My Case

The goal is to compute the probability for bit error and data collision in the network. All nodes are located on a different places for discovering all the greenhouse space but the minimum distance between them is 10 m.

The three transmit power, -25 dB m, -15 dB m and 0 dB m have included and the received power for these values have computed.

For computing the probability for bit error I consider the transmit power and distance between nodes to achieving received power values.

In my scenario, I assume free space transmission with a path loss factor of 2.5.

6.2.3 Simulation

I have simulated the probability for bit error and the probability for data collision in this part. The MatLab code has attached in appendix A.

The Bit Error Probability

The probability for bit error has simulated for 6 nodes. For calculation, I used the equations from previous section. The distance between nodes is calculated from the receiver sensitivity for cc2420 namely -95 dBm. I must be sure that each node can discover other nodes closer to it. For calculation of minimum distance between nodes, I used the maximum transmit power for cc2420 (0 dBm) and receiver power (-75 dBm) for my scenario.

The chip cc2420 receiver sensitivity is -95 dBm. This value with a fading margin of 20 dBm, can be decreased to -75 dBm (3.16e-11 W) which has used in my simulations.

Transmitt Power (W)	Distance (m)	received Power (uW)
1e-03	10	0.004
1e-03	13	0.002
1e-03	10	0.004
1e-03	13	0.002
1e-03	11	0.003

Table 6.1: The received power and distance between 6 nodes for transmitt power of 0 dBm.

Transmitt Power (W)	Distance (m)	received Power (uW)
3e-05	10	0.145e-03
3e-05	13	0.073e-03
3e-05	10	0.145e-03
3e-05	13	0.067e-03
3e-05	11	0.115e-03

Table 6.2: The received power and distance between 6 nodes for transmit power of -15 dBm.

The result shows that nodes must be placed at least 10 m apart from each other.

The main object here is to comparison different transmitt power with the received power and its impact over the probability for bit error.

Results

Since the received power is very small around $10e-10$, the probability of bit error in my case is 1. I have calculated this value with very big receiver

Transmitt Power (W)	Distance (m)	received Power (uW)
3e-06	10	0.145e-04
3e-06	13	0.073e-04
3e-06	10	0.145e-04
3e-06	13	0.067e-04
3e-06	11	0.115e-04

Table 6.3: The received power and distance between 6 nodes for transmit power of -25 dBm.

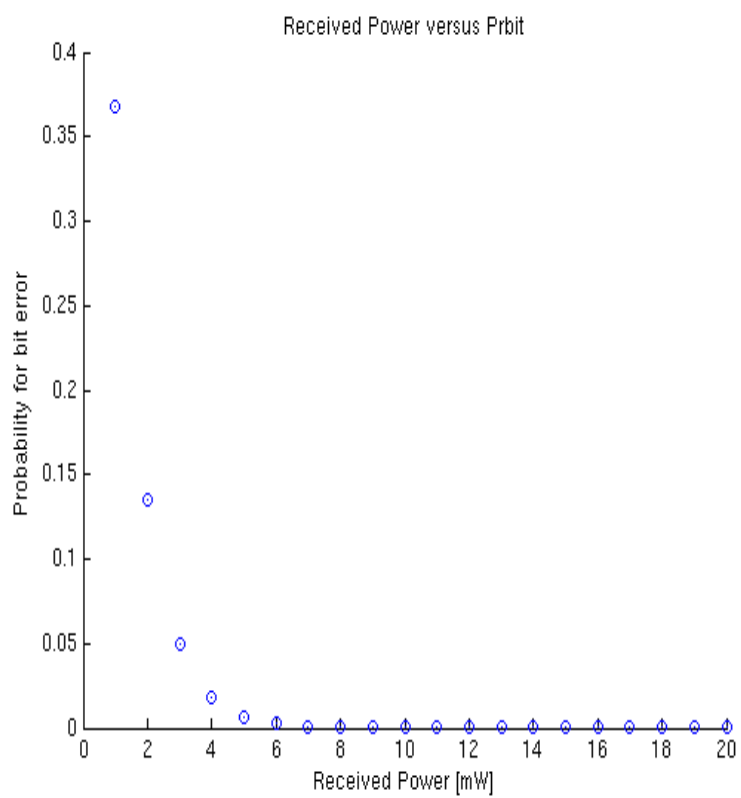

Figure 6.2: The probability for bit error versus the power received

power from 1 to 20 mW. The relationship between the error bit rate and receiver power has shown in the figure 6.2 on the facing page.

In the figure 6.2 on the preceding page can we see that the probability for bit error decreases if the received power increases. It is obvious that with high transmit power signal can detect highly on the recipient side and it decreases probability for bit error. With low probability of bit error system has less chance of error. It makes that the energy of network saves.

The Data Collision Probability

In this section, I have assumed very simple model to calculating of probability for data collision between 5 sensor nodes in my scenario. Obviously, in the dense networks the probability for data collision increases with the number of nodes.

The code creates 5 randomly pulses with only 0 and 1 values corresponding to 5 sensor nodes. After establishment of pulses, the Mat lab function “and” takes two signals from 2 nodes. The output of this function is 1 if there are two 1’s collides with each other. This means for system the packet collision. The number of simulations run is 100.

The main challenge here is to generate a signal and show how a packet collision is changed with variation of packet length and the number of nodes in the network. I have calculated the probability of data collision for different number of nodes 4 and 5.

The code takes the total packet length in bit which contains the 0 and 1 values. Afterward, it generates a signal of M bit of 1 value from the original packet. The signal of 1’s values are indicated such as a packet.

From the tables, has been seen that the probability of data collision increases with the packet size. In the below tables have shown some results of simulation.

When the packet length increases then the probability for data collision increases too.

The probability for data collision increases with the number of nodes.

Total input bits [bit]	Packet Length[bit]	The probability for data collision
30	5	0.13
30	10	0.21
30	15	0.25
30	18	0.27
30	20	0.36
30	25	0.62

Table 6.4: The probability for data collision versus the packet length for 5 nodes

Total input bits [bit]	Packet Length [bit]	The probability for data collision
30	5	0.15
30	10	0.32
30	15	0.45
30	18	0.55
30	20	0.61
30	25	1

Table 6.5: The probability for data collision versus the packet length for 8 nodes

Total input bits [bit]	Packet Length [bit]	The probability for data collision
30	5	0.21
30	10	0.42
30	15	0.47
30	18	0.67
30	20	0.85
30	25	1

Table 6.6: The probability for data collision versus the packet length for 10 nodes

The number of nodes	Packet Length [bit]	The probability for data collision
5	30	0.31
8	30	0.36
10	30	0.42

Table 6.7: The probability for data collision versus the number of nodes.

6.3 Summary

Determining a packet length which minimize the energy consumption in the network at a certain transmit power is the one of the main tasks for designing of a low power network.

In addition, the data collision, overhead, overhearing of data and long idle listening are some sources of energy waste. Their effects over network performance differs according to the specific described applications. The data collision is detected as one of the common problems in the dense wireless networks.

For example, in the networks with high traffic, data collision and data overhead can be more interesting cases for energy waste. Generally, data collision must be avoided as much as possible.

In this chapter, I have analyzed two different concepts. The first one, was computing the probability for transmission failure for each node in term of the received power and the packet size which each node has availability to send it.

The second one, was the probability for data collision versus the packet length and the number of nodes in a wireless sensor network.

The conditions of channel has also great significance over network performance. In the medium with high path loss, the received power reduces and it causes the increasing in the Bit error probability. Consequently, more chance to transmission failure.

I had shown that in a dense network, there is high probability for data collision compared to a network with less sensor nodes. The packet length has a virtual impact over systems for data collision, where the long packet has high probability for interference and collision with the other packets than the short one.

For transferring of a packet through network, the MAC layer adds some bits in front of packet. The number of these extra bits is the same for the

small packets as well as for the long packets. But the long packets has more chance to collide with the other packets in wireless communication. This leads to error and data must retransmit. For the network it means an increasing in the energy consumption.

The high transmit power increases the receiver power which causes a low probability for bit error.

Chapter 7

Simulation

This chapter is about my procedure to resolve the problem. The main goal of this chapter is to show the results of simulation in Mat lab. At the end I will show and analyze results.

7.1 Principle Aspects

The ultimate goal of thesis is the comparison of different network topologies in term of energy consumption. I have analyzed various parameters which has impact on the amount of energy consumption in a network.

I am looking for the optimal network topology for my scenario with relatively low power consumption in each sensor node.

a) Calculating a signal energy consumption

Firstly, I calculate the time that each node used in various radio modes. In other words, how long a node is in transmit/receive or in sleep mode.

b) Calculating power consumption for each node

In this step, I calculate power consumption for each node with respect to its current consumption in different modes. The only challenge is to extract the time spent in various modes. The current consumption for different transceiver modes, transmit, receive and idle can be obtained from the data sheet for chip cc2420.

7.2 Network topology

In wireless sensor networks nodes are placed in an environment for measuring a physical events for a long period. Each node must be planed to manage its energy consumption in order to provide maximum network lifetime. [11]

Star

Due to directly communication between nodes and the PAN node in Star topology, it is the most simple and effective network form for indoor applications of wireless sensor network.

- The transmission range

The transmission range in wireless sensor network is dependent on many factors.

One of the most important factor is transmitted power. A signal with high transmit power travels longer. The relationship between received power and distance varies with an exponent from 2 (free space) to 4. This means that for making double communication range, power must be 4 to 16 times greater.

In other words, for the nodes far from the PAN, the required transmit power must be high which the sent signal can be detected on the receiver side. In the opposite to these nodes, use a low power for data transition in the nodes which lie close to PAN. Therefor, for a Star networking can be designed to use a varied transmit power due to nodes location.

- Receiver sensitivity

The receiver sensitivity is another factor that has great importance for communication range. With more sensitive receiver can be detect very weak signals on the receiving side.

Both transmitted power and receiver sensitivity are measured in dBm. Typical receiver sensitivities are between -85 and -110 dBm. (The dB scale is a logarithmic scale 0 dBm represents 1 milliwatt, so 1 watt is 30 dBm.)

The transmitted power at 0 dBm and a receiver sensitivity of -85 dBm will result in an outdoor free space range of 25-50 meters communication range, while a sensitivity of -110 dBm will result in a range of 100 to 200 meters.

With using of a receiver sensitivity with -100 dBm instead of a radio with -85 dBm can reduce the transmission power by a factor of 30 and achieve the same range. [11]

Although the chip cc2420 uses very low power for transmission, it has a receiver sensitivity of -95 dBm which makes the chip to be able to detect the very weak signals. According to this receiver sensitivity, receivers can detect signals with $(e - 13)$ strength.

- Antenna

The other factors that can affect the communication range is antenna gain and communication channel conditions. In wireless sensor network, conditions of the area affect the signal strengthened and how well the antenna can transmit and receive is something that needs to be emphasized.

There are restrictions on the antenna gain, since the antenna in sensor nodes are small. The omni-directional antenna had used to give node ability for an effective communication in all directions. The gain of antenna in our scannerio has assumed 4 dBi for both transmitter and receiver.

- SNR and fading margin

Depending on the distance between the transmitter and the receiver and environment conditions can signal fades. A signal faces many obstacles on its way to the receiver, and this affects the signal strength. In the Star topology, it is very likely to signal fading since a signal from nodes far from the PAN can be lost and faded easily. These must be taken in designing a Star network topology. This causes that coverage area for Star topology limited.

The most applications of Star form are not built for the monitoring of large areas. In such network does not placed many sensor nodes. It is clear that the number of nodes must be sufficient enough to sense the physical events and eventual send enough data to PAN node. For indoor applications few nodes are needed to cover small areas and the system become to be simple.

Although there are long distances between nodes in the Star topology as compared to multi-hop communication, but in this topology the system complication is reduced. In this way, Star topology requires very simple data routing algorithm. The simplicity in this network topology, distinguishes this form from the other network topologies.

Mesh

In the Mesh topology, routing is necessary that the package could go further in the network.

- The transmission range

The short distances between nodes in the Mesh topology creates short hop for data transmission that affects the received power in each sensor. The received power varies with a factor of 2.5. With half of distance the received power increases of 0.17 W.

When we talk about receiving power with respect to distance, we ignore the effects of noise ratio in the environment. With a specific transmitt power can be win much of the signal when there are short distance between the transmitter and receiver.

This means that energy consumption for each sensor node will be low. In such form can be selected a low transmit power for all nodes except the last node in the route.

In term of energy consumption, the shorter hops can save a lot of energy but one must also be aware of that there are some routes between nodes in network that has not the identical SNR level. It's not the whole time the shortest route is the best alternative for data transferring.

- Data size

Each sensor node in Mesh measures temperature and sends its packet to neighboring node. This process continues until the last node in the route. This multi-hop data transferring increases the number of packet which must be sent to sink node at the last node.

- Unlike power consumption in the nodes

The different data size in each node causes different power consumption. For the nodes close to the PAN, there is a large amount of data which must be transferred. These nodes mostly uses more energy and drain down their battery rapidly.

In the wireless communication, there are different data routes with different SNR levels which effects the system performance. In the ZigBee standard by the function LQI (Link Quality Index) the quality of physical layer measures and network layer uses the most optimal route for communication. [28]

-
- Complex routing algorithm

Generally, the Mesh topology uses less energy for data transferring between two nodes but when there are many nodes in the network, the routing algorithm can be complicated.

The reason is that when a sensor will send the packet to its neighbor, it must first check its neighbor radio state. It will transmit data if the neighboring node is able to receive data (active mode). If the neighbor node is in sleep mode, the transmission of data will be delayed. The transmitter will wait for a certain time until the neighbor node wakes up and accepts the package. It will cost energy for the transmitter and delay for data delivering for the system.

- Transition power

The multi-hop communication generally uses low energy due to short distance communication between transmitter and receiver. But the transition power has also impact over the total system energy consumption.

In Mesh type network, there is always switching between different radio modes in each node. If the amount of energy used for such switching is large and node switches frequently from one state to other state, then the node energy consumption can be increased significantly. This must also be emphasized especially in Mesh topology where nodes have different responsibility for routing of data.

Such switching does not happen often in Star topology where the nodes only sense data and send to the PAN or eventually are waiting to receive a package from the PAN. The two-way communication in the Star consumes lower energy then the multi-communication in Mesh.

Mesh consists of some intermediary nodes which often switches from one state to other state for fulfill theirs responsibilities.

In our scenario, we have used the chip cc2420 which uses very low energy for transmission from a state to other. We don't take this value in our energy consumption calculation. Some characteristics of Star and Mesh network topologies are mentioned in the table 7.3.1 on page 88.

7.3 Technical Aspects

This section contains the most important parameters that are necessary to calculate energy consumption for a wireless sensor network inside the green-

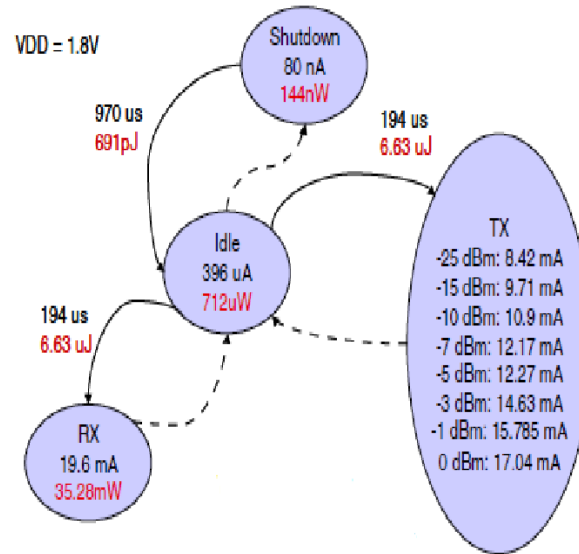

Figure 7.1: Time and power transition for chip cc2420 [30].

Topology	Advantages	Disadvantages
Star	Simple implementaion Low latency None switching between different modes Low energy consumption	Sensivite for error Small discovery area
Mesh	High capacity Large discovery area	High latency Very complex routing algorithm Large overhead

Table 7.1: The properties for CC2420 [51]

house.

7.3.1 Location of sensor nodes

One of the challenges in our job is the placement of sensor nodes in the greenhouse. As mentioned early, the location of nodes is crucial to obtain data all the time from nodes. The entire area of the greenhouse must also be covered. One must be sure that there is communication between nodes all the time and they will detect each other in neighboring area.

The area of the greenhouse has assumed to be 6m*30m*6m. And the nodes locate in the different height. The lowest value for transmitter power for cc2420 (-25 dB m) is used to calculate the minimum distance between two nodes. The receiver sensitivity for cc2420 (-95 dB m) with respect to the our fading margin (20 dB m) gives us a distance of 10 m between nodes. The calculation has done from the two equations.

$$L_{(dB)} = 25 \cdot \log_{10}(d(Km)) + 20 \cdot \log_{10}(f(GHz)) + 92.4(dB). \quad (7.1)$$

$$25 \cdot \log_{10}(d(Km)) = L_{(dB)} - 92.4(dB) - 17.4(dB).$$

$$Pr_{(dB)} = Pt_{(dB)} + G_t(dB) + G_r(dB) - L_{(dB)}. \quad (7.2)$$

For $G_t(dB) = G_r(dB) = 4$ (dB) and $Pr_{(dB)}$ for receiver (-75 dB m) can the value of $L_{(dB)}$ calculated from

$$L_{(dB)} = Pt_{(dB)} + 83(dB). \quad (7.3)$$

With replacing of the transmitter power for cc 2420, the value for $L_{(dB)}$ can be calculated. After this, we can calculate the maximum distance for when the transmitter power is (0 dB m) and minimum distance when the transmitter power is -25 dB m.

The results is 100 m for 0 dB m and 10 m for -25 dB m. Since we are using the -25 dB m in our scenario, the chosen distance between nodes will be 10 m.

- Shadowing

The obstacles in an area have great importance for signal strength. Multipath fading occurs when a signal is reflected by hitting the buildings or large

Sensor	X (m)	Y (m)	Z (m)
S1	1	0	0
S2	10	0	0
S3	15	0	2
S4	20	0	0
S5	25	0	0
PAN	0	0	5

Table 7.2: The coordinat of sensor nodes in greenhouse.

objects. This reflection creates different copies of the signal. These copies have different amplitudes and phases than the original signal. When these signals meet each other at a place, their phase differences can lead to cancel signal. In addition to the path loss, multi-path also causes the received signal falls under the receiver sensitivity. In such situation, the signal-to-noise ratio decreases and the probability for error increases.

In the areas with many obstacles where is great chance to multi-path fading, the system is planned to send a signal with high transmitter power to overcome the effects of multi-path fading. The more power, the stronger transmitted signal makes the high signal strength on the Line Of Sight and low multi-path fading effects.

In our scenario, we have considered the effect of the plants when they grow up, namely the shadowing effect. For this reason, we have placed some of sensor nodes slightly higher off the floor.

The network utilizes the sensory data from nodes at any time. Plants growing can provide difficulties for communication between wireless sensor nodes. Especially when we has used a high frequency which has a high radio signal loss.

- The number of nodes

With many nodes in the network, there is more chance to collect accurate data from the environment but it can increase the system cost for recharging of battery and network maintenance. It also increases the complexity of routing data in the network. One of the consequences of too many nodes in the network can be increasing for data collision. This must be considered when we setting up a network. The more nodes, the more packets in air and high probability for data collision.

To determine the number of nodes which is required to collect enough data, we simulated the probability of packet collision. Out of our simulation results, we have decided to put only 5 nodes for temperature measurement and a node that requires for coordinator of the system. The 5 nodes has a probabily for data collision 0.31 for a packet length of 30 bits which was the lowest value compasion to 8 and 10 nodes data collision probability.

- The packet size

The packet size also impacts the data collision. With long packet there is a high probability for data collision. But the long packet increases security for data transmission. With more bits can be addressed correctly and it can decrease data error.

The required time for sending (s) a packet of size b (Bits) is :

$$t = \frac{Packet_{length}[bit]}{datarate[bps]} \quad (7.4)$$

The maximum data rate of ZigBee protocol has introduced to be 250kbps. Zigbee supports theoretically 64000 nodes in a network and its maximum data rate is 250kbps .

- Duty cycle

The length of active mode is called the duty cycle of system. The duty cycle has high impact over system energy consumption. A network with short duty cycle can save more energy than a network with long duty cycle. The reason is, it spends short time in active mode.

Typical reporting in sensor networks is expected to be between 1 and 15 minutes but for monitoring of environmental parameters such as temperature does not need to be as often since this parameter does not change very quickly in most cases. Our system has built to send one packet once in every 15 minutes. [11]

- The transmit power

The CC2420 is a transceiver. It means that either the transmitter is on or the receiver is on but it cannot have both on at the same time.

Transmit Power (dBm)	Current Consumption (mA)
-25	8.5
-15	9.9
-10	11
-5	14
0	17.4

Table 7.3: The current consumption in CC2420 [51]

The power consumption for transmit for cc2420 is different and it depends on the size of transmission data. For large data size must uses more energy than the short data.

The transmit power for chip cc2420 ranges from -25 dBm to 0 dBm. It will consume different current for different transmit power. Table 7.3.1 shows the transmission power and current consumption for cc2420.

We have used 3 transmit power for our scenario, 0 dBm , -25 dBm and -10 dBm to analyze their impact over network energy consumption.

7.4 Methods

In this section, we concentrate us about data routing in the network for Star and Mesh form. We assume some assumption in order to make simulation more simple. The main goal is to calculate power consumption for each node and for the entire network then compared the two values for Star and Mesh Topology.

Since the most important factor for calculating the energy consumption in wireless sensor network is transceiver spending time for each radio state. I have tried to calculate the proportion of energy consumption in different radio states that each node can have.

The goal of this section is to run an algorithm for data routing that reduces the radio activity as much as possible. To calculate the chip energy consumption, we extracted only time from the code and used fixed values for various operational modes for chip cc2420 for calculation.

7.4.1 Data routing in Star

In the Star, I have assumed that the first node starts sending the packet in time t . It will check PAN radio mode, if the PAN is in sleep mode, packet transmission will delay otherwise the packet will receive at PAN. Since there are not great distances between nodes and the PAN, the signal is received on the PAN immediately after transmission. The calculated time is so short that it doesn't effect the results therefor I ignore it.

After the first node is finished with its data transferring, the neighboring node starts to communicate with the PAN. It continues to ensure that all nodes send their data. Each node sends only one packet and after sending his package goes to sleep mode and waits for the next round that will be awakened again.

The code accepts packet length and data rate such as its input values and the distance between nodes are predefined . By a simple simulation obtained power consumption for each node and the PAN.

The idle time for each node calculates by the random time that it had to wait for the PAN awakened for receiving the package.

7.4.2 Data Routing in Mesh

In the Mesh topology, the same as the Star node number 1 starts sending its data that time t to the neighbor node. The data routing continues until the last node sends its packet to PAN of the network. In each routes the node senses parameter and sends its packet to the neighbor node. It makes that the last node has many packets for sending to PAN.

The main difference in such algorithm is that each node asks the neighbor node when it has something to send which in the Star topology all nodes had communication with only PAN node. In the beginning of simulation, the distance between nodes has computed from the coordinates to sensor nodes. Due to radio state of next node, energy consumption has calculated. There is a test for receiver power level. If the received power level is less receiver sensitivity then user takes a message that signal can't be detected or it has very low signal.

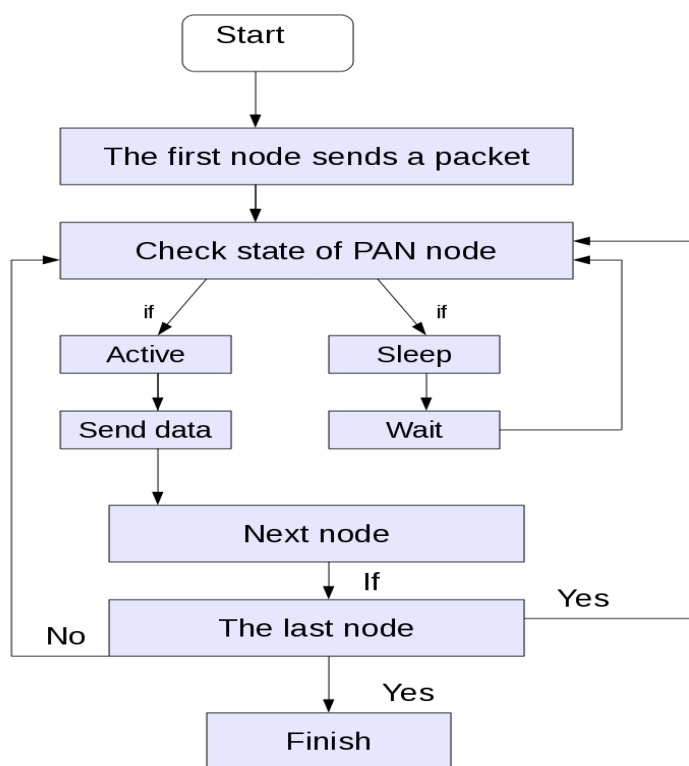

Figure 7.2: The data routing algorithm in Star.

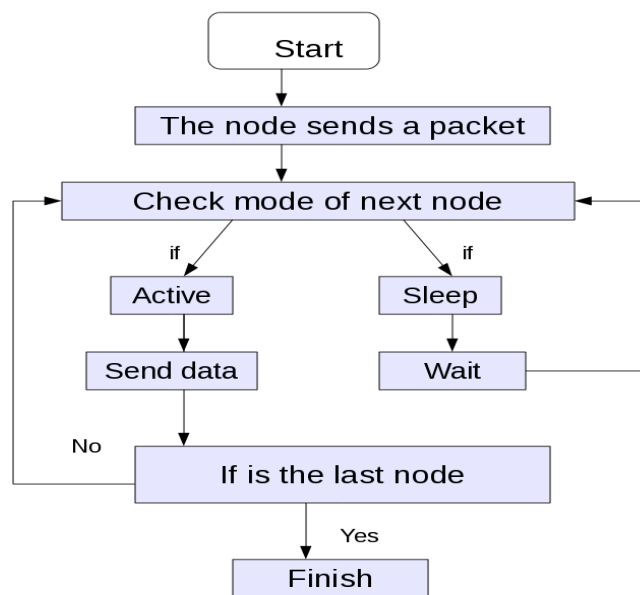

Figure 7.3: The data routing algorithm in Mesh.

7.5 Energy consumption calculating

This section is about the most required equation for calculating of energy consumption in our work.

I have computed the power consumption for a radio signal propagation in a network and second computed the energy consumption in each node.

Generally, the total energy consumption for sending 1 packet :

$$E_{packet} = E_{transmit} + E_{receive} + E_{idle} + E_{sleep} \quad (7.5)$$

I have used the below equation for power consumption for a packet:

$$P_{packet} = \frac{P_{transmit} \cdot T_{transmit} + P_{receive} \cdot T_{receive} + P_{idle} \cdot T_{idle}}{T_{duty-cycle}} \quad (7.6)$$

The energy for transmit of a radio signal has calculated from :

$$E_{transmit} = P_{max} \cdot T_{packetlength} \quad (7.7)$$

The packet length had calculated form the number of bits that requires for sending a packet of temperature measurement and the data rate (bps).

$$t_p = \frac{packetbits}{datarate} \quad (7.8)$$

P_{max} (W) is the maximum power consumption for sending a packet. It is calculated from battery voltage in V and current consumption for chip in A for transmit state.

$$P_{max} = V \cdot I_{transmit} \quad (7.9)$$

V is the battery voltage, in our case assumed 3 Volt and I is the current consumption in transmit for chip cc2420 which is equal 17.4 m A.

The transmitted power indicates how much a signal contains energy when it is sent out and can be calculated from the signal areal in time domain and signal amplitude (=P_{Txmax}).

The receiver power is dependent on transmit power P_t (W), gain of transmitter and receiver antenna, G_t and G_r (dBi), the wavelength λ (m) and the distance between the transmitter and receiver d (m). The equation below had used for this calculation:

Sensor	Radio mode	Pt (uW)	Tt (ms)	Tr (ms)	Tidle (ms)	Node Power (uW)
S1	A	0.72	12	13	0	700
S2	S-A	0.014	25	14	14	1300
S3	A	0.72	12	25	15	700
S4	S-A	0.014	25	37	15	1300
S5	S-S-A	0.014	25	50	14	1300

Table 7.4: The result for Star topology for 17.4 mA current consumption of cc2420

Sensor	Radio mode	Pr_{PAN} (uW)
S1	A	790
S2	S-A	850
S3	A	910
S4	S-A	910
S5	S-S-A	850

Table 7.5: The received power for PAN in Star topology for 17.4 mA current consumption of cc2420

$$P_{receive} = \frac{P_t \cdot G_t \cdot G_r \cdot \lambda^2}{(4\pi)^2 \cdot d^{(2.5)}} \quad (7.10)$$

7.6 Results

The results of simulation for Star and Mesh network topologies are shown in this section. The packet length, data rate, battery voltage and the number of nodes are the code input values. In our simulation, we used 30 bit for packet length, 2400 bps for data rate, 3 V battery and 5 sensor nodes for sensing temperature. These values can be changed according to applications purposes.

In the first part the results of simulation for energy consumption for a transferring of a packet has discussed and in the second one the energy used from each node to communicate other nodes has analyzed.

The figure 7.6 on page 97 shows the different power consumption for nodes in Star topology. The PAN radio mode influence the power consumption for each node. Since it can be in a sleep or active mode then the power

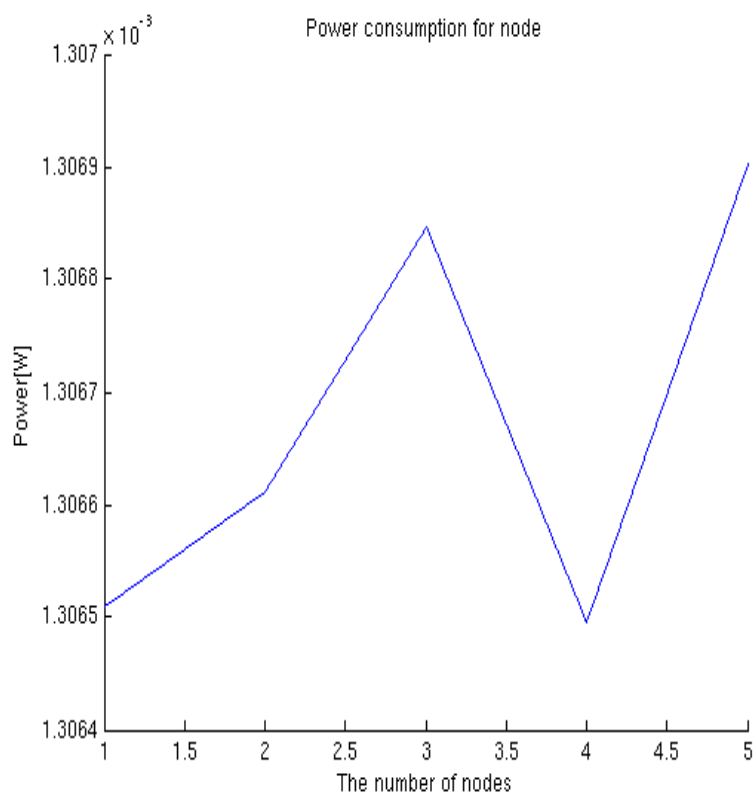

Figure 7.4: Power consumption for each node in Star topology .

Sensor	Radio mode	Pt (uW)	Tt (ms)	Tr (ms)	Tidle (ms)	Node Power (uW)
S1	A	0.72	12	0	0	0.72
S2	A	1.4	25	12	0	2.2
S3	S-S-A	4.3	75	25	94	7.2
S4	S-S-A	5.8	100	37	25	8.6
S5	A	3.6	62	50	0	6.9

Table 7.6: The result for Mesh topology for 17.4 mA current consumption of cc2420

Power consumption in Star (uW)	Power consumption in Mesh (uW)
1600	8.9
1900	10.3
1800	7.9

Table 7.7: The power consumption for Star and Mesh topologies with current consumption 17.4 mA for cc2420.

consumption for each node can vary often. It is the reason for a big difference between values in the figure 7.6.

The transmit power for a sensor node has calculated from the below equations where the N is the number of packet and Pt_{S1} is the transmit power for the first node which is dependent on the current consumption of chip in transmit mode.

For node in sleep mode, see table 7.6:

$$Pt_{SN} = N \cdot 2Pt_{S1}. \quad (7.11)$$

For node in active mode, see table 7.6:

$$Pt_{SN} = N \cdot Pt_{S1}. \quad (7.12)$$

Power consumption for a node can calculated from the below equation:

$$P_{SN} = v \cdot I_t \cdot T_{transmit} + v \cdot I_{received} \cdot T_{received} + v \cdot I_{idle} \cdot T_{idle}. \quad (7.13)$$

From the figure 7.6 on page 99 can be seen that the power consumption for the last node in the Mesh topology is the highest.

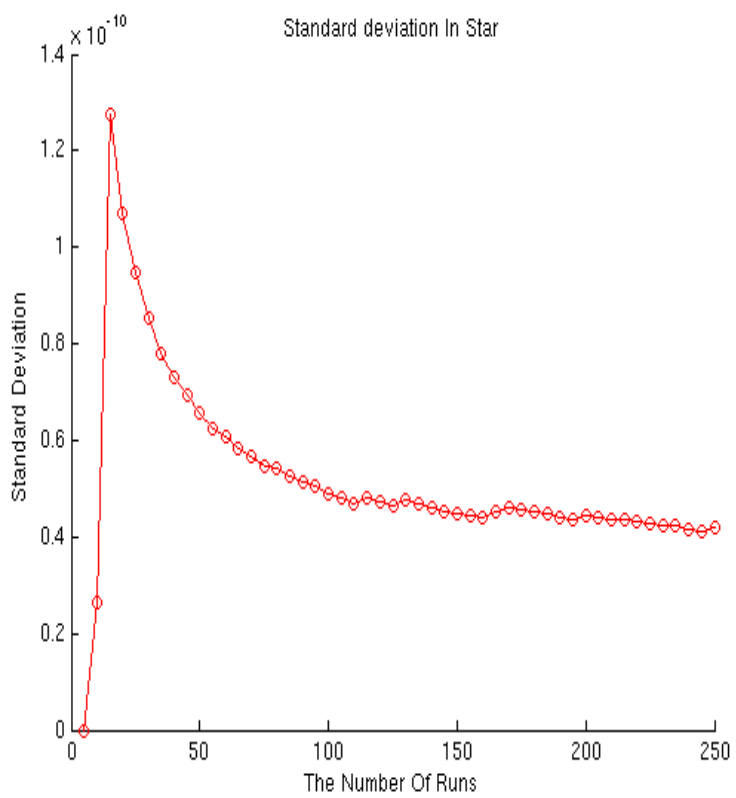

Figure 7.5: The standard variation for a Star network.

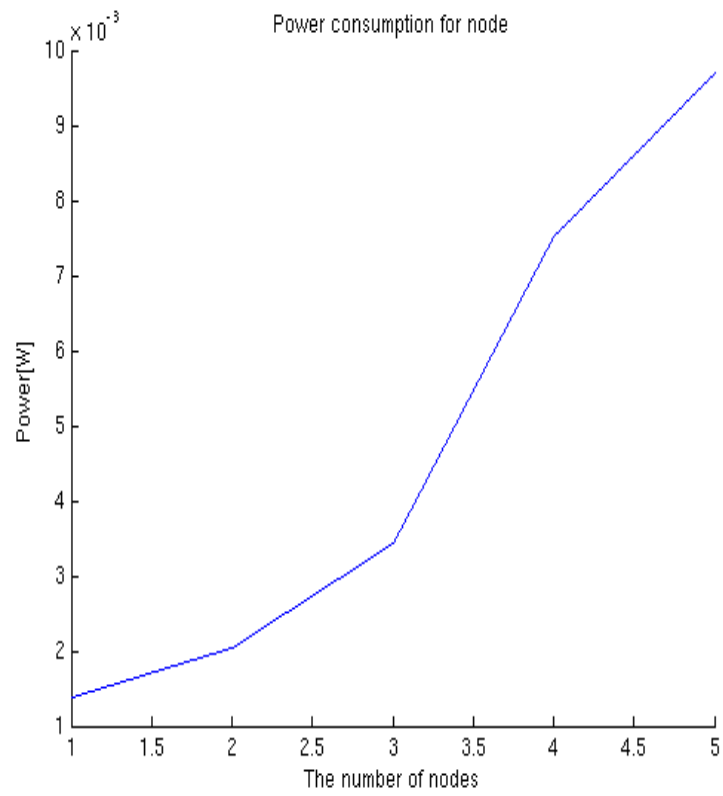

Figure 7.6: Power consumption for each node in Mesh topology .

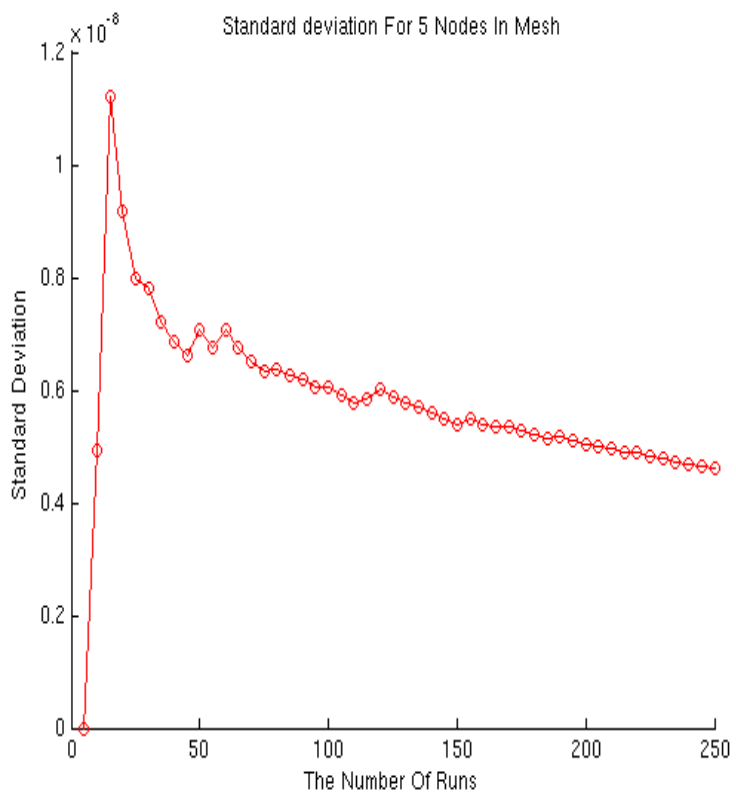

Figure 7.7: The standard variation for a Mesh network.

7.7 Summary

To meet the multi-year application requirements each sensor node consumes low power for its communication.

We have different challenges in different layer in wireless sensor network designing. In the physical layer, we should locate nodes in the right place to cover the area of the greenhouse and provide secure data transferring between nodes. In Mac layer, we have calculated the probability of data collision. In Network layer, we have tried to find the optimal data routing between nodes in the network. In the application layer the main goal is to give ability for end user to be informed about the conditions of greenhouse.

In this chapter we have included the results of simulations and tried to explain some technical parameters. The methods for data routing and the necessary equations are discussed.

A random function has chosen to ensure random radio mode for each sensor node when the data will send in both network topologies. In addition, we have checked the results with a test file. The test file takes average power consumption of network for each topology as its input and tests it. The test file is based on the worst case (when all nodes are in sleep mode) and best cases (when all nodes are in active mode) for data transmission in both network.

Chapter 8

Evaluation

This chapter is about our analysis and conclusion.

8.1 Analysis

A low power consumed in data transmission and idle mode, can decrease energy consumed significantly. Duty cycle is also an important factor to defining power consumption in a node. With a low power consumption in transmitt/receive and a short duty cycle, can be saved a lot of energy in a node. These two parameters must be taken into consideration simultaneously. The power consumption for a node depends on node characteristic and design. But duty cycle can be defined by data routing algorithm. A short duty cycle can be achieved with often switching between the radio transceiver states.

- Star Topology

The data routing algorithm in Star allows all nodes send their data to PAN node. It is a one way communication and nodes do not receive any data from PAN. Transmit power is only power consumption at node. Each node senses temperature and sends its data to PAN. Since each node sends only one packet, transmit time for all nodes must be identical. This transmit time depends on PAN node radio state. For cases where PAN is in sleep mode, transmit time must be delayed. This delayed time increases transmit time thereby node uses more power for transmission of data. Retransmission of packet doubles power transmit for a node.

The required time for a packet transmission calculates from data rate [bps] and packet length in bit. Due to very short time for propagation of a signal in our scenario, a transmit signal receives immediately in PAN node. The receiving time for a signal is equal transmission time for a packet. PAN node will accept 5 packets from 5 nodes and will send data to gateway node. I have not calculated power consumption for sending such data from PAN to gateway.

When PAN is in sleep mode, transmit must occurs twice. It increases power consumption for a node which will send its own packet to PAN. Routing algorithm in Star, allows that a PAN can be in sleep mode for a certain time. I had defined a limitation value for sleeping time for PAN. Checking of PAN node radio mode can occurs maximum 10 times. After 10 times, packet will send to PAN.

A long waiting time for packet transmission increases power consumption for a node. Idle time for a node increases with random value (ms) until PAN wakes up and receives packet.

The results shows that a Star topology for this scenario can consume high energy.

- Mesh

Generally, the Mesh topology uses less energy for data transferring between two nodes but when there are many nodes in the network, the routing algorithm can be complicated.

Except to the first node, all nodes in this topology consume power for transmitting and receiving a packet. The first node initial data routing with sending its packet. Two- ways communication occurs among the other nodes.

I have calculated the received and transmitt power for all nodes in both network topologies. The radio state of the nodes checks with a random function in Mat Lab. Despite to the node radio mode the transmitt, received and idle time for each state will calculated.

As the results shows the nodes with long idle time have high power consumption than the others in the network. The packet length here is some of the important parameters. The amount of data increses with the number of nodes and it causes that a node uses more energy to transferring its data to the next node.

The transmit power for the first node in Star and Mesh topology is the same. Because the first node in Mesh topology will just send one packet. Packet length for both topologies is the same.

8.2 Conclusion

We have two different network topologies to choose from, namely Star and Mesh. In principle, it is essential to set up a wireless sensor network is among other things, energy, maintenance costs. In our scenario, which is about a limited area of Indore with fewer nodes, fewer obstructions, and short distances will mesh their best. Theoretically, the Star topology should be a better alternative for indoor applications. But our simulation results show that for the our scenario the Mesh topology yields less power consumption of the whole sensor network. This might be done to the specific scenario and needs further investigating.

Chapter 9

Referances

[1] B. Krishnamachari, D. Estrin and S. Wicker. “Modeling Data Centric Routing in Wireless Sensor Networks”. in the Proceedings of IEEE INFOCOM, New York, NY, June 2002.

[2] G. Ferrari¹, P. Medagliani¹ and M. Martalo¹. “PERFORMANCE ANALYSIS OF ZIGBEE WIRELESS SENSOR NETWORKS WITH RELAYING”. Wireless Ad-hoc and Sensor Networks (WASN) Laboratory, Department of Information Engineering, University of Parma, Italy.

[3] Maxim Osipov. “Home Automation with ZigBee”. OOO Siemens Corporate Technology, St.Petersburg, 2008.

[4] William C. Craig. “Zigbee: Wireless Control That Simply Works”.

[5]. Jennifer Yick, Biswanath Mukherjee and Dipak Ghosal. “Wireless sensor network survey”. Department of Computer Science, University of California, United States. 2008.

[6]. Håkon K. Olafsen. “Wireless Sensor Network Localisation Strategies”.UNIVERSITY OF OSLO Department of informatics. May 2007.

[7]. Tod Riedel and Millennial Net. “Self-organizing, Wireless Sensor Networks”. April/May 2004.

[8]. Anis Koubaa, Mario Alves and Eduardo Tovar. “Technical Report,

IEEE 802.15.4 for Wireless Sensor Networks: A Techniacal Overview”. TR-050702. July 2005.

[9]. <http://kareem-ashraf.blogspot.com/2009/10/2-network-topologies-figure-2.html>.

[10]. F. L. LEWIS.“ Wireless Sensor Networks”. The University of Texas at Arlington. 2004.

[11]. Jason Lester Hill. “System Architecture for Wireless Sensor Networks”. Spring 2003.

[12]. Khaled Shuaib, Maryam Alnuaimi, Mohamed Boulmalf, Imar Jawhar, Farag Sallabi and Abderrahmane Lakas. “Performance evaluation of IEEE 802.15.4: Experimental and Simulation Results”. College of Information Technology, UAE University. JUNE 2007.

[13]. Saad Ahmad Khan, Fahad Ahmad Khan, Arslan Shahid and Zubair Ahmad Khan. “Zigbee Based Reconfigurable Clustered Home Area Network“. 2009.

[14]. Jamal N. Al-Karaki and Ahmed E. Kamal.”Routing Techniques in Wireless Sensor Networks: A Survey“. Dept. of Electrical and Computer Engineering, Iowa State University, Ames, Iowa 50011.

[15]. Andrzej Pawlowski, Jose Luis Guzman, Francisco Rodríguez, Manuel Berenguel, José Sánchez and Sebastián Dormido. ”Simulation of Greenhouse Climate Monitoring and Control with Wireless Sensor Network and Event-Based Control“. *Sensors* 2009, 9, 232-252; doi:10.3390/s90100232.

[16]. Arrian Prince-Pike.”Power Characterisation of a Zigbee Wireless Network in a Real Time Monitoring Application“. 2009.

[17]. Jackson Francomme, Gilles Mercier and Thierry Val. ”A simple method for guaranteed deadline of periodic messages in 802.15.4 cluster cells for automation control applications“. 2007.

[18]. KF Tsang, WC Lee, KL Lam, HY Tung and Kai Xuan.” An Inte-

grated ZigBee Automation System: An Energy Saving Solution“. 2008.

[19]. Chris Townsend and Steven Arms. "Wireless Sensor Networks: Principles and Applications“.

[20]. Hui Liu, Zhijun Meng and Shuanghu Cui. "A Wireless Sensor Network Prototype for Environmental Monitoring in Greenhouses“. 2007.

[21]. Dae-Heon Park, Beom-Jin Kang, Kyung-Ryong Cho, Chang-Sun Shin, Sung-Eon Cho, Jang-Woo Park and Won-Mo Yang. "A Study on Greenhouse Automatic Control System Based“. Wireless Pers Commun. 2009.

[22]. Holger Karl and Andreas Willing. "Protocols and architectures for Wireless Sensor Networks“. 2005.

[23]. Zigbee."GreenPeak Technologies and ZigBee: Harvesting Power In the Wireless Greenhouse of the Future “.

[24]. Liu Yanfei Wang Cheng Qiao Xiaojun Zhang Yunhe and Yu chengbo. "An Improved Design of ZigBee Wireless Sensor Network“.

[25]. Hyun-joong Kang, Meong-hun Lee, and Hyun Yoe."Effect of Sensor Specific Crop Location on Wireless Sensor Network Performance“. School of Information and Communications Engineering, Sunchon National Univ. Korea.

[26]. Teemu Ahonen, Reino Virrankoski and Mohammed Elmusrati. "Greenhouse Monitoring with Wireless Sensor Network “. University of Vaasa ,Department of Computer Science,Telecommunication Engineering Group, Finland.

[27]. T.C.Manjunath, Ph.D. (IIT Bombay) Fellow IETE, Ashok Kusagur , Shruthi Sanjay, Saritha Sindushree and C. Ardil. "Design, Development Implementation of a Temperature Sensor using Zigbee Concepts “. International Journal of Electrical and Information Engineering 2:4 2008.

[28]. Erik Undheim." Evaluering av ytelsen til den kommende ZigBee-standarden for traadløse sensornettverk.“ 2004.

[29]. Øyvind Kleppe Asphjell. "Biomedisinske sensornettverk basert på Ultra Wide Band impulsradio og IEEE 802.15.4/Zigbee". 2007.

[30]. Bruno Bougard, Francky Catthoor, Denis C. Daly, Anantha Chandrakasan and Wim Dehaene. "Energy Efficiency of the IEEE 802.15.4 Standard in Dense Wireless Microsensor Networks: Modeling and Improvement Perspectives." Proceedings of the Design, Automation and Test in Europe Conference and Exhibition (DATE'05).

[31]. InTech."ZigBee sensors live on five-year battery". 1 April 2005

[32]. Freescale Semiconductor Application Note. "IEEE® 802.15.4 / ZigBee Software Selector Guide". 2007.

[33]. www.rfdesignline.com/showArticle.jhtml

[34]. Azni Haslizan Ab.Halim and Kartinah Zen." MAC Protocol to Reduce Packet Collision in Wireless Sensor Network". Proceedings of the International Conference on Computer and Communication Engineering 2008.

[35]. Bahareh Gholamzadeh and Hooman Nabovati. "Concepts for Designing Low Power Wireless Sensor Network". World Academy of Science, Engineering and Technology 45 2008.

[36]. Syed Jawad Ali and Partha Roy." Energy Saving Methods in Wireless Sensor Networks (Based on 802.15.4)". Technical report, IDE0814, May 2008.

[37]. Texas Instruments. "MSP430 for Wireless Applications".

[38]. Rozeha A. Rashid, Wan Mohd Ariff Ehsan W. Embong, Azami Zaharim and Norsheila Faisal. "Development of Energy Aware TDMA-Based MAC Protocol for Wireless Sensor Network System." European Journal of Scientific Research, ISSN 1450-216X Vol.30 No.4 (2009), pp.571-578, 2009.

[39]. C. Gomez, P. Salvatella, O. Alonso and J. Paradells. "Adapting AODV for IEEE 802.15.4 Mesh Sensor Networks: Theoretical Discussion

and Performance Evaluation in a Real Environment“. Wireless Networks Group, Entel Dept., Technical University of Catalonia (UPC). 2006.

[40]. National Institute Of Standards And Technology. ”Mobile Ad Hoc Networks (MANETs)“.

[41]. Tech Terms.com. ”MANET (Mobile Ad Hoc Network)“.

[42]. Jennifer A. Hartwell, Geoffrey G. Messier and Robert J. Davies. ”Optimizing Physical Layer Energy Consumption for Wireless Sensor Networks“. Department of Electrical Computer Engineering and TRILabs, University of Calgary, Canada.

[43]. I.F. Akyildiz, W. Su, Y. Sankarasubramaniam and E. Cayirci. ”Wireless sensor networks: a survey“. Georgia Institute of Technology. 2002.

[44]. Karl Benkic, Peter Planinsic and Zarko Cucej. ” Custom Wireless Sensor Network based on ZigBee“. 49th International Symposium ELMAR-2007, 12-14 September 2007, Zadar, Croatia.

[45]. Paul Sereiko. ”Wireless Mesh Sensor Networks Enable Building Owners, Managers, and Contractors to Easily Monitor HVAC Performance Issues“.

[46]. Dr. O. Vermesan. ”Ubiquitous Wireless Sensor Networks and future Internet of Things“. SINTEF, Norway.

[47]. White Paper, Cirronet, Inc, Fall 2005, ” RF Power Option in ZigBee Solution“.

[48]. Berkeley Seminar 2007, www.iicbelgrado.esteri.it/IIC_sanFrancisco/we.

[49]. <http://manasvirajmehta.blogspot.com>

[50]. Othman Sidek, Muhammad Qayum Omar, Hashim Edin, Khairu Anuar Mohamed Zain and Muhamad Azman Miskam. ” Preliminary Infrastructure Development for Greenhouse Accounting of Malaysian Rainforest Using Wireless Sensor Network“. European Journal of Scientific Research.

2009.

[51]. Chipcon, from Texas Instruments.” 2.4 GHz IEEE 802.15.4 / ZigBee-ready RF Transceiver,CC2420“.

[52]. Marwan Ihsan Shukur, Lee Sheng Chyan and Vooi Voon Yap. ”Wireless Sensor Networks:Delay Guarentee and Energy Efficient MAC Protocols“. World Academy of Science, Engineering and Technology 50 2009.

9.1 Appendix A

```
1 function [ pr_collision] = collision_new(m, numBits);
2
3 for i=1:m
4     M=i;
5     %The number of simulations
6     N=100;
7     t=0;
8     T=0;
9
10    for i=1:N
11        % Generate random data
12
13        r = randi(numBits-M+1,1);
14        for i=1:numBits
15
16            if i>=r & i<r+M
17                S(i)=1;
18            else
19                S(i)=0;
20            end
21
22        end
23        s1=S;
24
25        r = randi(numBits-M+1,1);
26        for i=1:numBits
27
28            if i>=r & i<r+M
29                S(i)=1;
30            else
31                S(i)=0;
32            end
33
34        end
35        s2=S;
36        r = randi(numBits-M+1,1);
37        for i=1:numBits
38
39            if i>=r & i<r+M
40                S(i)=1;
41            else
```

```
42     S(i)=0;
43 end
44
45 end
46 s3=S;
47 r = randi(numBits-M+1,1);
48 for i=1:numBits
49
50     if i>=r & i<r+M
51         S(i)=1;
52     else
53         S(i)=0;
54     end
55
56 end
57 s4=S;
58 r = randi(numBits-M+1,1);
59 for i=1:numBits
60
61     if i>=r & i<r+M
62         S(i)=1;
63     else
64         S(i)=0;
65     end
66
67 end
68 s5=S;
69 r = randi(numBits-M+1,1);
70 for i=1:numBits
71
72     if i>=r & i<r+M
73         S(i)=1;
74     else
75         S(i)=0;
76     end
77
78 end
79 s6=S;
80 r = randi(numBits-M+1,1);
81 for i=1:numBits
82
83     if i>=r & i<r+M
84         S(i)=1;
85     else
86         S(i)=0;
```

```

87
88 end
89 s7=S;
90 r = randi(numBits-M+1,1);
91 for i=1:numBits
92
93     if i>=r & i<r+M
94         S(i)=1;
95     else
96         S(i)=0;
97     end
98
99 end
100 s8=S;
101 r = randi(numBits-M+1,1);
102 for i=1:numBits
103
104     if i>=r & i<r+M
105         S(i)=1;
106     else
107         S(i)=0;
108     end
109
110 end
111 s9=S;
112 r = randi(numBits-M+1,1);
113 for i=1:numBits
114
115     if i>=r & i<r+M
116         S(i)=1;
117     else
118         S(i)=0;
119     end
120
121 end
122 s10=S;
123 for k=1:7
124     c=and(S(k),S(k+1));
125 end
126 if max(c)== 1;
127     fprintf('collision');
128     t=t+1;
129 end
130 if t>0
131     T=T+1;

```

```
132 end
133 t=0;
134 end
135 fprintf ('The Number Of Simulation')
136 N
137 fprintf (' The Number Of Bits')
138 numBits
139 fprintf(' The Length Of Packet')
140 M
141 fprintf ('Probability For Collision')
142 T=T;
143 pr_collision=T/100;
144 end
```

```
1 function [ pr ] = br;
2 clc
3 clear
4 % Maximum packet size in IEEE 802.15.4 is 123 bytes.
5 % Probability for bits error is depend
6 %on the received power
7 % Bbit=2.35*10^(-30) *exp(-0.659*pr);
8 % Here I assumed the simple version of this formule.
9
10 % Pr(received)= Pt(transmitt) - A(path loss);
11 % -15 dBm < Pt< 0 dBm or 9.71 mA <Tx< 17.4 mA
12 %from data sheet til cc2420
13
14
15 % For AWGN, packet error probability as a
16 %function of received power.
17
18 % x = 10 *log10(P) + 30 , X in dBm and P in W.
19 % P = 10^(x/10)/1000
20
21 % The nodes positions
22 sensor_x=[1 10 15 20 25];
23 sensor_y=[0 0 0 0 0];
24 sensor_z=[0 0 2 0 0];
25
26 % The PAN position
27 bs_x=[0];
28 bs_y=[0];
29 bs_z=[5];
30
```

```

31 % The transmit power for cc2420
32 % Three transmit power
33 % 0, -10 and -25 dBm
34
35 pt1=0 ;
36 ptt1=(10^(pt1/10))/1000;
37
38 pt2=-15;
39 ptt2=(10^(pt2/10))/1000;
40
41 pt3=-25;
42 ptt3=(10^(pt3/10))/1000;
43
44 % Receiver sensitivitiy for cc2420
45 sens_cc=-95;
46 fad_marg=20;
47 my_case =sens_cc + fad_marg;
48 Rs=(10^(my_case/10))/1000;
49
50 % Antenna gain and wave length
51 Gt=4;
52 Gr=4;
53 C=3e8;
54 f=2.4e9;
55 l=C/f;
56
57
58 N=5
59 for i=1:N-1
60
61 r(i)=sqrt((sensor_x(i+1) -sensor_x(i))^2+...
62         (sensor_y(i+1) -sensor_y(i))^2+(sensor_z(i+1)+...
63         - sensor_z(i))^2)
64
65 % The distance for lowest transmitt power
66 R_optimal=10;
67 p=ptt3*((l)^2);
68 prr=(p*Gt*Gr)/(R_optimal)^(2.5);
69 prR(i)=(prr/((4*pi)^2));
70 Pr_bitR= exp(prR);
71
72 % if Pr_bitR<Rs
73 %     fprintf('signal optimal is very low');
74 % end
75 %

```



```

76  % The received power
77
78  p=ptt1*((l)^2);
79  prr=(p*Gt*Gr)/(r(i))^(2.5);
80  pr1(i)=(prr/((4*pi)^2));
81  if pr1(i)<Rs
82      fprintf('signal1 is very low');
83  end
84
85  p=ptt2*((l)^2);
86  prr=(p*Gt*Gr)/(r(i))^(2.5);
87  pr2(i)=(prr/((4*pi)^2));
88  if pr2(i)<Rs
89      fprintf('signal2 is very low');
90  end
91
92  p=ptt3*((l)^2);
93  prr=(p*Gt*Gr)/(r(i))^(2.5);
94  pr3(i)=(prr/((4*pi)^2));
95  if pr3(i)<Rs
96      fprintf('signal3 is very low');
97  end
98  end
99
100 i=N
101 % Distance from the leats node to PAN node
102
103 r(i)=sqrt((bs_x -sensor_x(i))^2+ (bs_y - sensor_y(i))^2 + ...
104          (bs_z - sensor_z(i))^2)
105
106 p=ptt1*((l)^2);
107 prr=(p*Gt*Gr)/(r(i))^(2.5);
108 pr1(i)=(prr/((4*pi)^2));
109
110 p=ptt2*((l)^2);
111 prr=(p*Gt*Gr)/(r(i))^(2.5);
112 pr2(i)=(prr/((4*pi)^2));
113
114
115 p=ptt3*((l)^2);
116 prr=(p*Gt*Gr)/(r(i))^(2.5);
117 pr3(i)=(prr/((4*pi)^2));
118
119 % The probability for bit error
120

```

```

121 Pr_bit1= exp(0.6*pr1);
122 Pr_bit2= exp(0.6*pr2);
123 Pr_bit3= exp(0.6*pr3);
124
125 pr1=pr1*10^(6)
126 pr2= pr2*10^(6)
127 pr3= pr3*10^(6)
128
129 Rs=Rs*10^(6)
130
131
132
133 figure(2)
134 hold on
135 for R=1:1:20
136
137 pbit1=exp(-R);
138 xlabel('Received Power [mW]');
139 ylabel('Probability for bit error');
140 title('Received Power versus Prbit');
141 plot( R,pbit1,'--bo');
142
143 end
144
145
146 end
147
148 % Analysis:
149 % Low probability for bits error and
150 %small packet size, decreases
151 % probability for error and collision.
152 %With other words, high transmitt
153 % power and low signal fading and
154 %low path loss makes a high level for
155 % received power which makes
156 %the probability for bits error decreases.
157 % With small packet can decreases
158 %probability for collision.

```

```

1
2 function [p_chip_network]=Mesh_power(L,N,v,Datarate,Itt,sens)
3
4 fprintf('Mesh')
5 sensor_x=[1 10 15 20 25];

```

```
6 sensor_y=[0 0 0 0 0];
7 sensor_z=[0 0 2 0 0];
8
9 % The PAN position
10 bs_x=[0];
11 bs_y=[0];
12 bs_z=[5];
13
14 % Current consumption for cc2420
15 % In different radio modes
16 It=Itt*10(-3);
17 Ir=19.7*10(-3);
18 Ii=396*10(-6);
19 % Receiver sensivity
20 Rs=(10(sens/10))/1000;
21 p_max=v*It;
22 PI= v*Ii;
23 % Antenna gain and wave length
24 Gt=4;
25 Gr=4;
26 C=3e8;
27 f=2.4e9;
28 l=C/f;
29 % Packet length(s)
30 Lp=L;
31 tp=Lp/Datarate;
32 % Checking of radio state
33 for i=1:N
34     mode=rand
35
36     if mode ≤ 0.5
37         td(i)=rand;
38         ti(i)=tp+td(i);
39         mode=rand
40
41         while mode ≤ 0.5
42             td2=rand;
43             ti(i)=ti(i)+td2 ;
44             mode=rand
45         end
46         % Power=Energy/time
47         % In 15min=900 s
48         ptt=(i*p_max*tp)/900);
49         pt(i)=2*ptt;
50         tt(i)=2*i*tp;
```

```

51  if i<N
52  r(i)=sqrt((sensor_x(i+1) -sensor_x(i))^2+ (sensor_y(i+1) -...
53      sensor_y(i))^2+(sensor_z(i+1) - sensor_z(i))^2)
54  % The calculation of received power
55  p=ptt*(l)^2;
56  prr=(p*Gt*Gr)/(r(i)^(2.5));
57  pr(i+1)=(prr/((4*pi)^2));
58  tr(i+1)=i*tp;
59  % The checking of signal strength
60  if pr(i+1)<Rs
61      fprintf('signal is very low');
62  end
63  end
64  else
65  ptt=(i*p_max*tp/900);
66  pt(i)=ptt;
67  tt(i)=i*tp;
68  ti(i)=0;
69  if i<N
70  r(i)=sqrt((sensor_x(i+1) -sensor_x(i))^2+ (sensor_y(i+1) -...
71      sensor_y(i))^2+(sensor_z(i+1) - sensor_z(i))^2)
72
73  p=ptt*(l)^2;
74  prr=(p*Gt*Gr)/(r(i)^(2.5));
75  pr(i+1)=(prr/((4*pi)^2));
76  tr(i+1)=i*tp;
77  if pr(i+1)<Rs
78      fprintf('signal is very low');
79  end
80  end
81  end
82  Tt(i)=tt(i);
83  Tidle(i)=ti(i);
84  if i<N
85  Tr(i+1)=tr(i+1);
86  end
87  if i==1
88  pr(i)=0;
89  Tr(i)=0;
90  end
91  % The energy consumption for each chip
92  P_chip(i)=(v*It*Tt(i) + (v*Ir*tr(i) + v*Ii*Tidle(i)))/900;
93  P_average_chip=mean(P_chip);
94  Pt=pt(i);
95  Pr=pr(i);

```

```

96 end
97
98 % The PAN node
99 i=N;
100 pt=(i*p_max*tp/900);
101 r(i)=sqrt((bs_x -sensor_x(i))^2+ (bs_y - sensor_y(i))^2 +...
102         (bs_z - sensor_z(i))^2)
103 p=pt*((l)^2);
104 pr=p*Gt*Gr/(r(i))^(2.5);
105 PR=(pr/((4*pi)^2)) ;
106 if PR<Rs
107     fprintf('signal is very low');
108 end
109 Tr=i*tp;
110 Ti=0.038;
111 P_PAN=((PR*Tr )+ (PI*Ti))/900;
112 P_chip_pan= ((v*Ir*Tr)+(v*Ii*Ti))/900;
113 p_chip_network= P_average_chip + P_chip_pan;
114 pt
115 end

```

```

1 function [Test]=test_mesh(L,N,v,Datarate,Itt,sens)
2
3     fprintf('TEST Mesh');
4     sensor_x=[1 10 15 20 25];
5     sensor_y=[0 0 0 0 0];
6     sensor_z=[0 0 2 0 0];
7     % The PAN position
8     bs_x=[0];
9     bs_y=[0];
10    bs_z=[5];
11    % Current consumption for cc2420
12    % In different radio modes
13    It=Itt*10^(-3);
14    Ir=19.7*10^(-3);
15    Ii=396*10^(-6);
16    % Receiver sensitvity
17    Rs=(10^(sens/10))/1000
18    p_max=v*It;
19    PI= v*Ii;
20    % Antenna gain and wave length
21    Gt=4;
22    Gr=4;
23    C=3e8;

```

```

24 f=2.4e9;
25 l=C/f;
26 % Packet length(s)
27 Lp=L;
28 tp=Lp/Datarate;
29 for i=1:N
30 ptt=(i*p_max*tp)/900;
31 pt(i)=ptt;
32 tt(i)=i*tp;
33 ti(i)=0;
34 if i<N
35 r(i)=sqrt((sensor_x(i+1)-sensor_x(i))^2+...
36           (sensor_y(i+1)-sensor_y(i))^2+...
37           (sensor_z(i+1)-sensor_z(i))^2);
38
39 p=ptt*(l^2);
40 prr=(p*Gt*Gr)/(r(i)^(2.5));
41 pr(i+1)=prr/((4*pi)^2);
42 tr(i+1)=i*tp;
43 end
44 Tt(i)=tt(i);
45 Tidle(i)=ti(i);
46 if i<N
47 Tr(i+1)=tr(i+1);
48 end
49 if i==1
50 pr(i)=0;
51 Tr(i)=0;
52 end
53 % The worst case
54 % All nodes are in sleep mode
55 Pmm_chip(i)=(v*It*Tt(i)+(v*Ir*tr(i)+(v*Ii*Tidle(i)));
56 end
57 P_avreage=mean(Pmm_chip);
58 i=N;
59 pt=(i*p_max*tp)/900;
60 r(i)=sqrt((bs_x-sensor_x(i))^2+...
61           (bs_y-sensor_y(i))^2+...
62           (bs_z-sensor_z(i))^2);
63
64 p=pt*(l^2);
65 prr=(p*Gt*Gr)/(r(i)^(2.5));
66 PR=(prr/((4*pi)^2));
67 Tr=i*tp;
68 Ti=0.038;

```

```

69 P_PAN_mm=((PR*Tr )+ (PI*Ti))/900;
70 p_chip_network_Min=(P_avreage + P_PAN_mm);
71 for i=1:N
72
73 SleepNum=1;
74 % Here assume that just 10 times node can be
75 % in sleep node
76 while SleepNum <10
77
78
79 td2=0.5;
80 ti(i)=ti(i)+td2 ;
81 SleepNum=SleepNum+1;
82 end
83 ptt=(i*p_max*tp)/900;
84 pt(i)=(2*ptt);
85 tt(i)=2*i*tp;
86 if i<N
87 r(i)=sqrt((sensor_x(i+1) -sensor_x(i))^2+ ...
88 (sensor_y(i+1) - sensor_y(i))^2+...
89 (sensor_z(i+1) - sensor_z(i))^2);
90
91 p=ptt*((l)^2);
92 prr=(p*Gt*Gr)/(r(i))^(2.5);
93 pr(i+1)=(prr/((4*pi)^2));
94 tr(i+1)=i*tp;
95 end
96 Tt(i)=tt(i);
97 Tidle(i)=ti(i);
98 if i<N
99 Tr(i+1)=tr(i+1);
100 end
101 if i==1
102 pr(i)=0;
103 Tr(i)=0;
104 end
105 % The best case
106 % All nodes are in active mode
107 Pmx_chip(i)=(v*It*Tt(i))+ (v*Ir*tr(i))+ (v*Ii*Tidle(i));
108 end
109 P_avreage=mean(Pmx_chip);
110 i=N;
111 pt=(i*p_max*tp/900);
112 r(i)=sqrt((bs_x -sensor_x(i))^2+ ...
113 (bs_y - sensor_y(i))^2 +(bs_z - sensor_z(i))^2);

```

```

114 p=pt*((l)^2);
115 prr=(p*Gt*Gr)/(r(i)^(2.5));
116 PR=(prr/((4*pi)^2));
117 Tr=i*tp;
118 Ti=0.038;
119 P_PAN_mx=((PR*Tr)+(PI*Ti))/900);
120 p_chip_network_Max=(P_avreage + P_PAN_mx);
121 Out= Mesh_power(L,N,v,Datarate,Itt,sens)
122 p_min= p_chip_network_Min;
123 p_max= p_chip_network_Max;
124 % The checking of result
125 if ( p_min ≤ Out && Out ≤ p_max)
126     fprintf('Correct')
127
128     Test=1;
129 else
130     fprintf('Fail')
131     Test=0
132 end
133
134
135 end

```

```

1 function p=run_mesh(L,N,v,Datarate,Itt,sens);
2 L=L;
3 N=N;
4 v=v;
5 Datarate=Datarate;
6
7 r(1)=5;
8
9 for j=1:50
10
11     for i=1:r(j)
12         [Out(i)]=Mesh_power(L,N,v,Datarate,Itt,sens);
13     end
14
15     p(j)=mean(Out);
16     r(j+1)=r(j)+5;
17     BB(j)=r(j);
18     s(j) = std(p)
19
20
21 end

```



```
22
23 figure(1);
24 hold on;
25 title('Mean Power Consumption For 5 Nodes In Mesh');
26 xlabel('The Number Of Runs');
27 ylabel('Standard Deviation');
28 plot(BB,p, '-ro');
29 hold off;
30
31 figure(2);
32 hold on;
33 title('Standard deviation For 5 Nodes In Mesh');
34 xlabel('The Number Of Runs');
35 ylabel('Standard Deviation');
36
37 plot(BB,s, '-ro');
38 hold off;
39
40
41
42
43 end
```

```
1
2 function [ P_chip_network]=Star_power(L,N,v,Datarate,Itt,sens);
3 fprintf('Star')
4 sensor_x=[1 10 15 20 25];
5 sensor_y=[0 0 0 0 0];
6 sensor_z=[0 0 2 0 0];
7
8 % The PAN position
9 bs_x=[0];
10 bs_y=[0];
11 bs_z=[5];
12 % Current consumption for cc2420
13 % In different radio modes
14 It=Itt*10(-3);
15 Ir=19.7*10(-3);
16 Ii=396*10(-6);
17 % Receiver sensivity
18 Rs=(10(sens/10))/1000;
19 p_max=v*It;
20 PI= v*Ii;
21 % Antenna gain and wave length
```

```

22  Gt=4;
23  Gr=4;
24  C=3e8;
25  f=2.4e9;
26  l=C/f;
27  % Packet length(s)
28  Lp=L;
29  tp=Lp/Datarate;
30
31  for i=1:N
32
33  time=randperm(8);
34  s(i)=time(1);
35  s(i)=s(i)*10^(-3);
36  h=3.8*10^(-3);
37
38  if s(i)<h
39      fprintf('Sensor in active interval')
40
41  r(i)=sqrt((bs_x -sensor_x(i))^2+ (bs_y - sensor_y(i))^2 +...
42      (bs_z - sensor_z(i))^2);
43
44  tt(i)=tp;
45  tr_PAN(i)=s(i)+tp;
46  pt(i)=p_max*tp/900 ;
47  prr=(pt(i)*(l)^2);
48  pr=(prr*Gt*Gr)/(r(i))^(2.5);
49  pr_PAN(i)=pr/((4*pi)^2);
50
51  if pr_PAN<Rs
52      fprintf('signal PAN is very low');
53  end
54
55  P_PAN=((pr_PAN(i))*tr_PAN(i))/900;
56  P_chip(i)=(v*It*tt(i));
57  else
58  %fprintf('Sensor in sleep interval')
59  td(i)=rand*10^(-3);
60  ti(i)=tp+td(i);
61  time=randperm(8);
62  s(i)=time(1);
63  s(i)=s(i)*10^(-3);
64
65  while s(i)>=h
66

```

```

67         fprintf( ' sleep mode')
68     td2=rand*10^(-3);
69     ti(i)=ti(i)+td2;
70     time=randperm(8);
71     s(i)=time(1);
72     s(i)=s(i)*10^(-3);
73     end
74     fprintf('send packet')
75     r(i)=sqrt((bs_x -sensor_x(i))^2+...
76         (bs_y - sensor_y(i))^2 +(bs_z - sensor_z(i))^2)
77     tt(i)=2*tp;
78     tr_PAN(i)=s(i)+tp;
79     pt(i)=(2*p_max*tp)/900 ;
80     prr=pt(i)*((l)^2);
81     pr=(prr*Gt*Gr)/(r(i))^(2.5);
82     pr_PAN(i)=pr/((4*pi)^2);
83
84     if pr_PAN<Rs
85         fprintf('signal is very low');
86     end
87     P_chip(i)= ((v*It*tt(i))+(PI*ti(i)));
88
89     end
90     P_avreage_chip=mean(P_chip);
91     P_chip_P(i)= (v*Ir*tr_PAN(i));
92     P_chip_PAN=mean(P_chip_P);
93     end
94     P_chip_network =P_avreage_chip+ P_chip_PAN
95     for k=1:N-1
96
97         rb(k)=sqrt((sensor_x(k+1) -sensor_x(k))^2+...
98             (sensor_y(k+1) -
99             sensor_y(k))^2+(sensor_z(k+1) - sensor_z(k))^2);
100
101     end
102
103 end

```

```

1 function [Test]=test_star(L,N,v,Datarate,Itt,sens)
2 fprintf(' Test Satr')
3 sensor_x=[1 10 15 20 25];
4 sensor_y=[0 0 0 0 0];
5 sensor_z=[0 0 2 0 0];
6 % The PAN position

```

```

7  bs_x=[0];
8  bs_y=[0];
9  bs_z=[5];
10 % Current consumption for cc2420
11 % In different radio modes
12 It=Itt*10(-3);
13 Ir=19.7*10(-3);
14 Ii=396*10(-6);
15 % Receiver sensitivity
16 Rs=(10(sens/10))/1000;
17 p_max=v*It;
18 PI= v*Ii;
19 % Antenna gain and wave length
20 Gt=4;
21 Gr=4;
22 C=3e8;
23 f=2.4e9;
24 l=C/f;
25 % Packet length(s)
26 Lp=L;
27 tp=Lp/Datarate;
28
29 for i=1:N
30
31     %fprintf('All sensors in active mode')
32
33     r(i)=sqrt((bs_x -sensor_x(i))^2+ (bs_y - sensor_y(i))^2 +...
34             (bs_z - sensor_z(i))^2);
35
36     tt(i)=tp;
37     tr_PAN(i)=tp;
38     pt(i)=p_max*tp/900;
39     prr=pt(i)*((l)^2);
40     pr=(prr*Gt*Gr)/(r(i))(2.5);
41     pr_PAN(i)=pr/((4*pi)^2);
42     P_chip(i)=(v*It*tt(i));
43     P_PAN_chip=(v*Ir*tr_PAN(i));
44
45 end
46 P_avreage_PAN=mean(P_PAN_chip);
47 P_chip_network_Min= (P_PAN_chip+ P_avreage_PAN) ;
48
49 for i=1:N
50
51     % fprintf(' All sensors in sleep mode')

```

```

52
53 r(i)=sqrt((bs_x -sensor_x(i))^2+ (bs_y - sensor_y(i))^2 +...
54         (bs_z - sensor_z(i))^2);
55
56 ti(i)=tp+(10^(-2));
57 tt(i)=2*tp;
58 tr_PAN(i)=tp;
59 pt(i)=(2*p_max*tp)/900;
60 prr=pt(i)*((l)^2);
61 pr=(prr*Gt*Gr)/(r(i))^(2.5);
62 pr_PAN(i)=pr/((4*pi)^2);
63 P_chip(i)=(v*It*tt(i))+(v*Ii*ti(i));
64 P_PAN_chip=(v*Ir*tr_PAN(i));
65
66 end
67 P_avreage_chip=mean(P_chip);
68 P_avreage_PAN=mean(P_PAN_chip);
69 P_chip_network_Max=(P_avreage_chip+ P_avreage_PAN);
70 Out=Star_power(L,N,v,Datarate,Itt,sens)
71 p_min=P_chip_network_Min
72 p_max=P_chip_network_Max
73
74 if ( p_min ≤ Out && Out ≤ p_max)
75
76     fprintf('Correct')
77
78     Test=1;
79 else
80     fprintf('Fail')
81     Test=0
82 end
83
84 end

```

```

1
2 function p=run_star(L,N,v,Datarate,Itt,sens);
3 L=L;
4 N=N;
5 v=v;
6 Datarate=Datarate;
7
8 r(1)=5;
9
10 for j=1:50

```

```

11
12     for i=1:r(j)
13         [Out(i)]=Star_power(L,N,v,Datarate,Itt,sens);
14     end
15
16     p(j)=mean(Out);
17     r(j+1)=r(j)+5;
18     BB(j)=r(j);
19     s(j) = std(p)
20
21
22 end
23
24 figure(1);
25 hold on;
26 title('Mean Power Consumption For 5 Nodes In Star');
27 xlabel('The Number Of Runs');
28 ylabel('Standard Deviation');
29
30 plot(BB,p,'-ro');
31 hold off;
32
33 figure(2);
34 hold on;
35 title('Standard deviation In Star');
36 xlabel('The Number Of Runs');
37 ylabel('Standard Deviation');
38
39 plot(BB,s,'-ro');
40 hold off;
41
42
43
44
45 end

```

9.2 Appendix B

9.2.1 CC2400

Application:Game controllers, Sports and leisure equipment, Wireless audio, PC peripherals and Advanced toys.

The CC2400 is mainly designed for low cost and low power wireless applications. It support packet handling, data buffering, burst transmissions, data coding and error detection.

The CC2400 is a true single-chip 2.4 GHz RF transceiver designed for low-power and low-voltage wireless applications. The RF transceiver is integrated with a baseband modem supporting data rates up to 1 Mbps. The CC2400 is a low-cost, highly integrated solution enabling robust wireless communication in the 2.4-2.4835 GHz unlicensed ISM band. It is intended for systems compliant with world-wide regulations covered by EN 300 440 (Europe), CFR47 Part 15 (US) and ARIB STD-T66 (Japan). Targeting a wide range of applications at 2.4 GHz, the CC2400 supports over-the-air data rates of 10 kbps, 250 kbps and 1 Mbps without requiring any modifications to the hardware. The CC2400 provides extensive hardware support for packet handling, data buffering, burst transmissions, data coding and error detection reducing the workload on the host microcontroller. The main operating parameters of CC2400 can be programmed via an SPI-bus. In a typical system CC2400 will be used together with a microcontroller and a few external, passive components. CC2400 is based on Chipcon's SmartRF-03 technology in 0.18 microm CMOS.