

Fast Mobile IP

Learning outcomes:
Introduction to Fast Mobile IP Handover



Fast Mobile IP

- During handover there is a short period the Mobile Node cannot send or receive packets because of link-switching delay and IP protocol operations.
 - Movement detection
 - New Care-of-Address configuration
 - Binding Update
- This is not great if using real-time applications like VoIP or streaming or videochat.

Fast Mobile IP

- This presentation is based on RFC 5568 by IETF (2009)
- RFC 5568 addresses two problems:
 - How to allow a mobile node to send packets as soon as it detects a new subnet link?
 - How to deliver packets to a mobile node as soon as its attachment is detected by the new access router?
- <http://tools.ietf.org/html/rfc5568>

Lets start looking at «slow handover»



Slow Handover

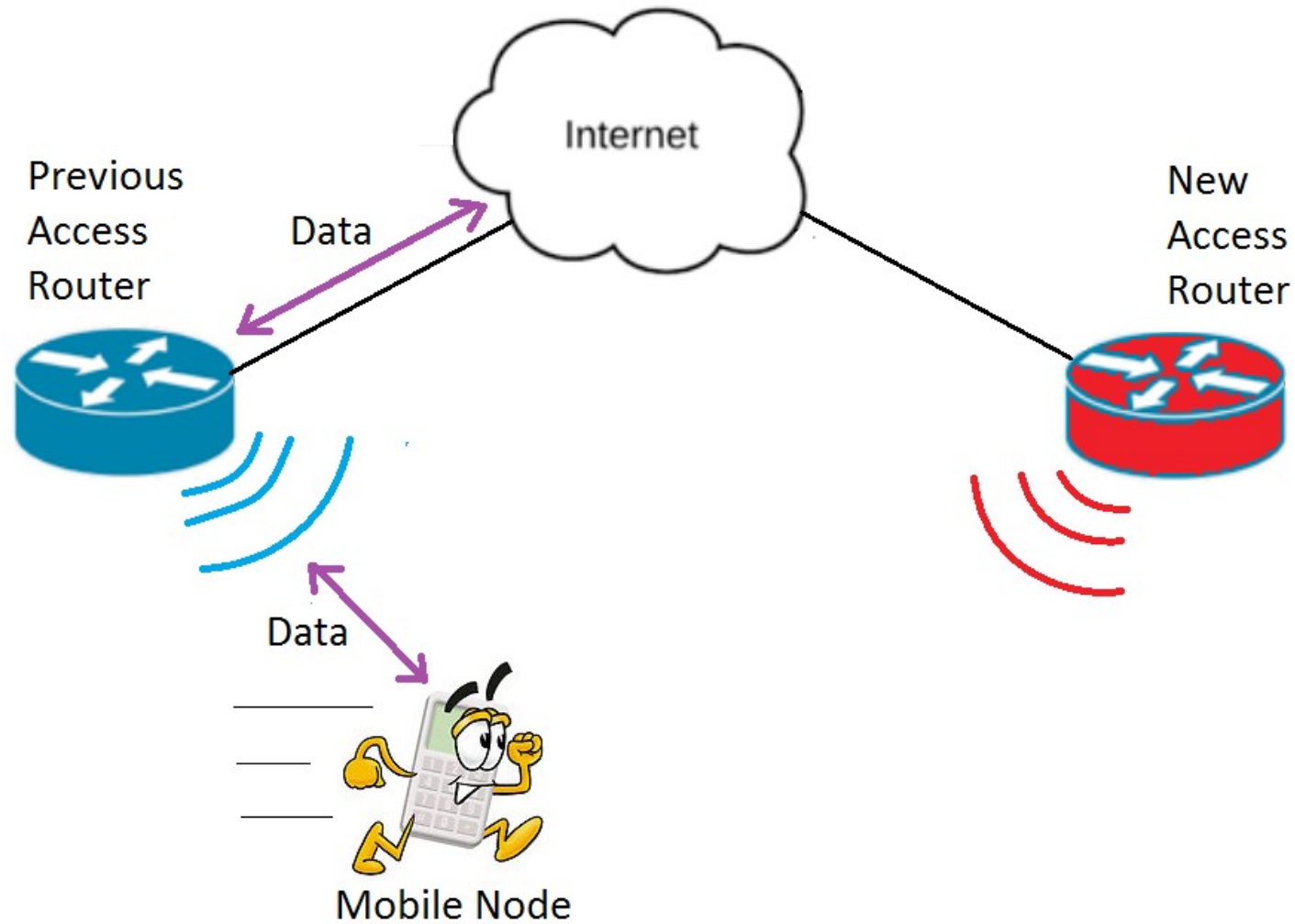

Slow Handover

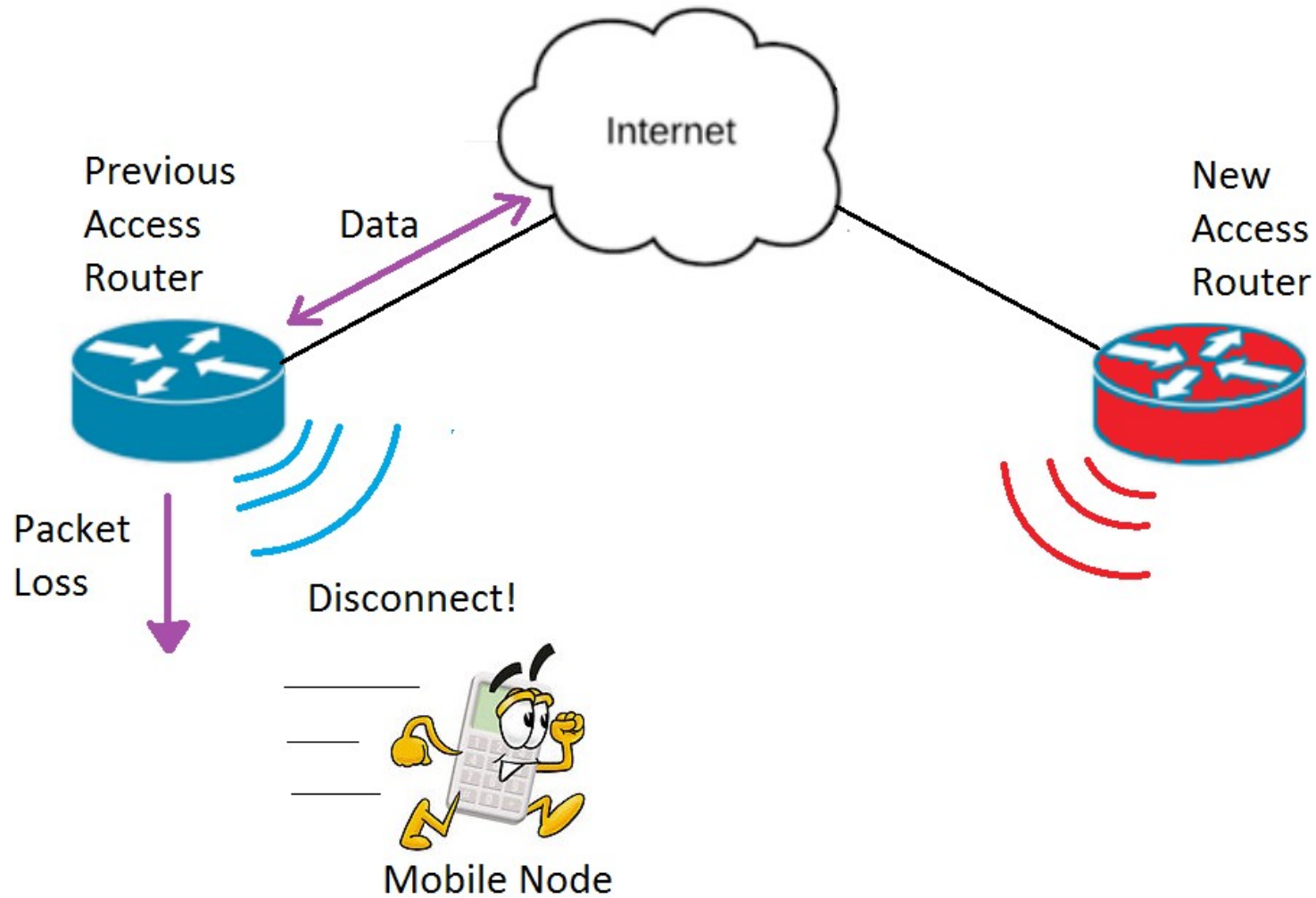

Slow Handover

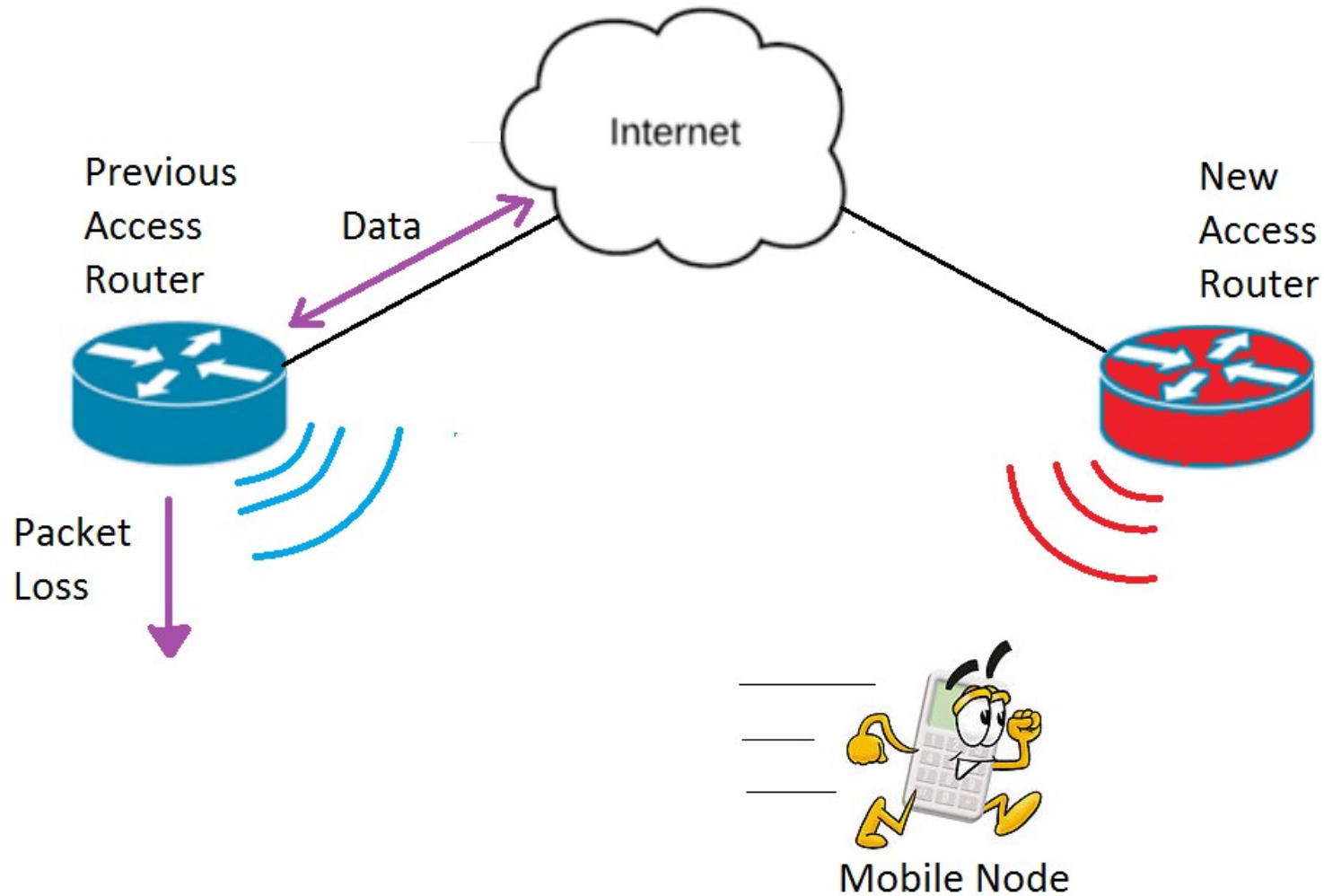

Slow Handover

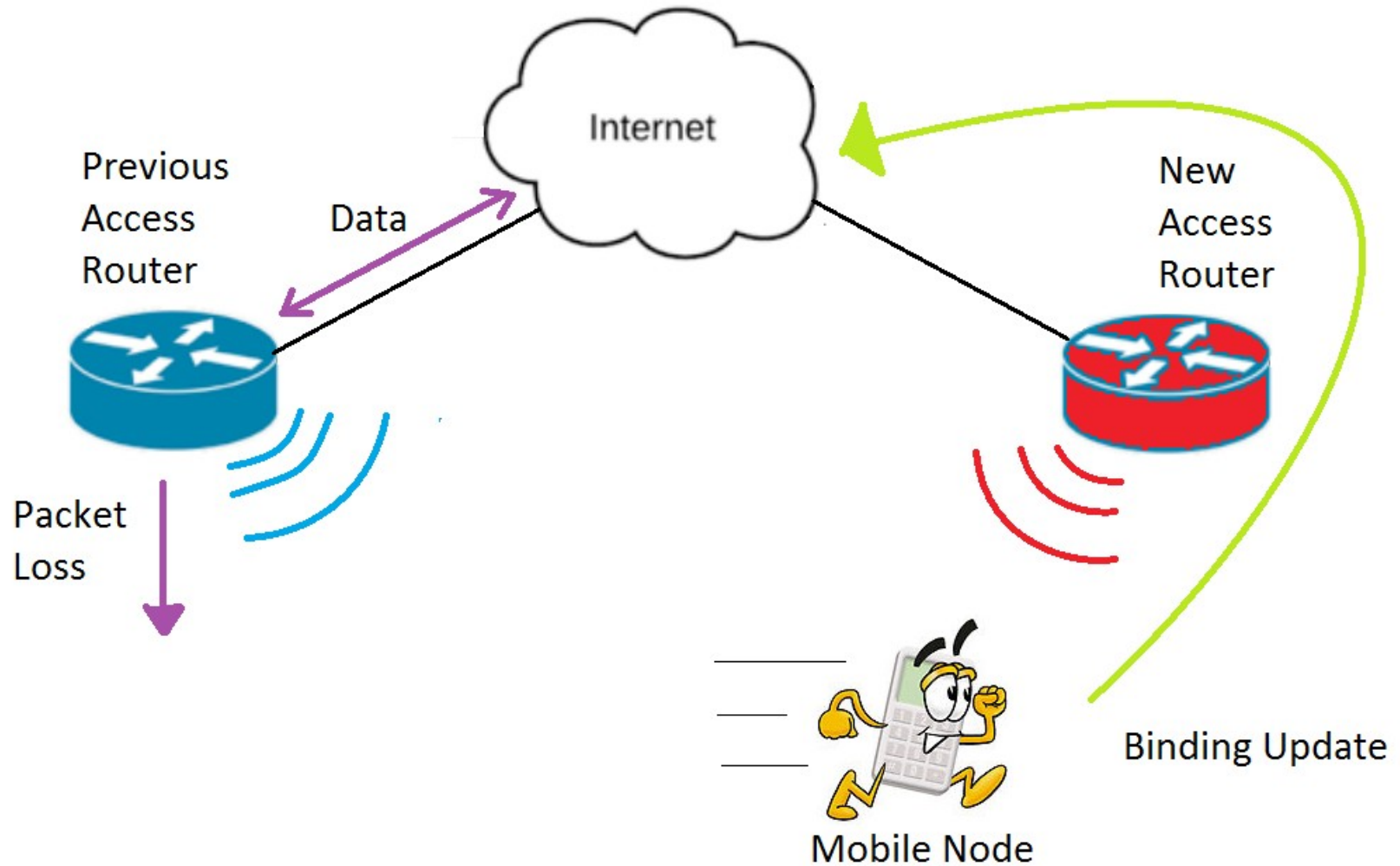

Slow Handover

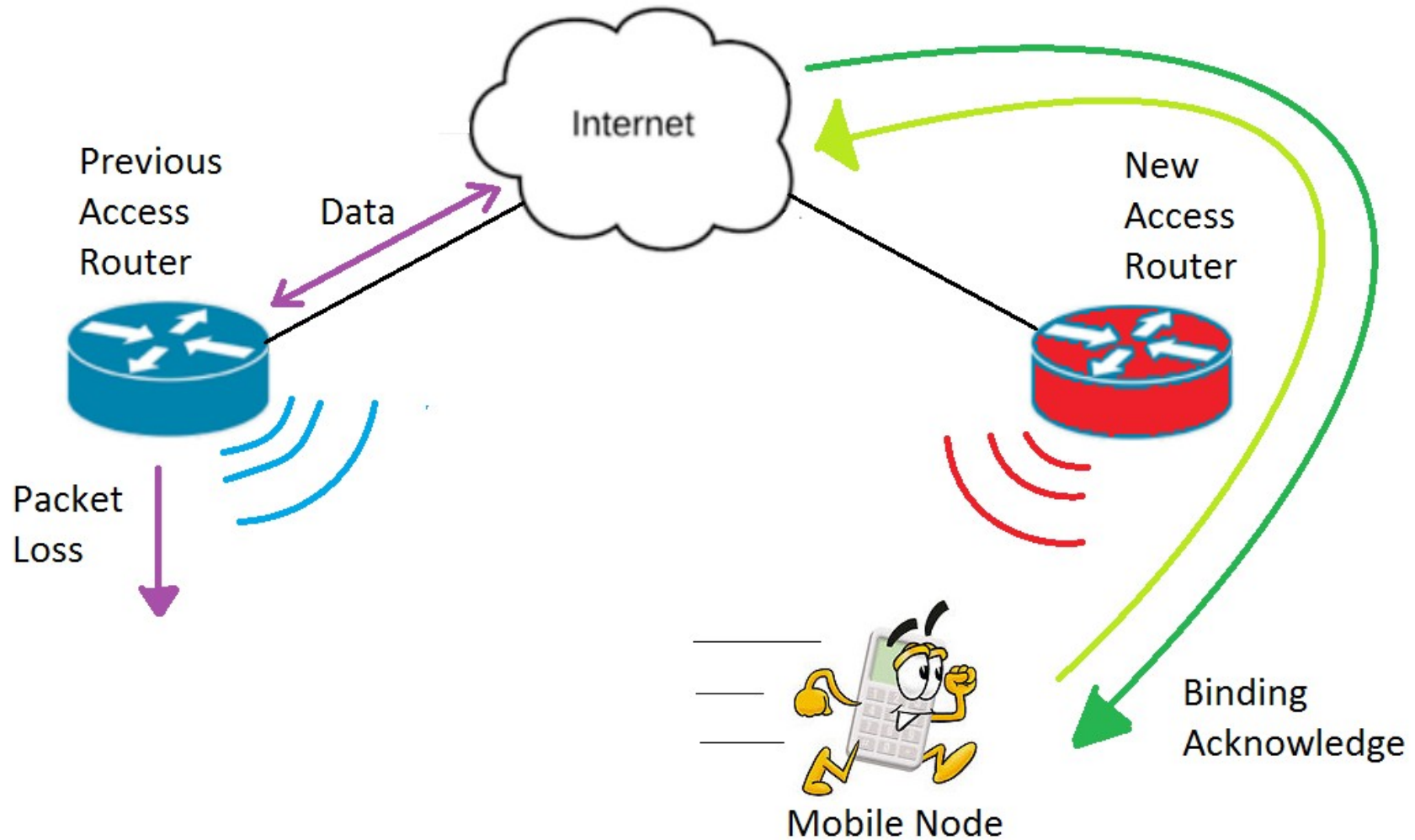

Slow Handover

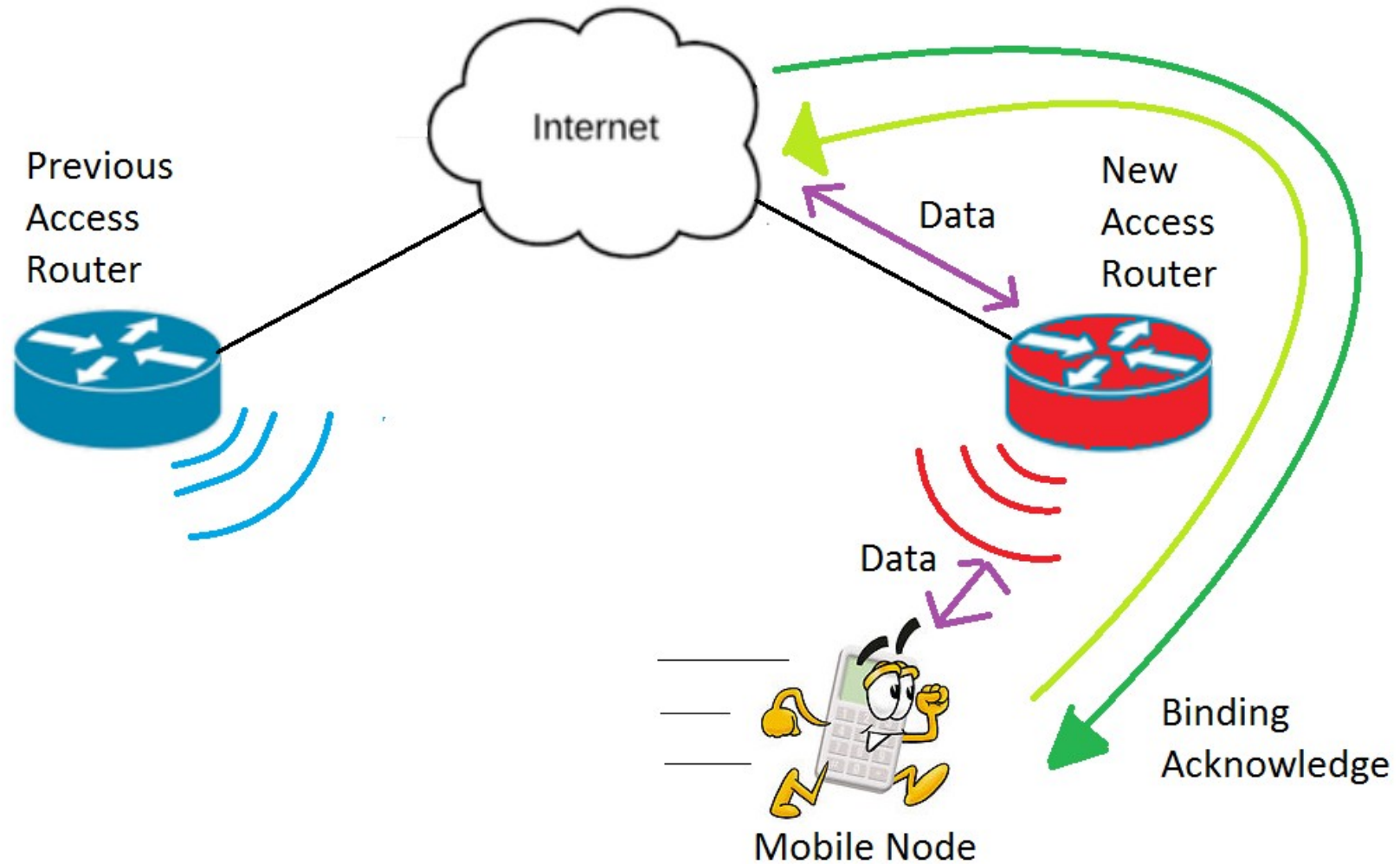

Slow Handover

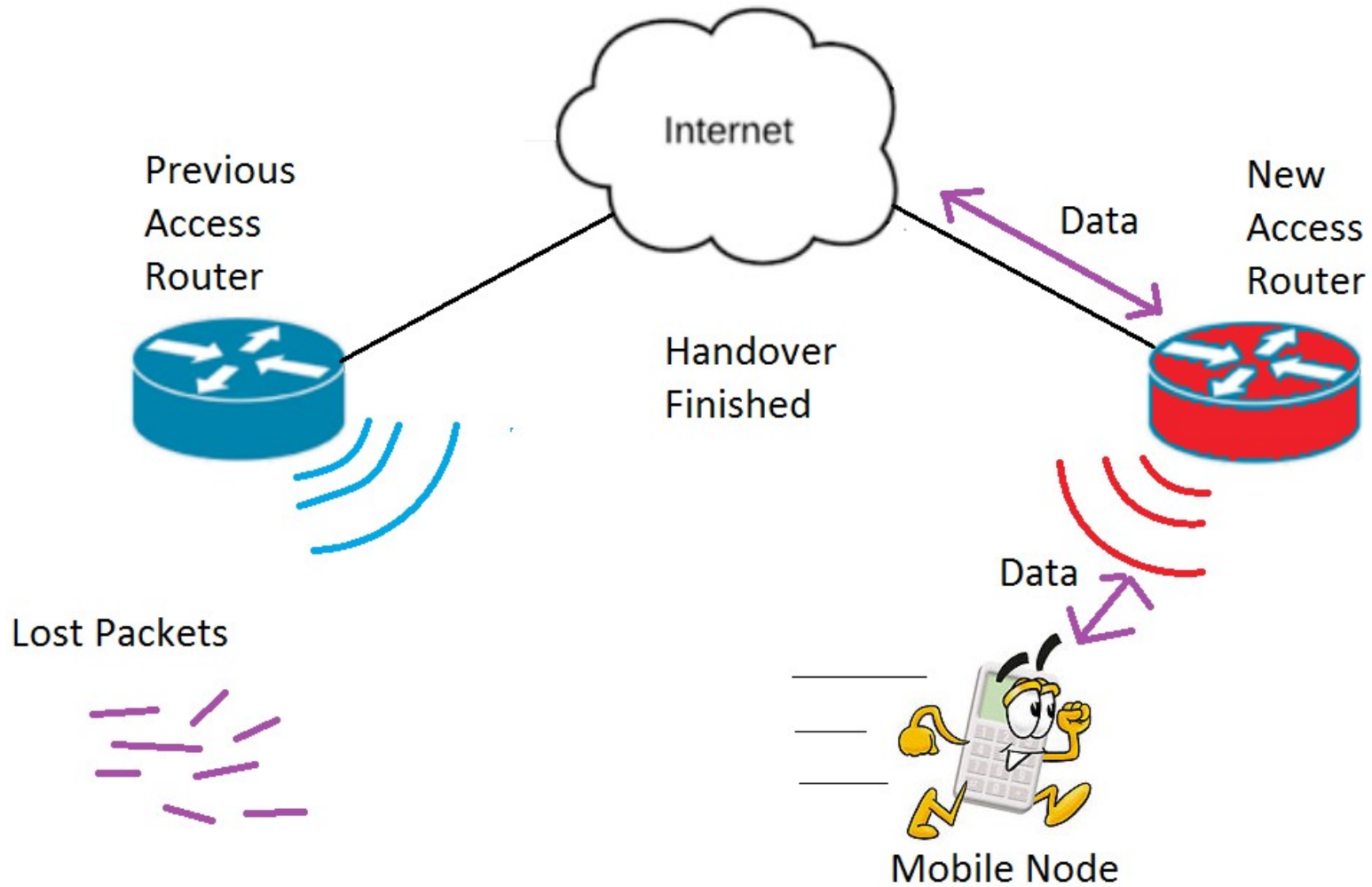

The solution is a tunnel

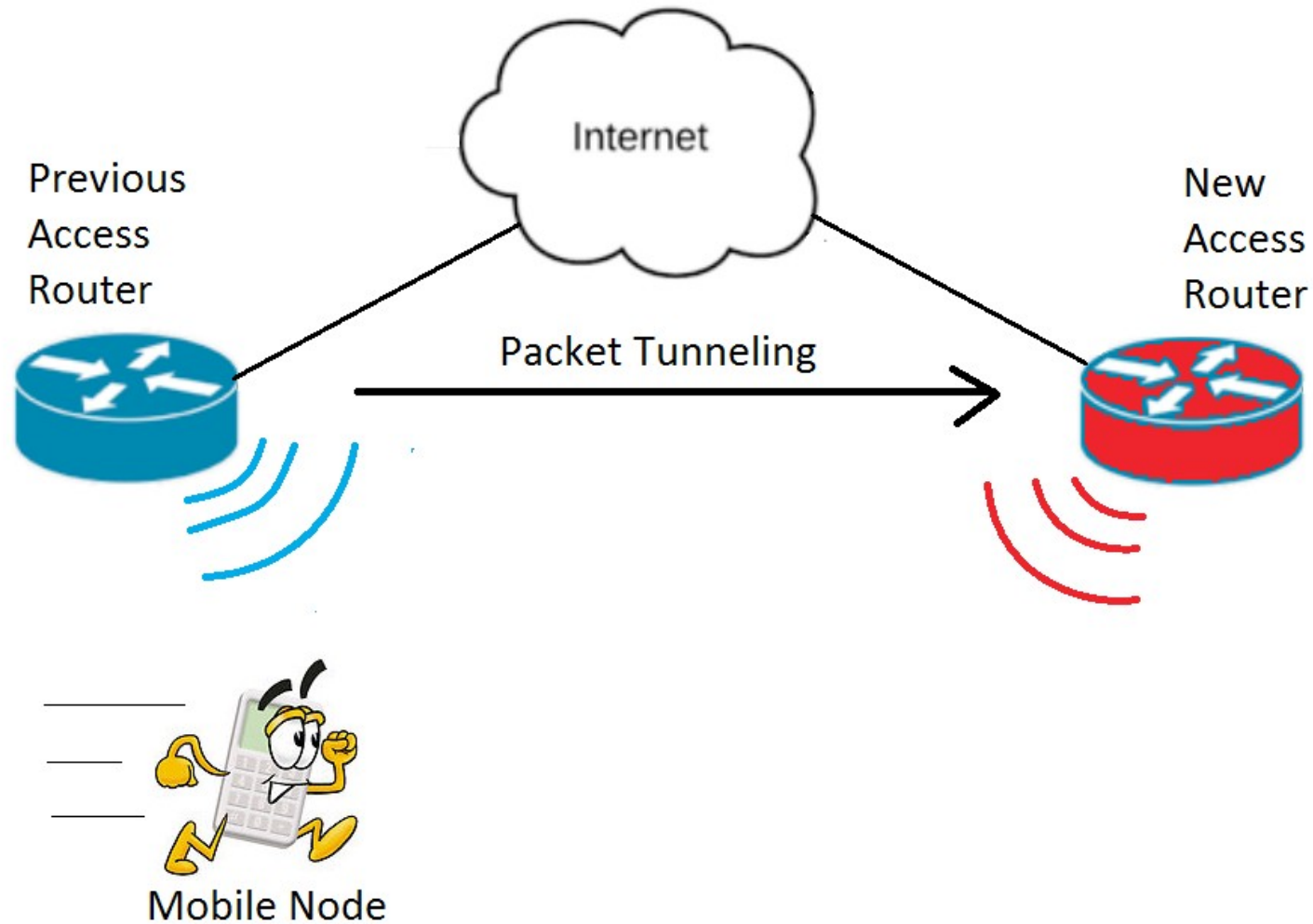

Fast Mobile IP

- Two basic modes of operation:
 - Predictive Fast Handover – Packet tunneling is in progress during handover
 - Reactive Fast Handover – Packet tunneling is NOT in progress during handover
- Lets look at both, starting with the Predictive Fast Handover

Predictive Fast Handover

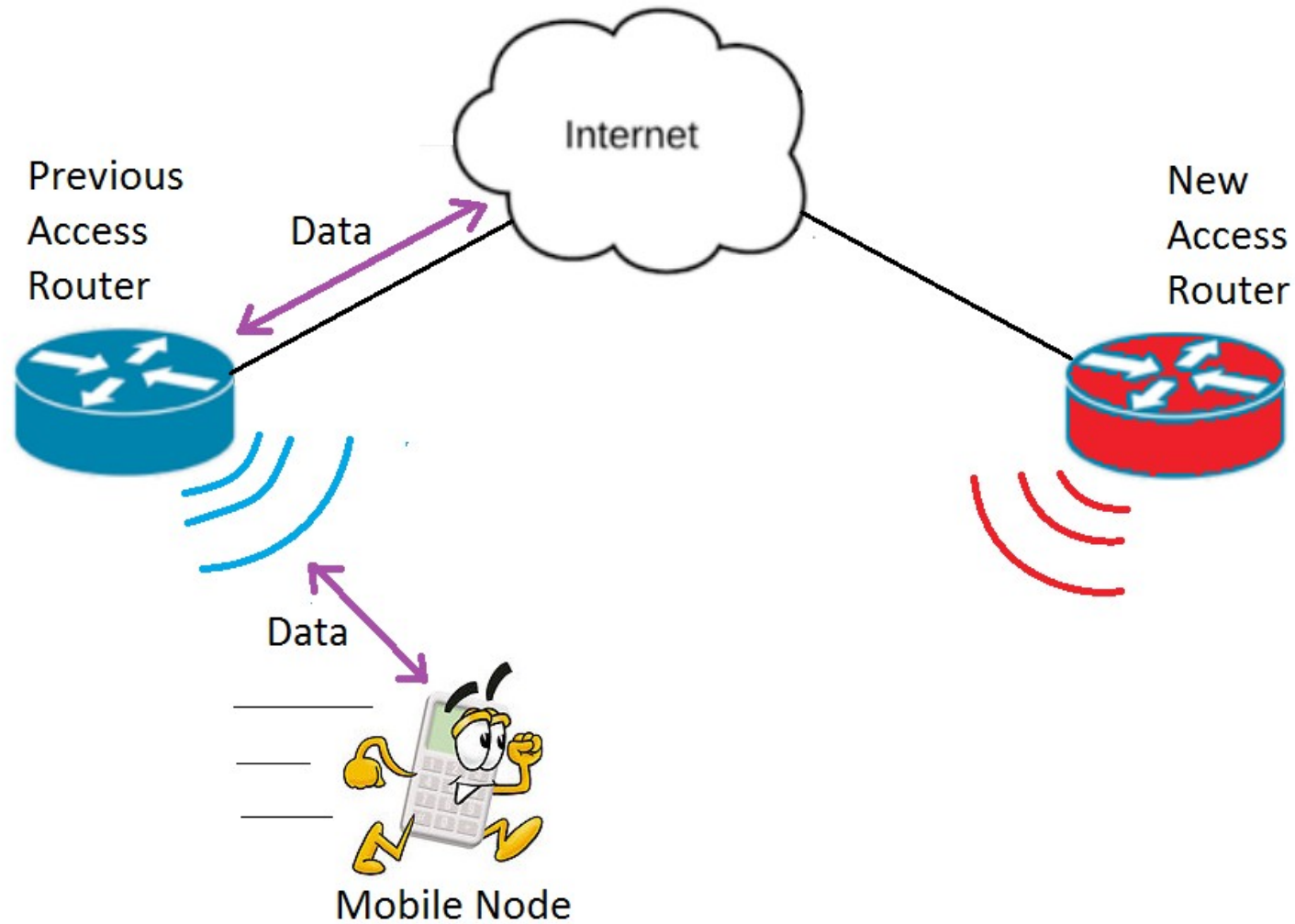

Predictive Fast Handover

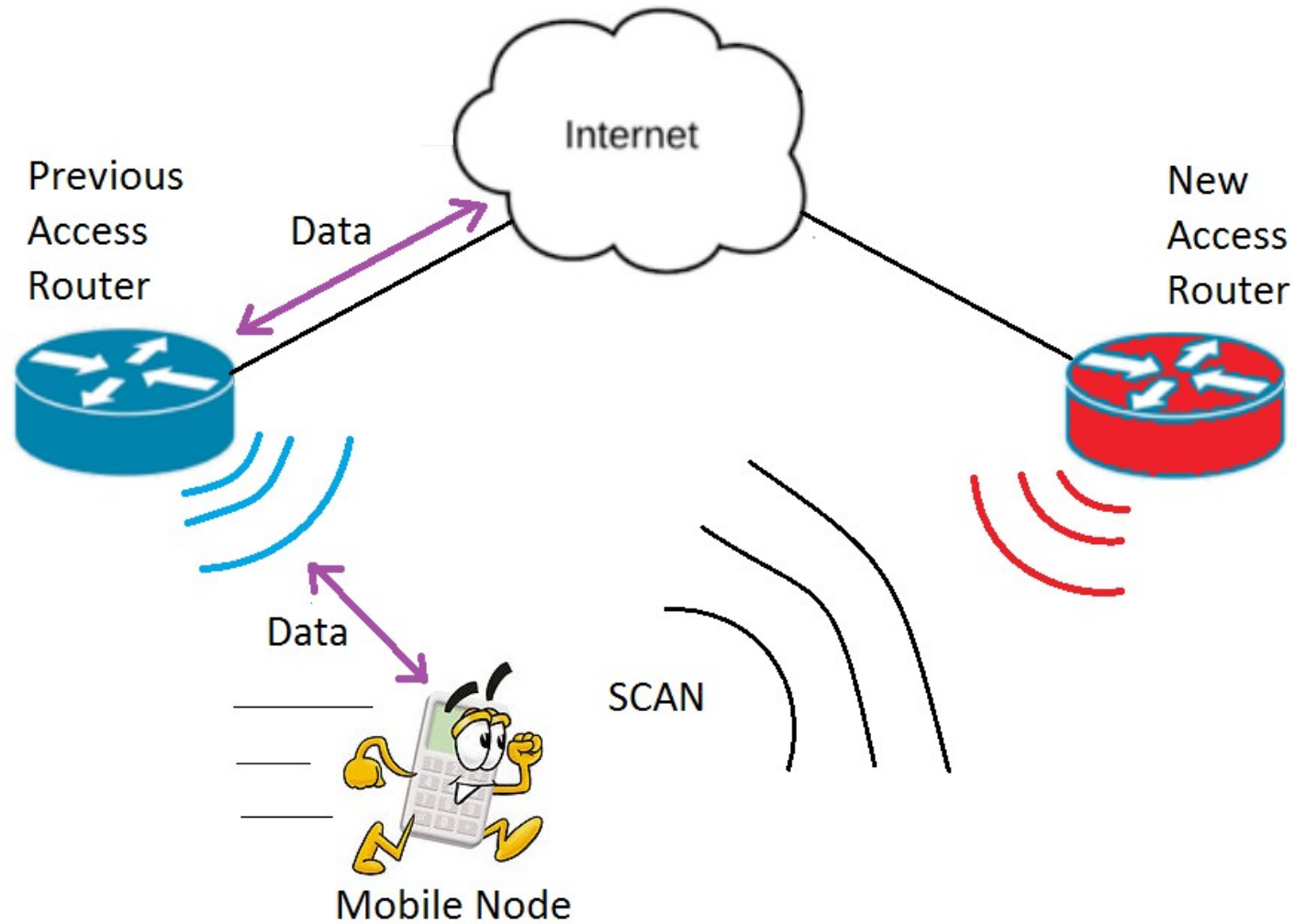

Predictive Fast Handover

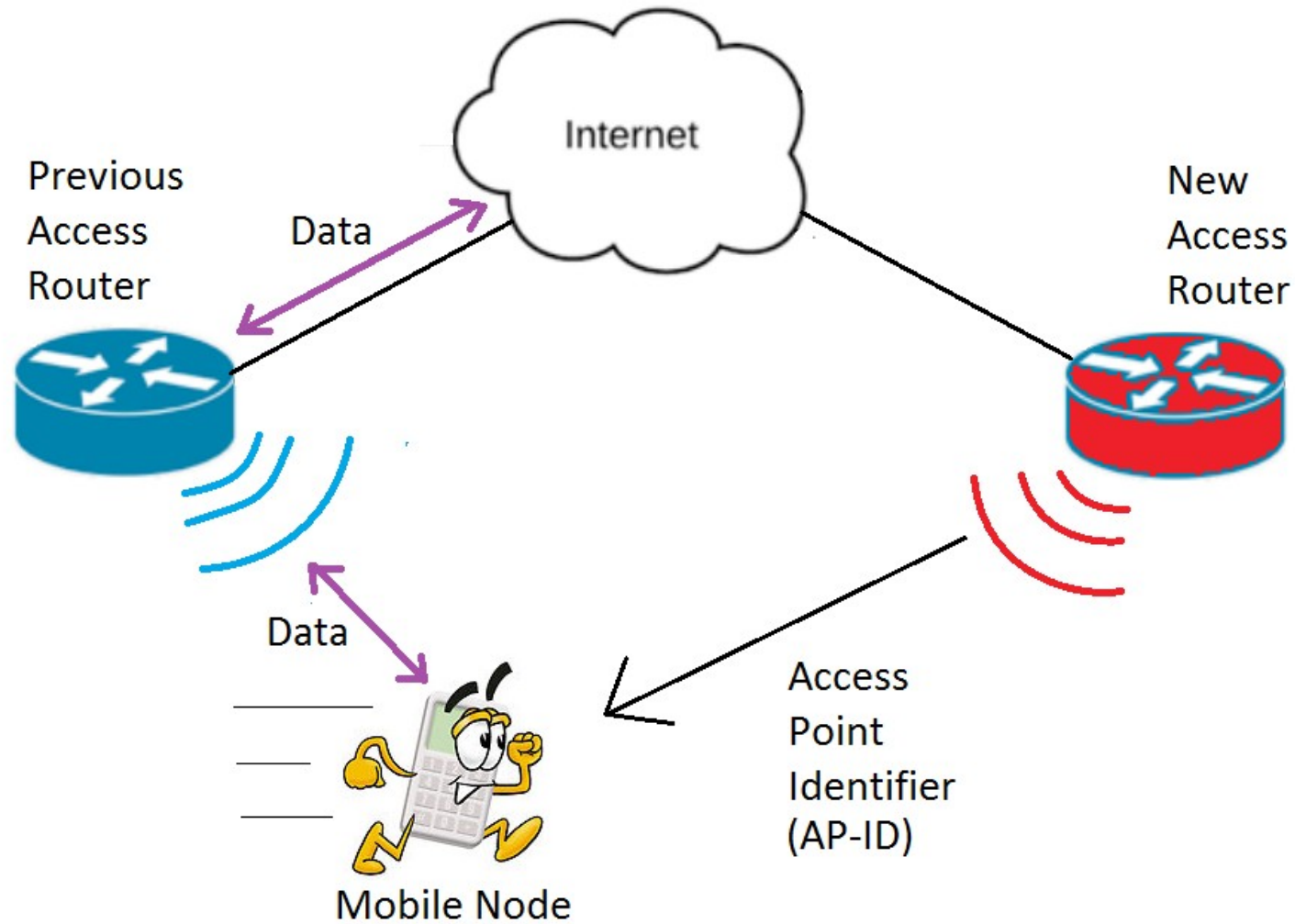

Predictive Fast Handover

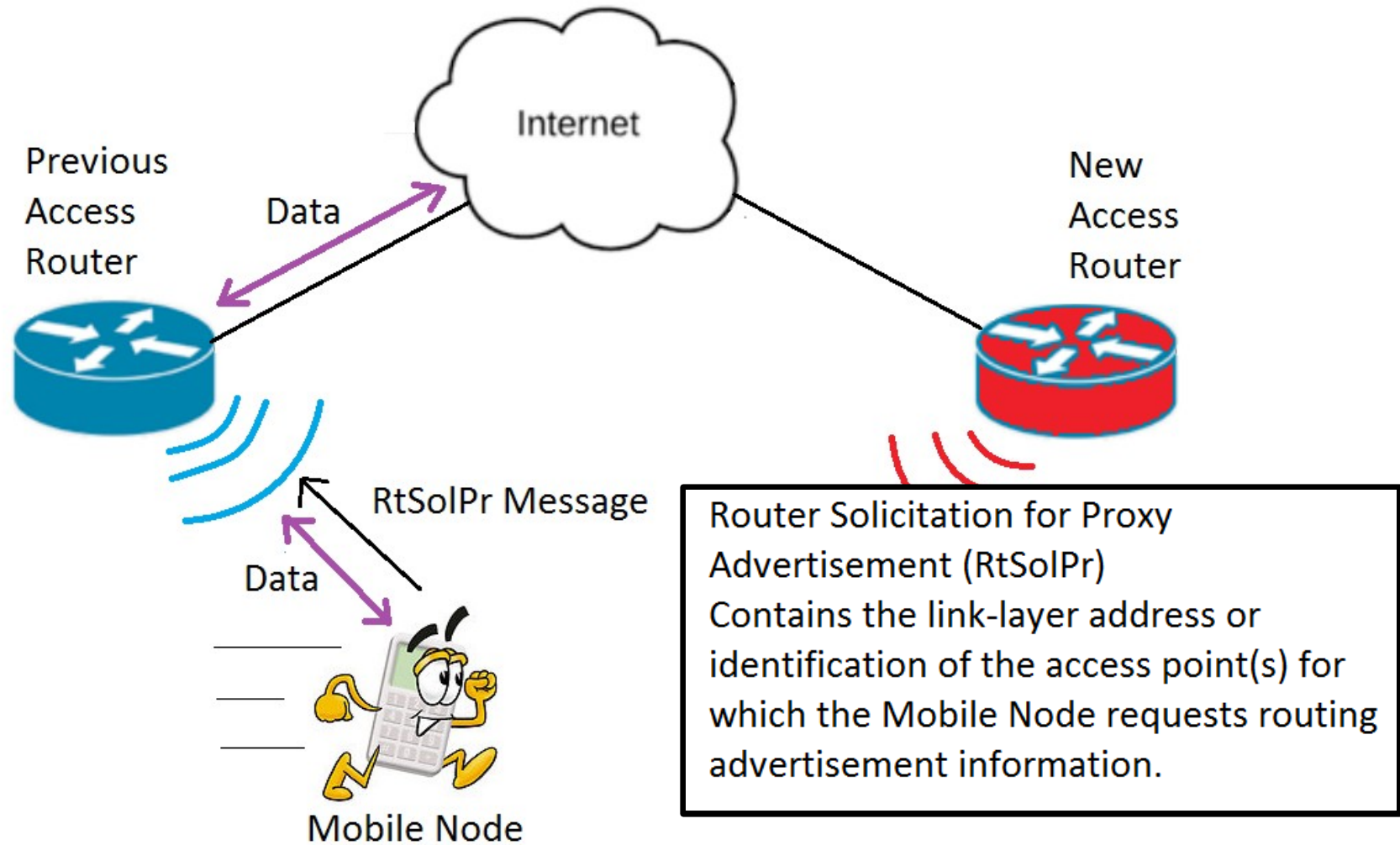

Predictive Fast Handover

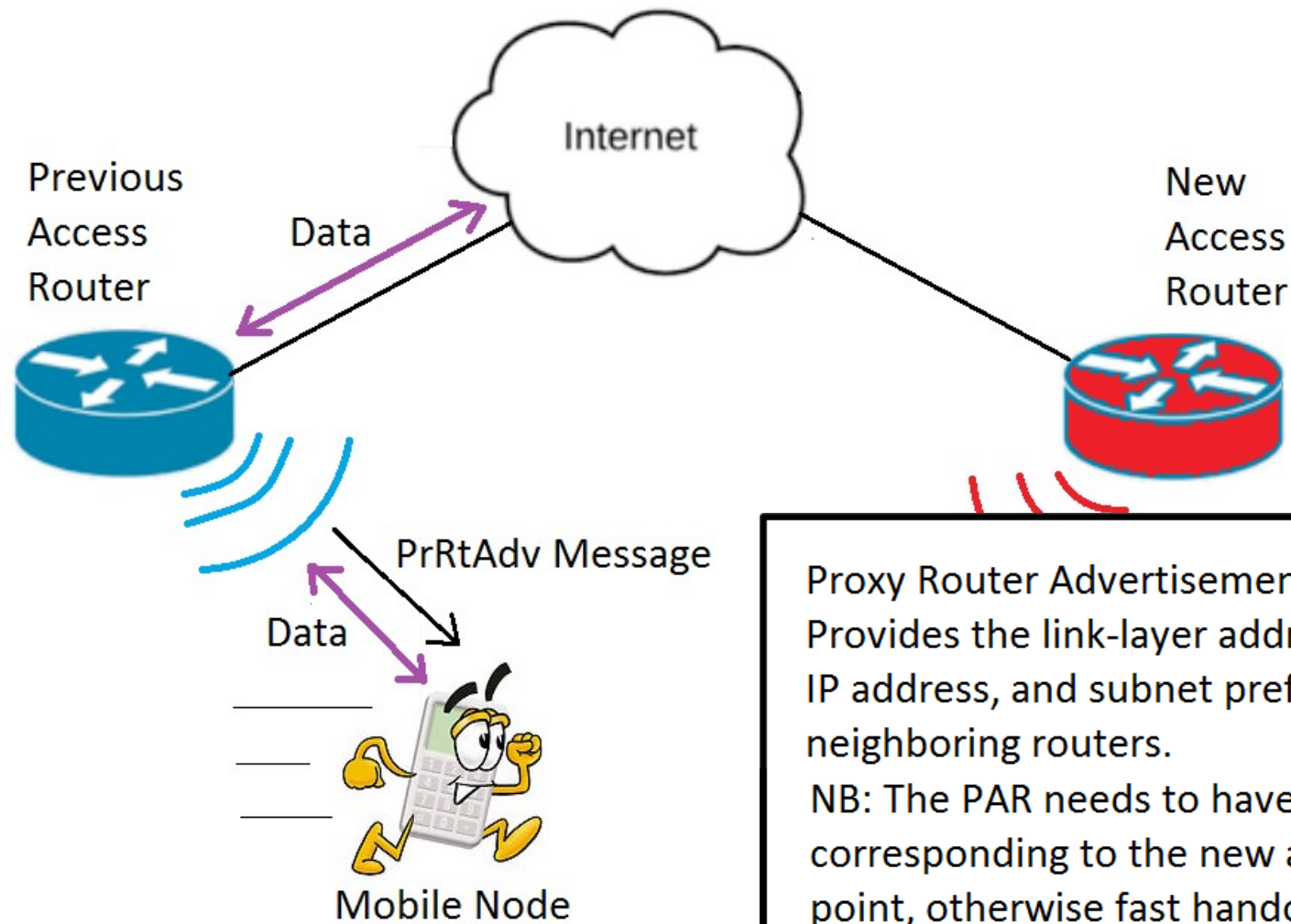

Proxy Router Advertisement (PrRtAdv) Provides the link-layer address, IP address, and subnet prefixes of neighboring routers.

NB: The PAR needs to have an entry corresponding to the new access point, otherwise fast handover stops.

Predictive Fast Handover

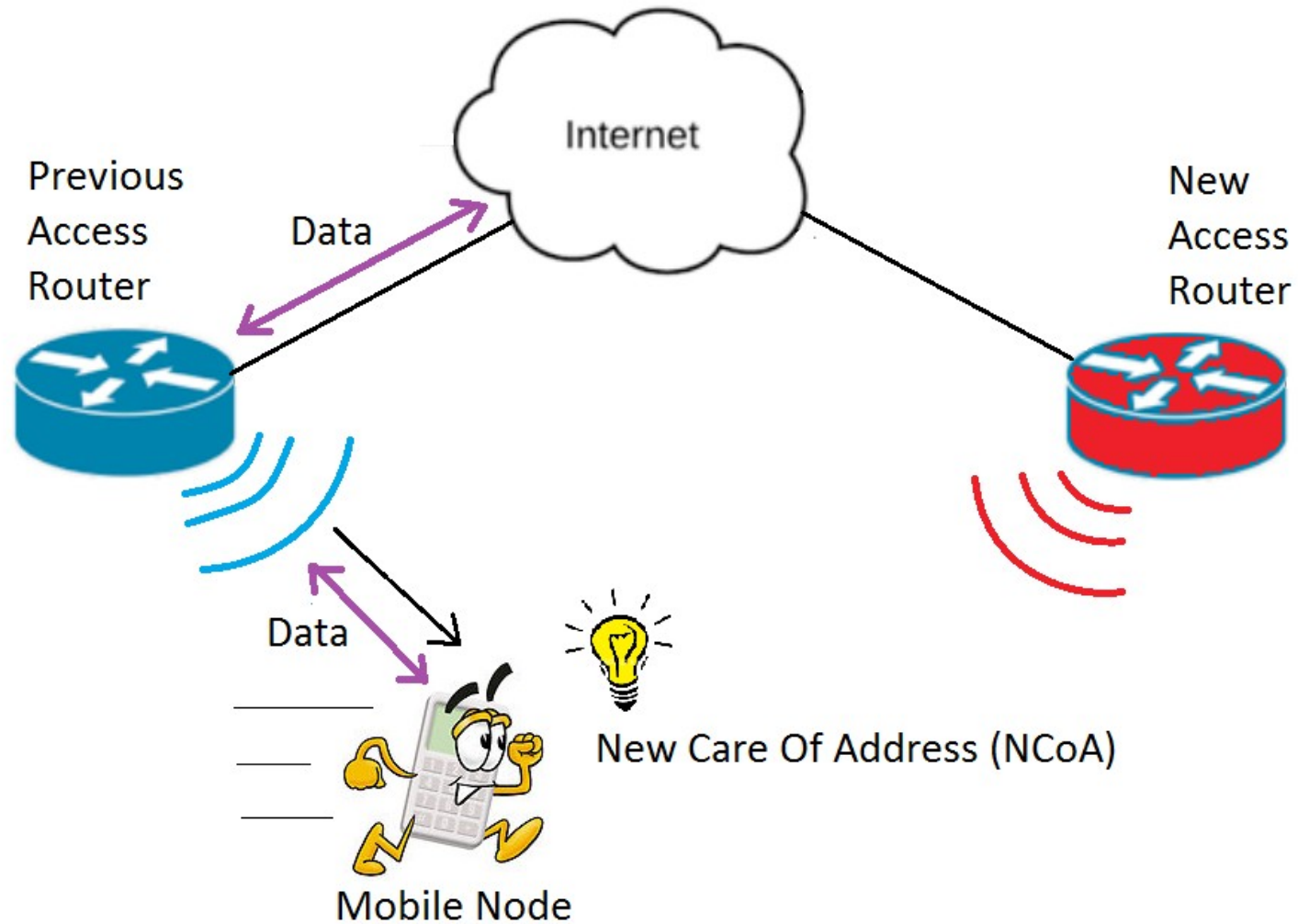

Predictive Fast Handover

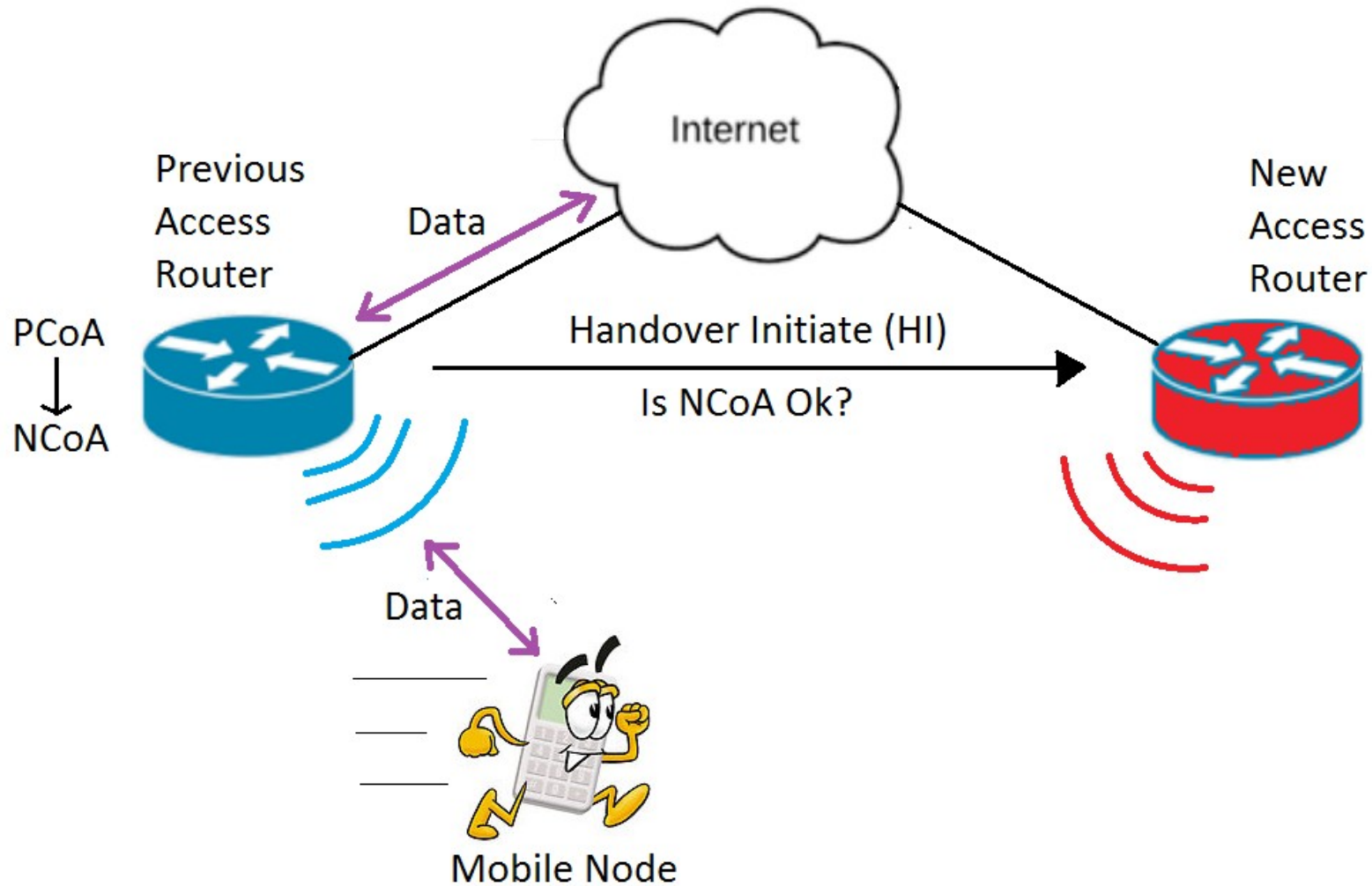

Predictive Fast Handover

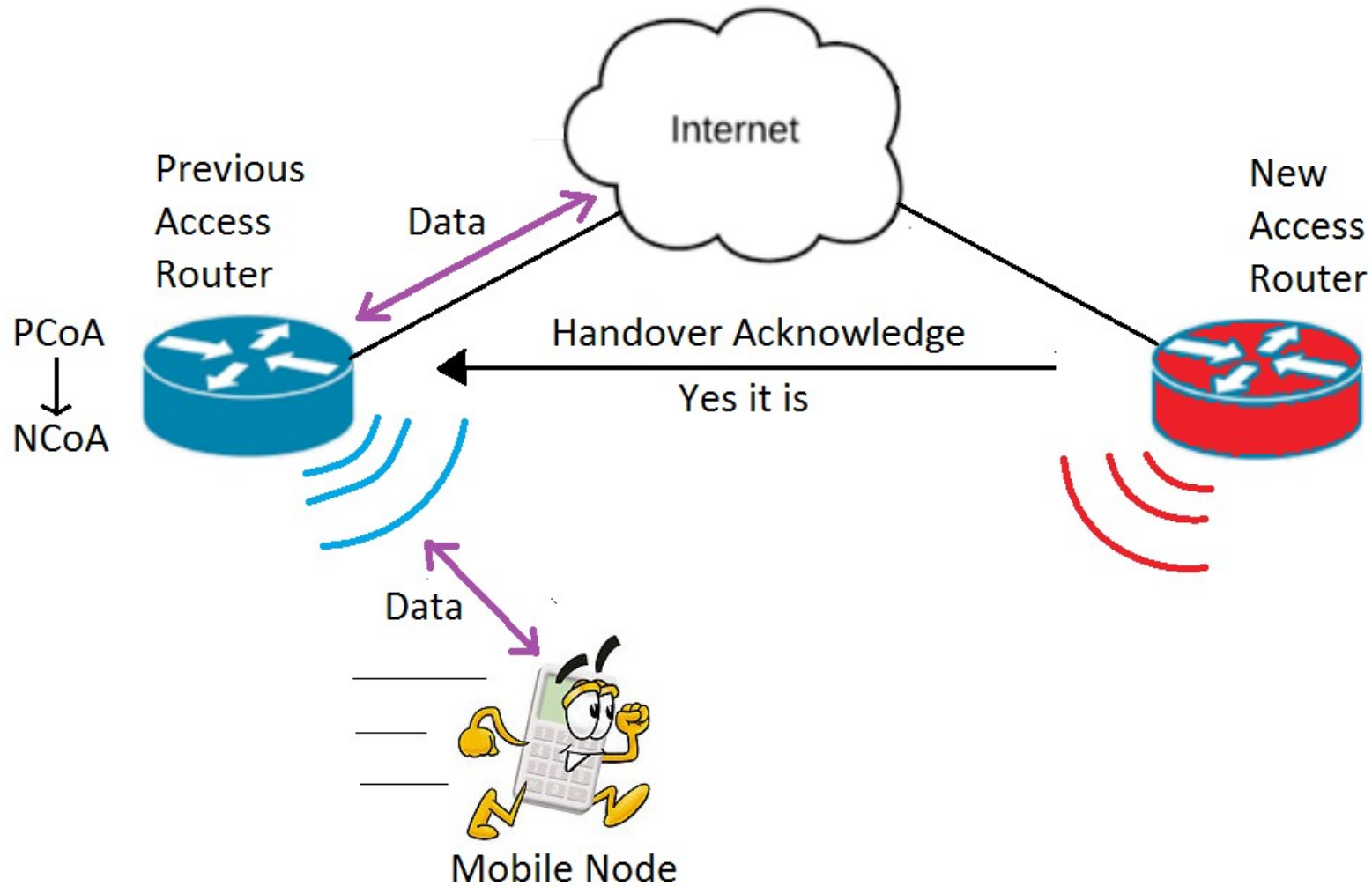

Predictive Fast Handover

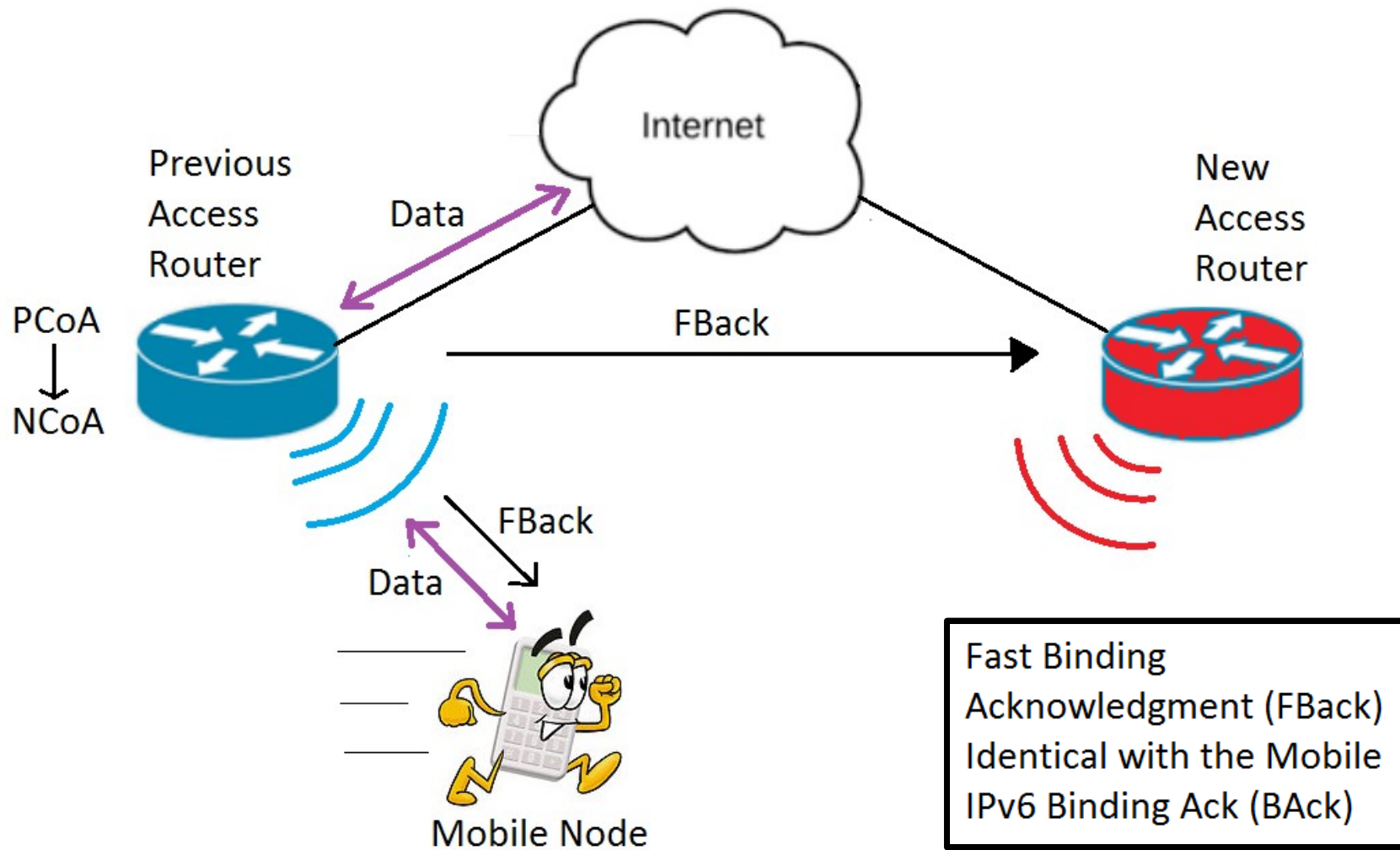

Predictive Fast Handover

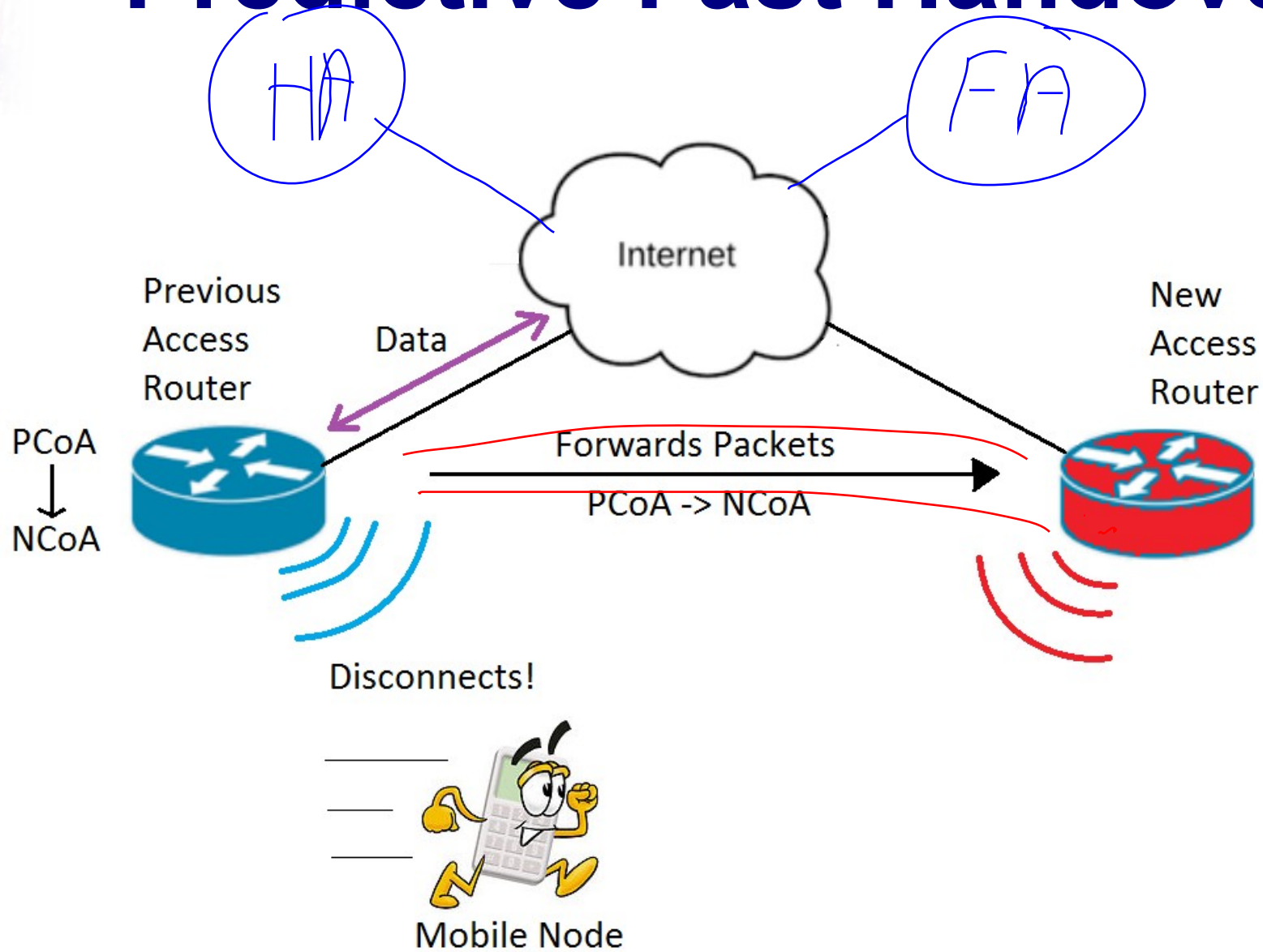

Predictive Fast Handover

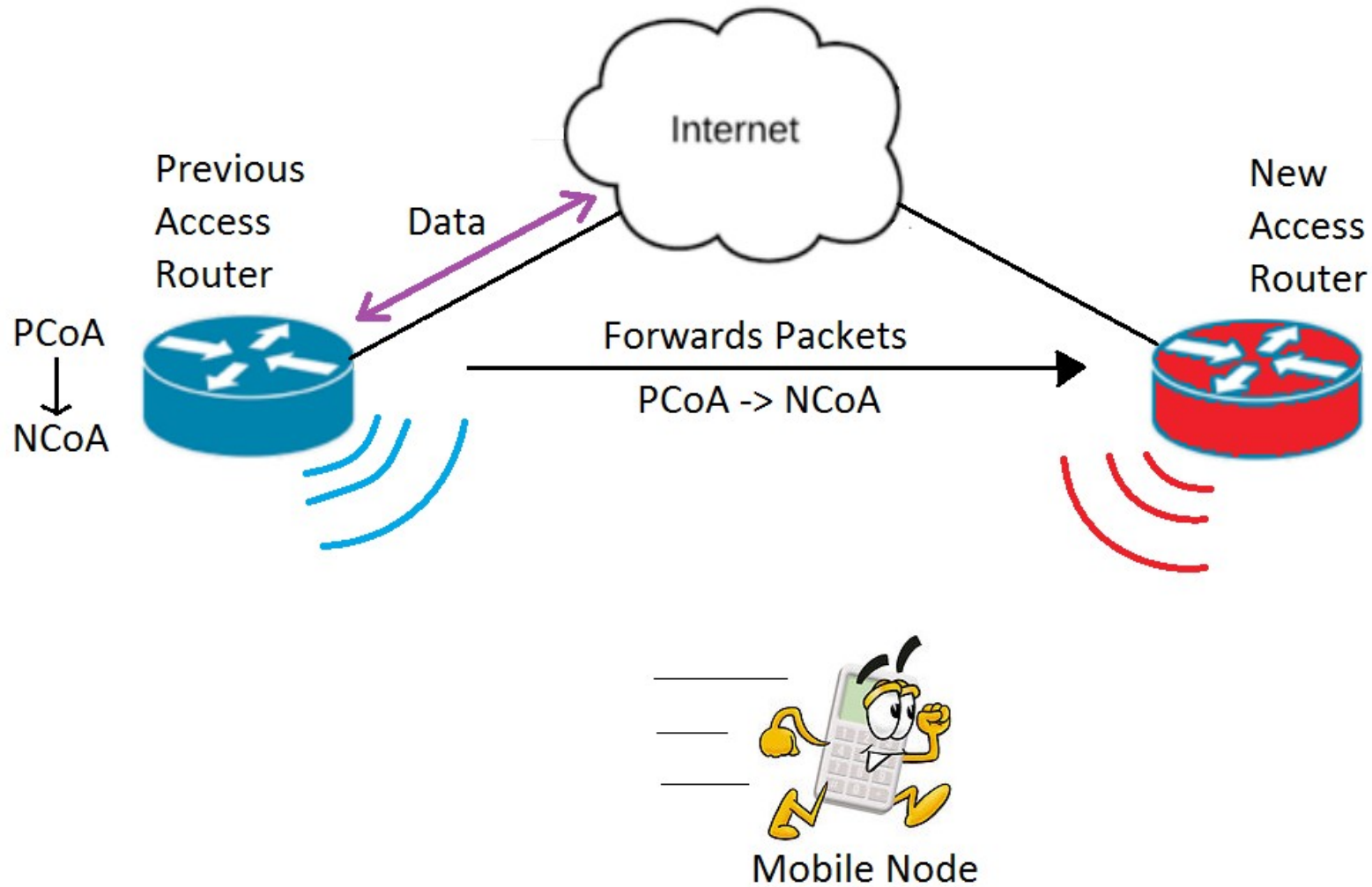

Predictive Fast Handover

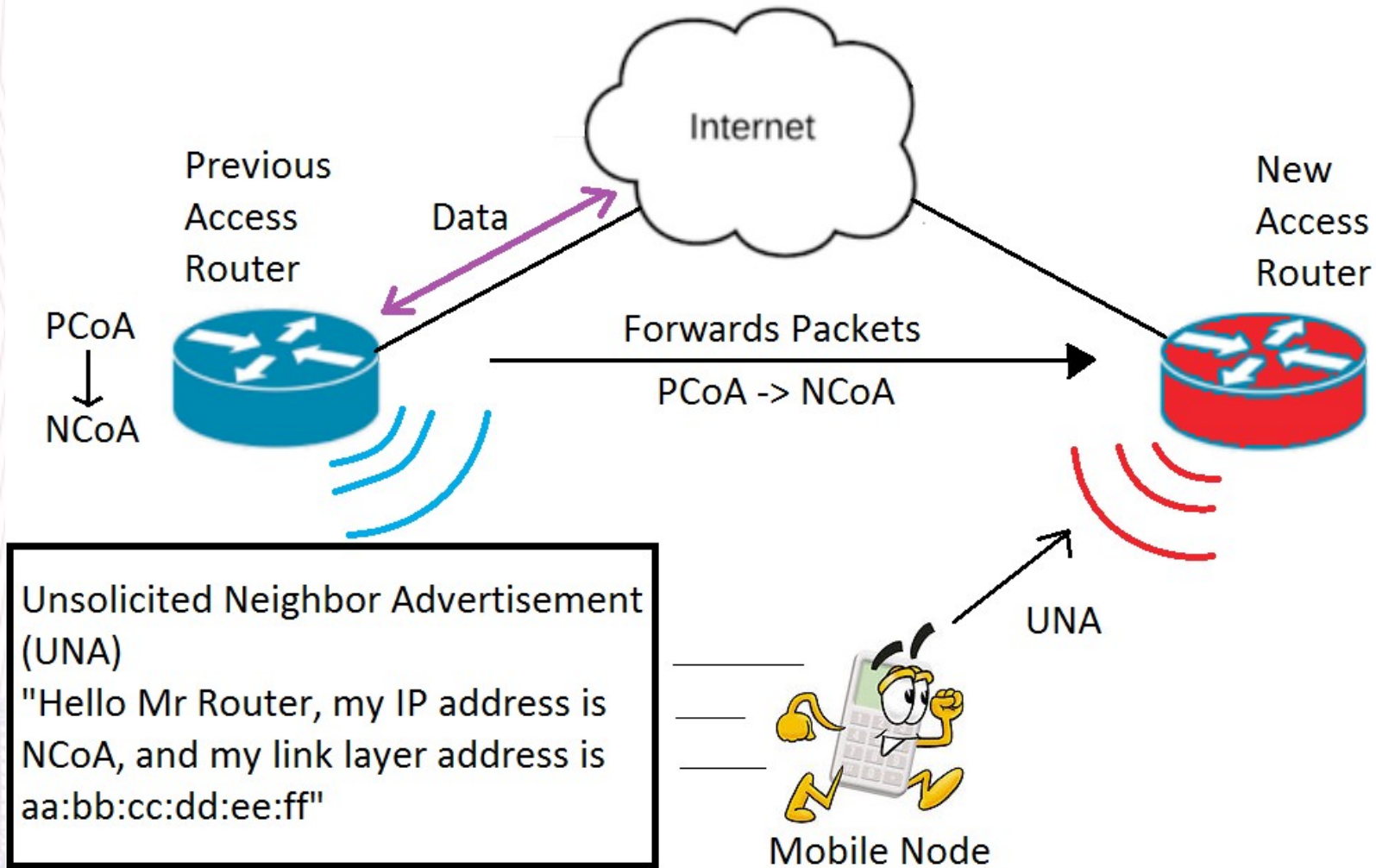

Predictive Fast Handover

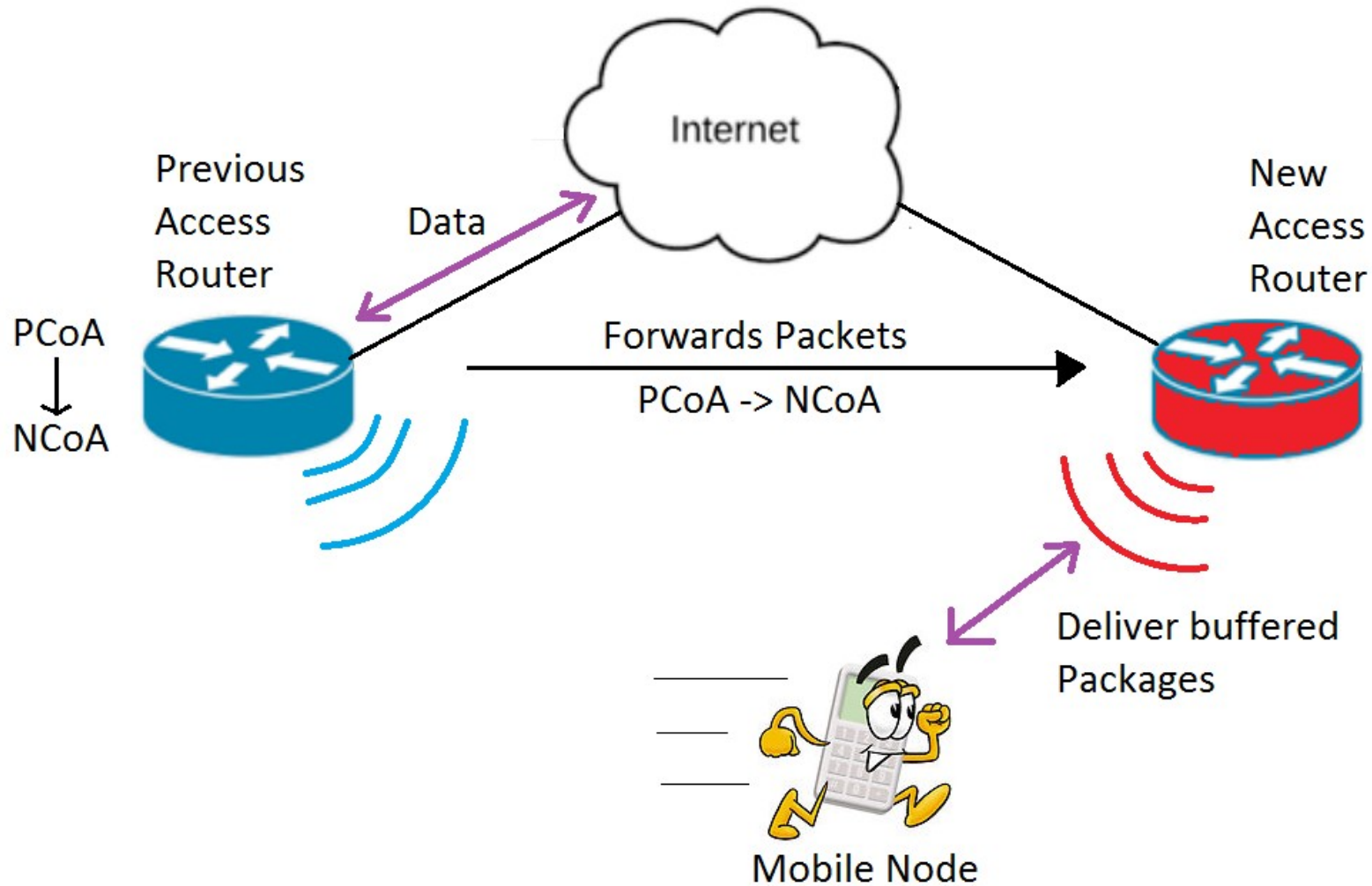

Predictive Fast Handover

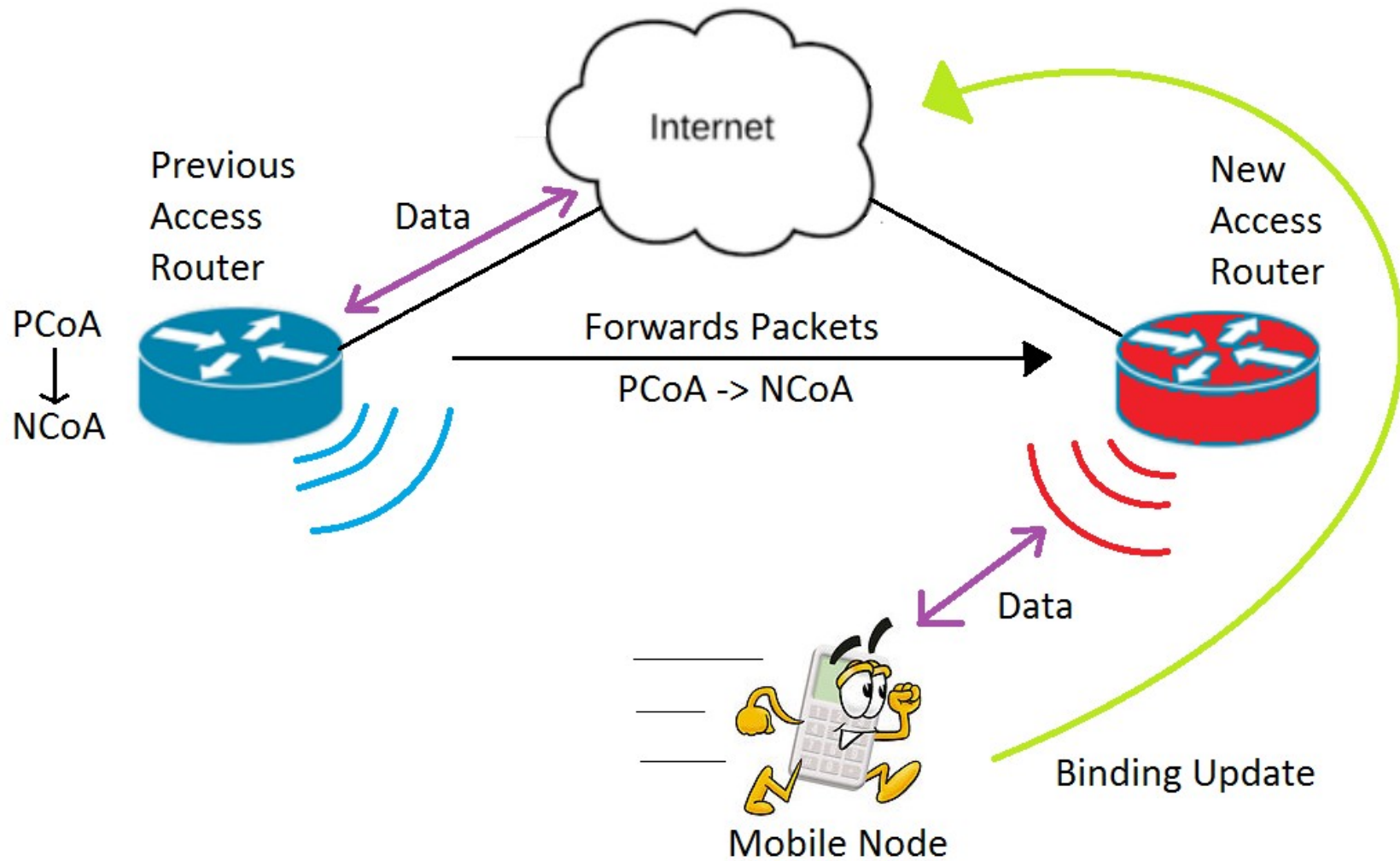

Predictive Fast Handover

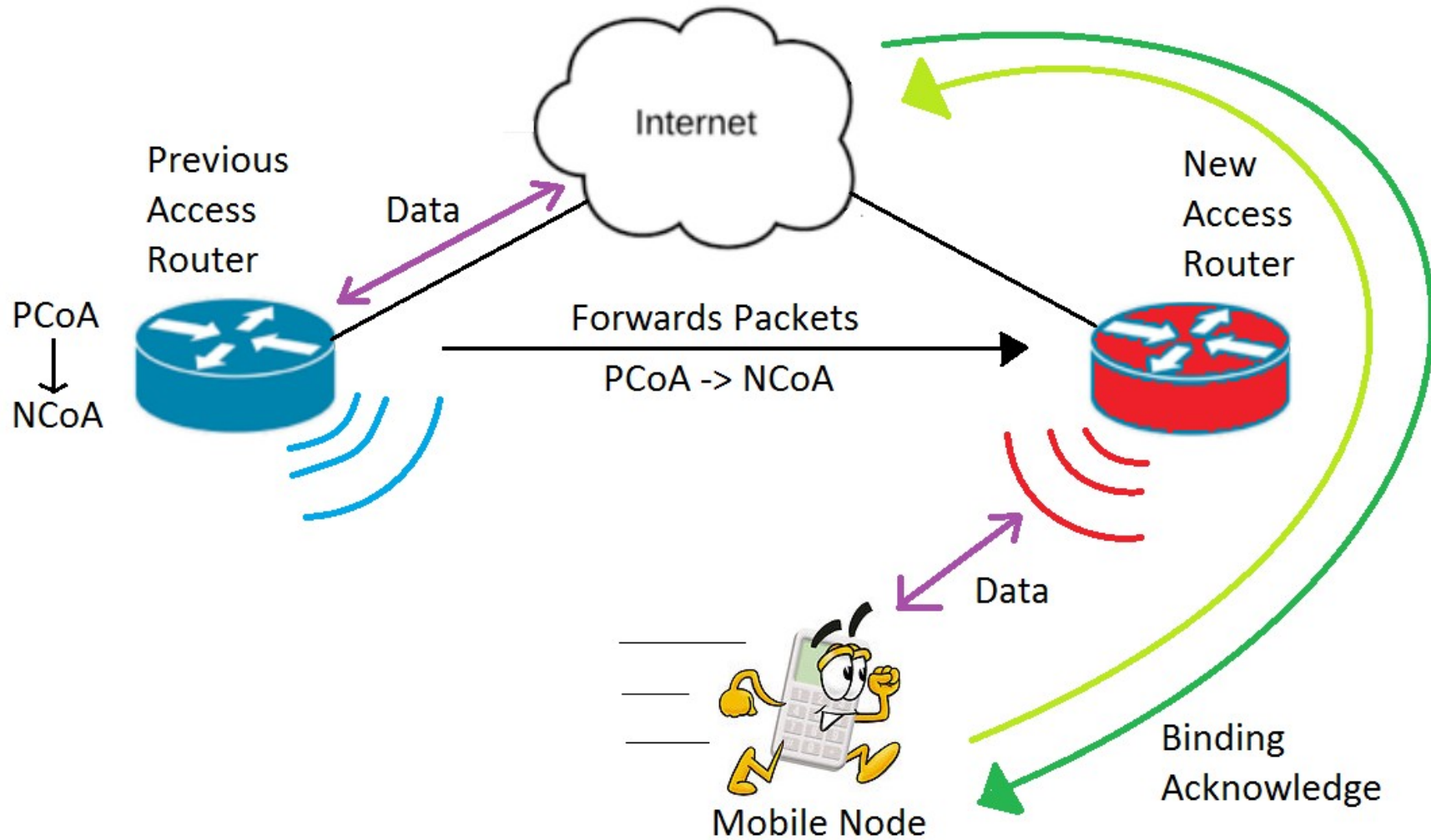

Predictive Fast Handover

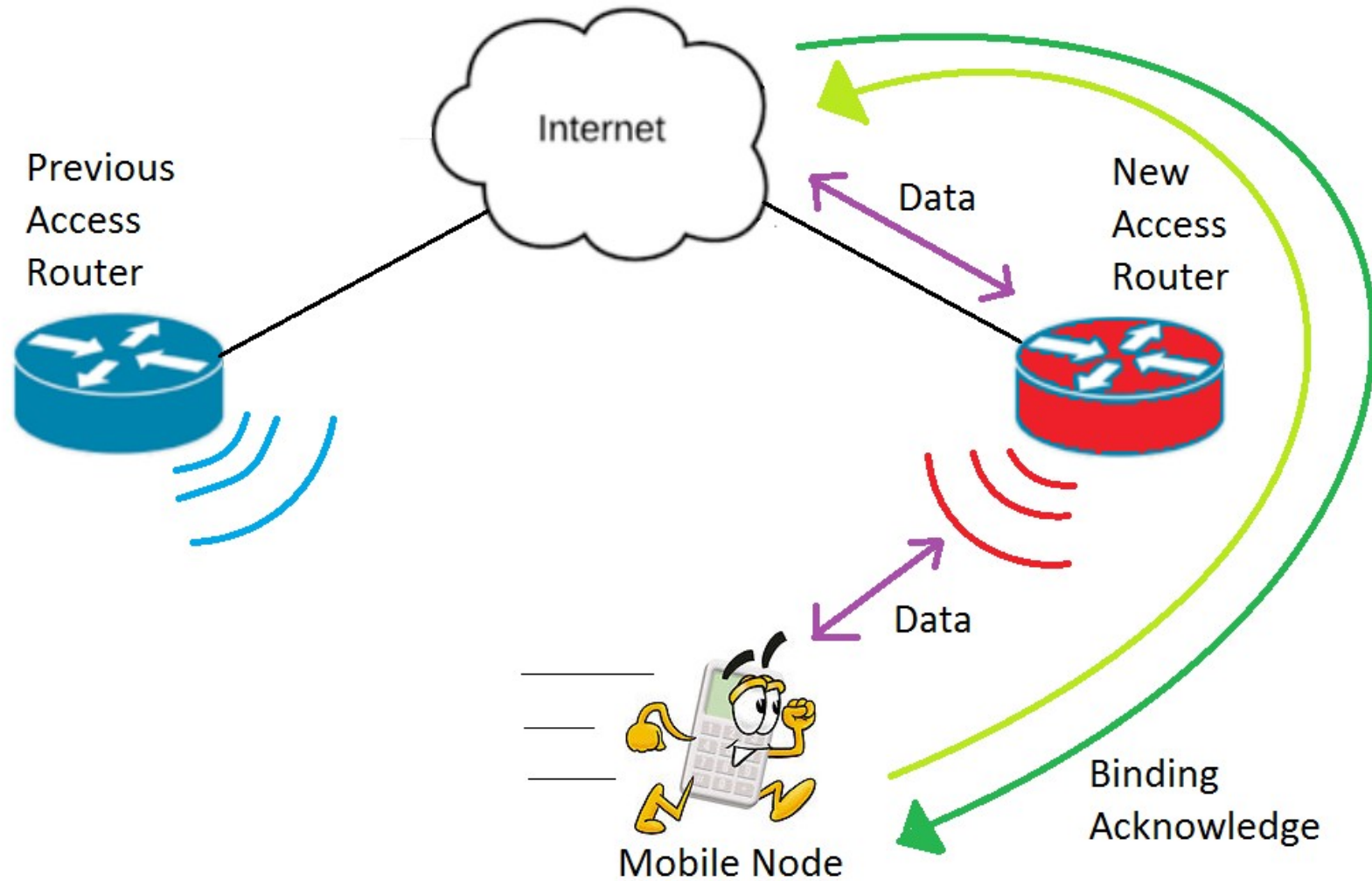

Predictive Fast Handover

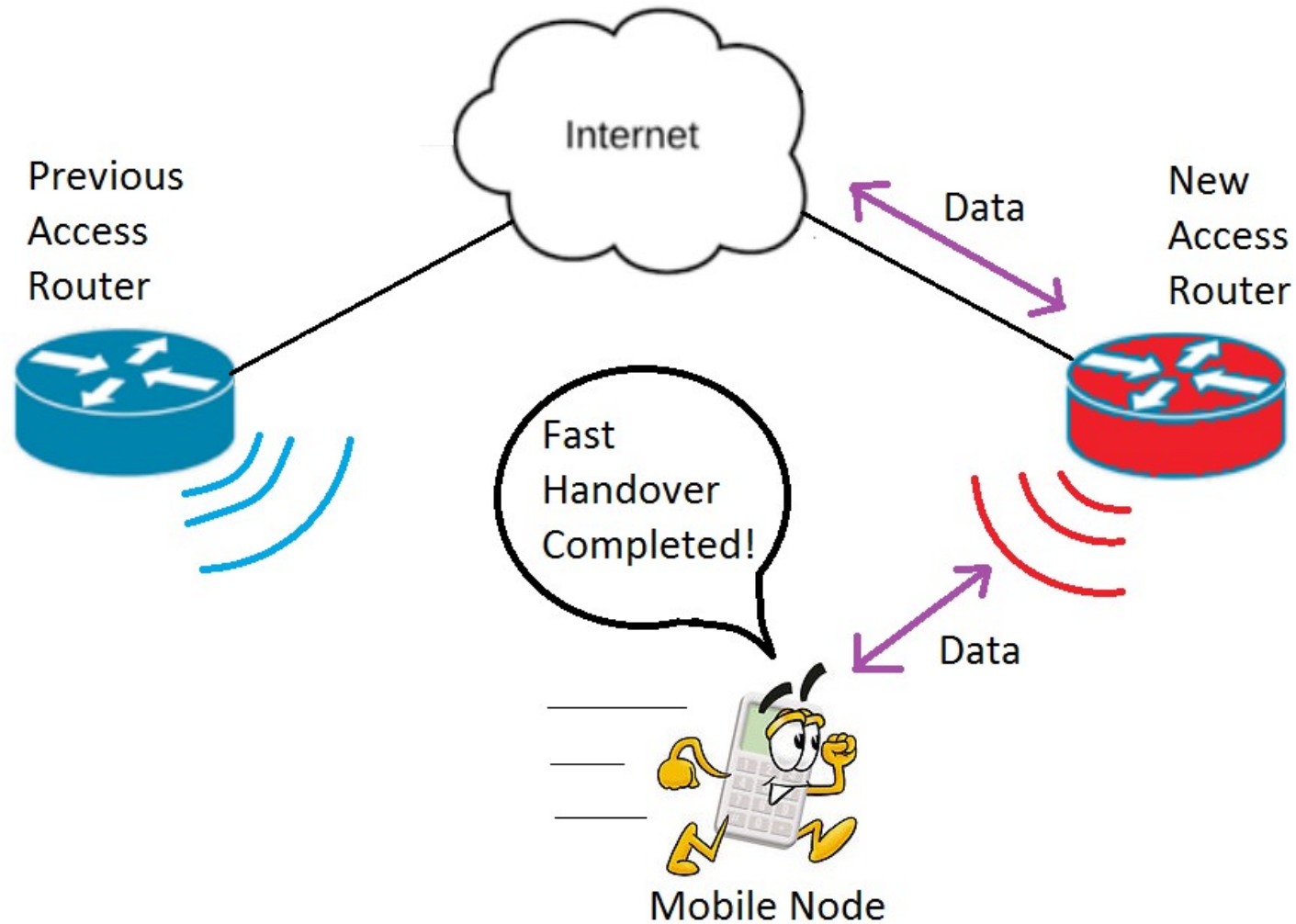

- That was Predictive Fast Handover. Now lets look at Reactive Fast Handover.



Reactive Fast Handover

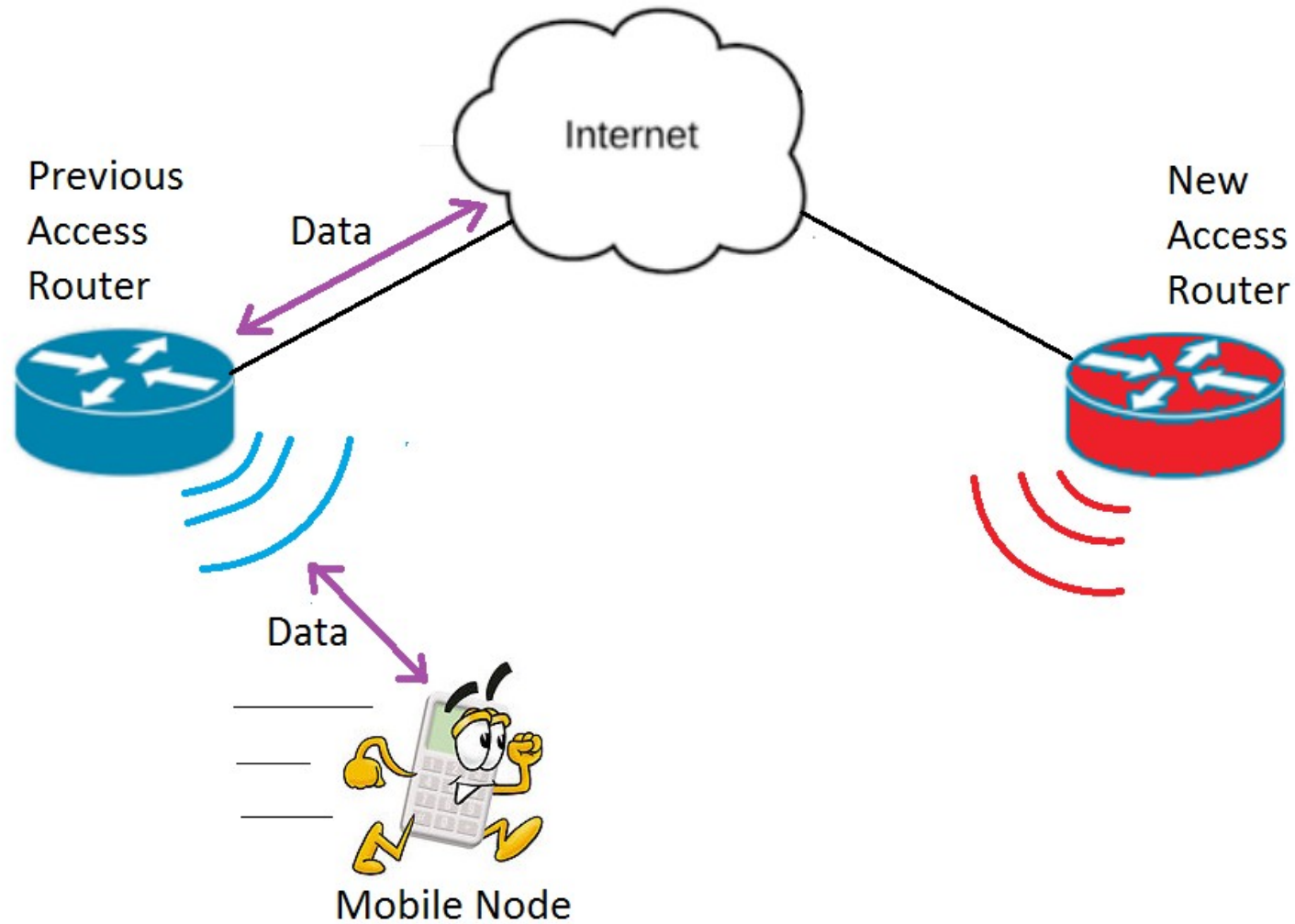

Reactive Fast Handover

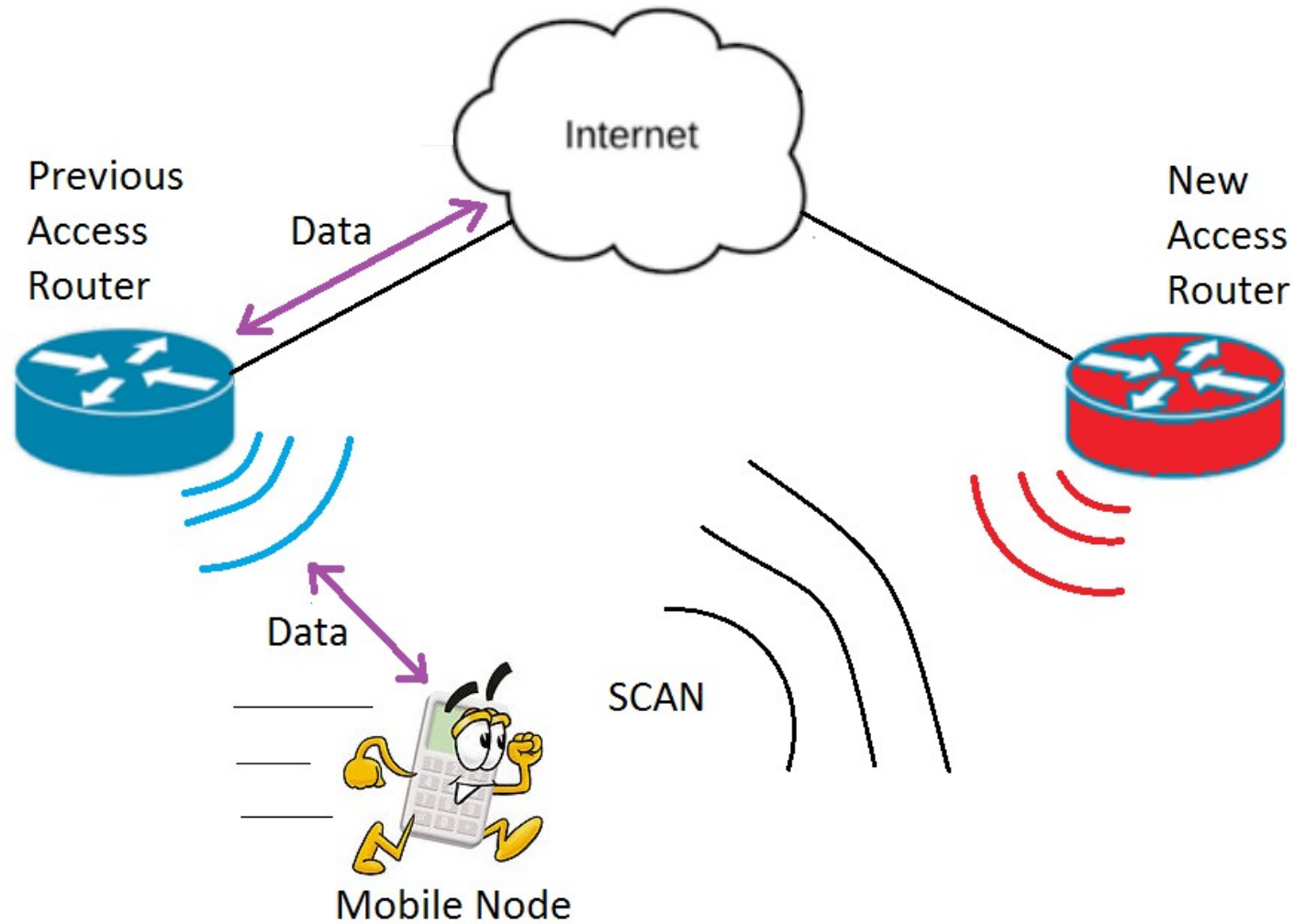

Reactive Fast Handover

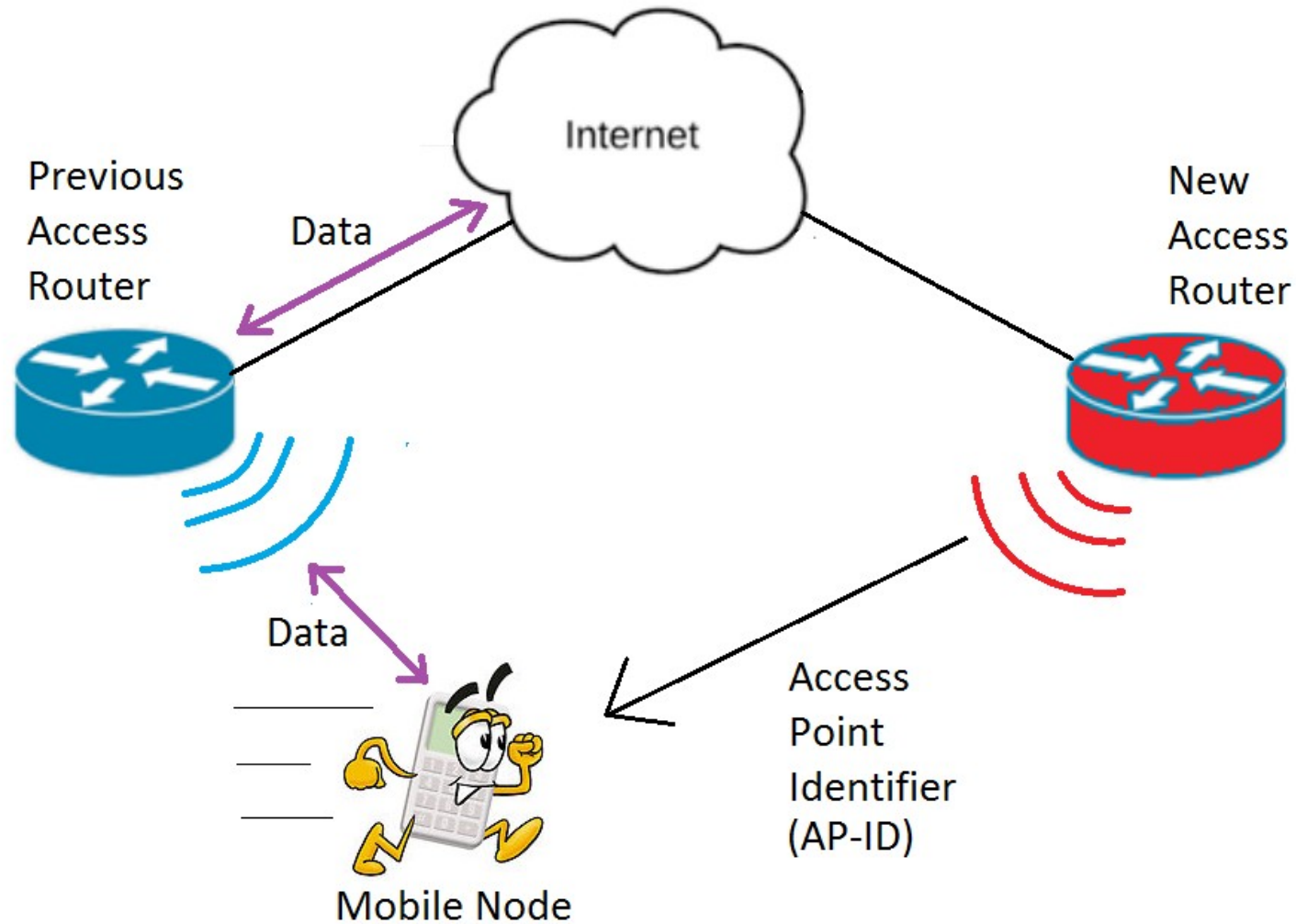

Reactive Fast Handover

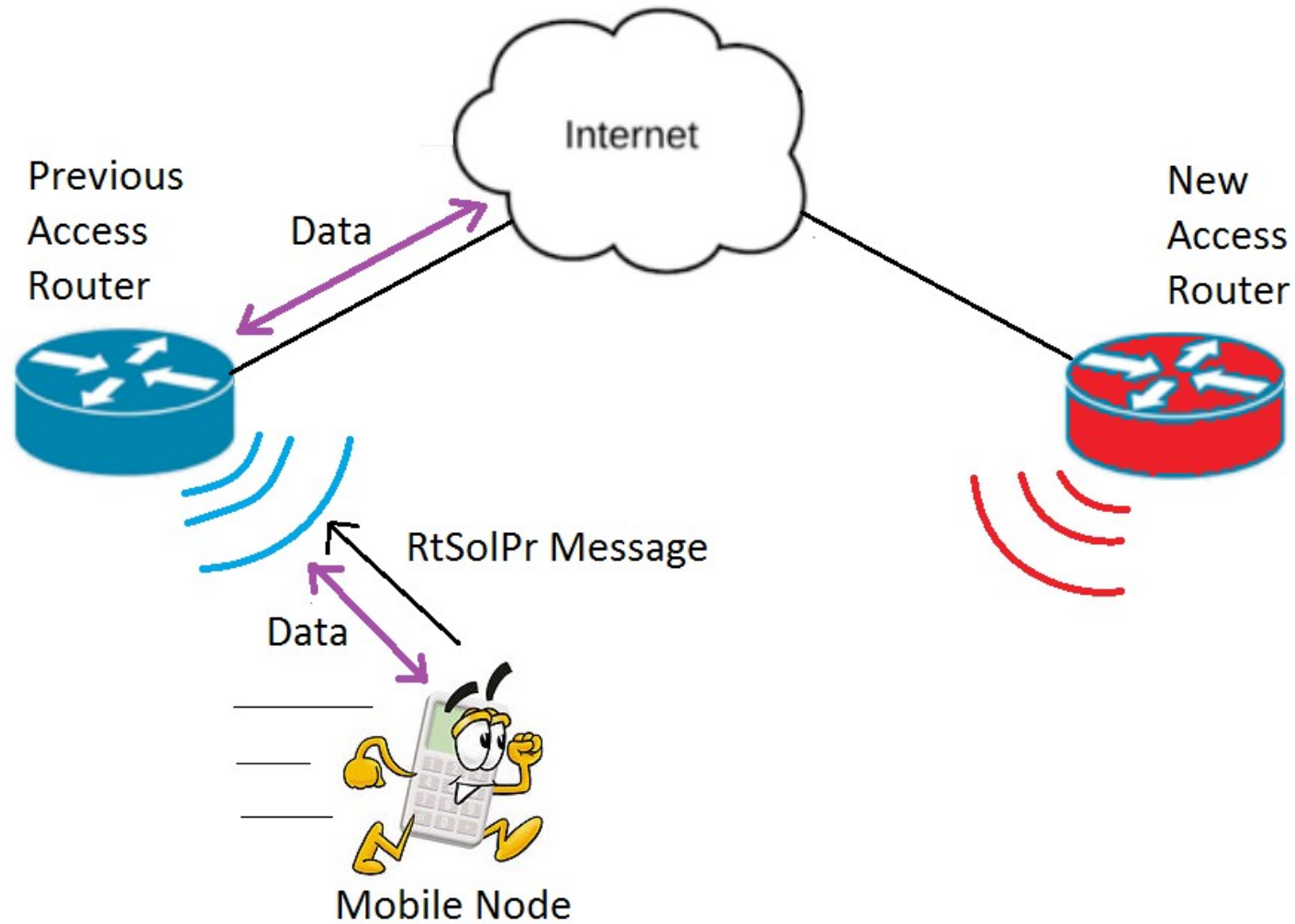

Reactive Fast Handover

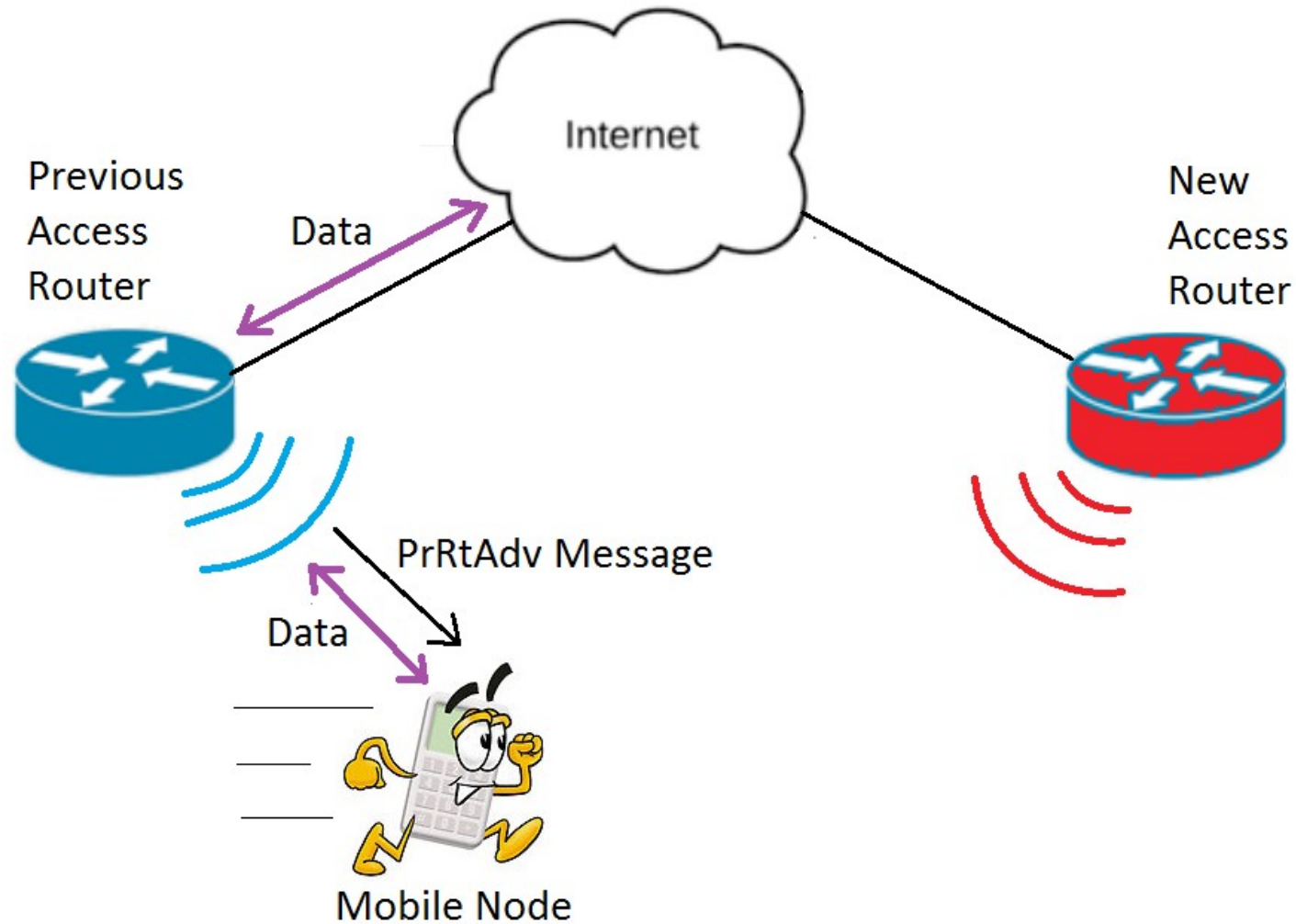

Reactive Fast Handover

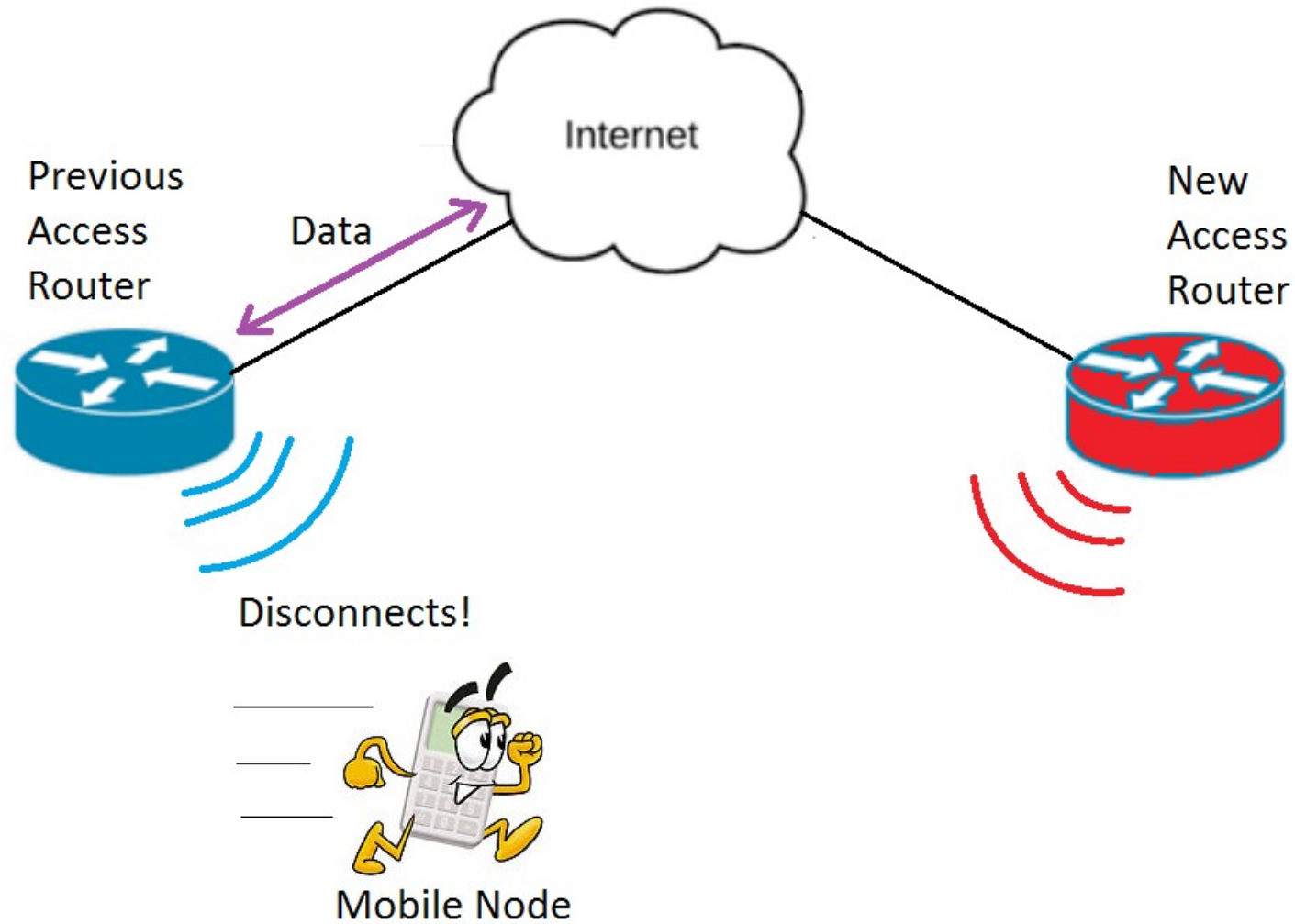

Reactive Fast Handover

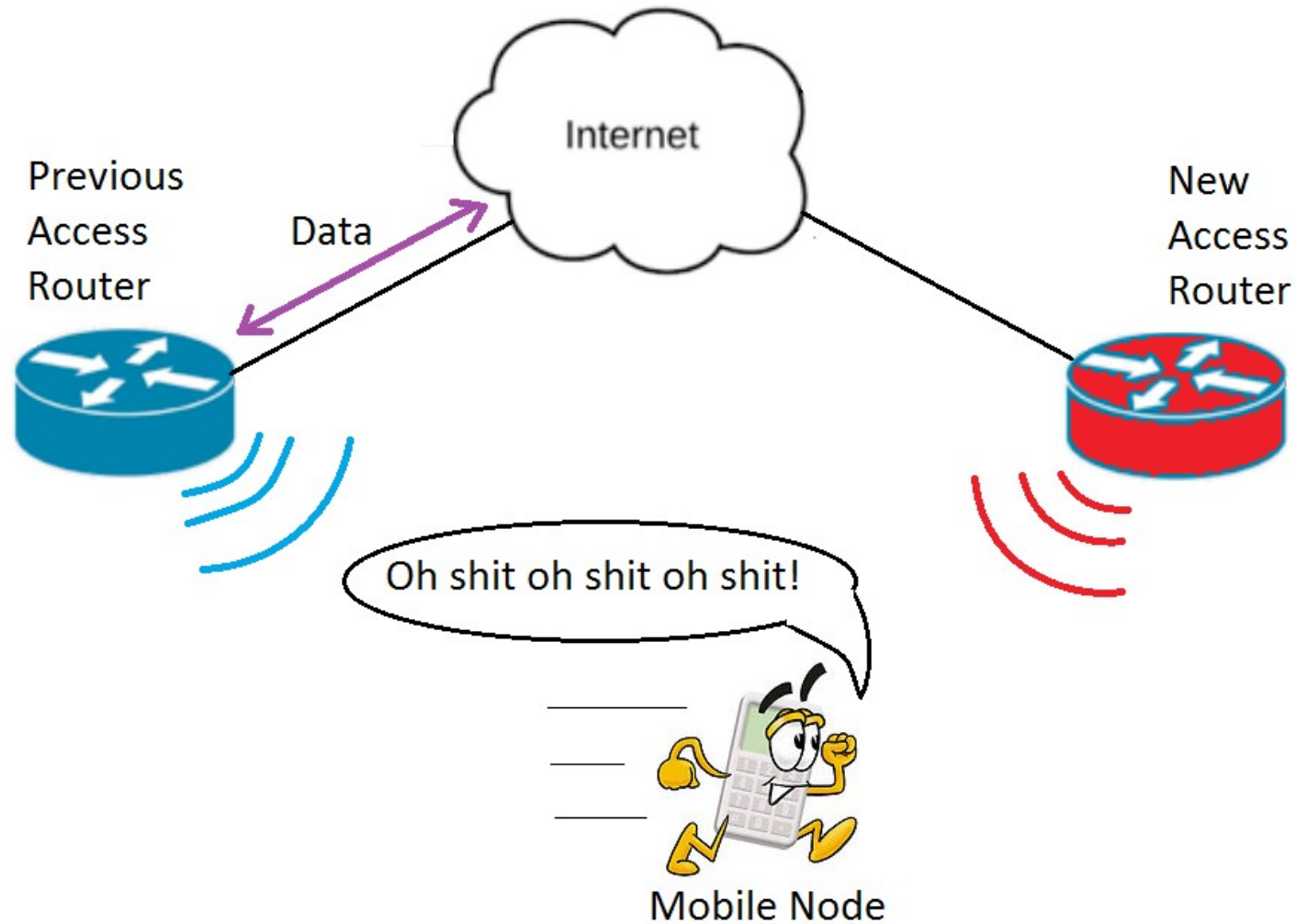

Reactive Fast Handover

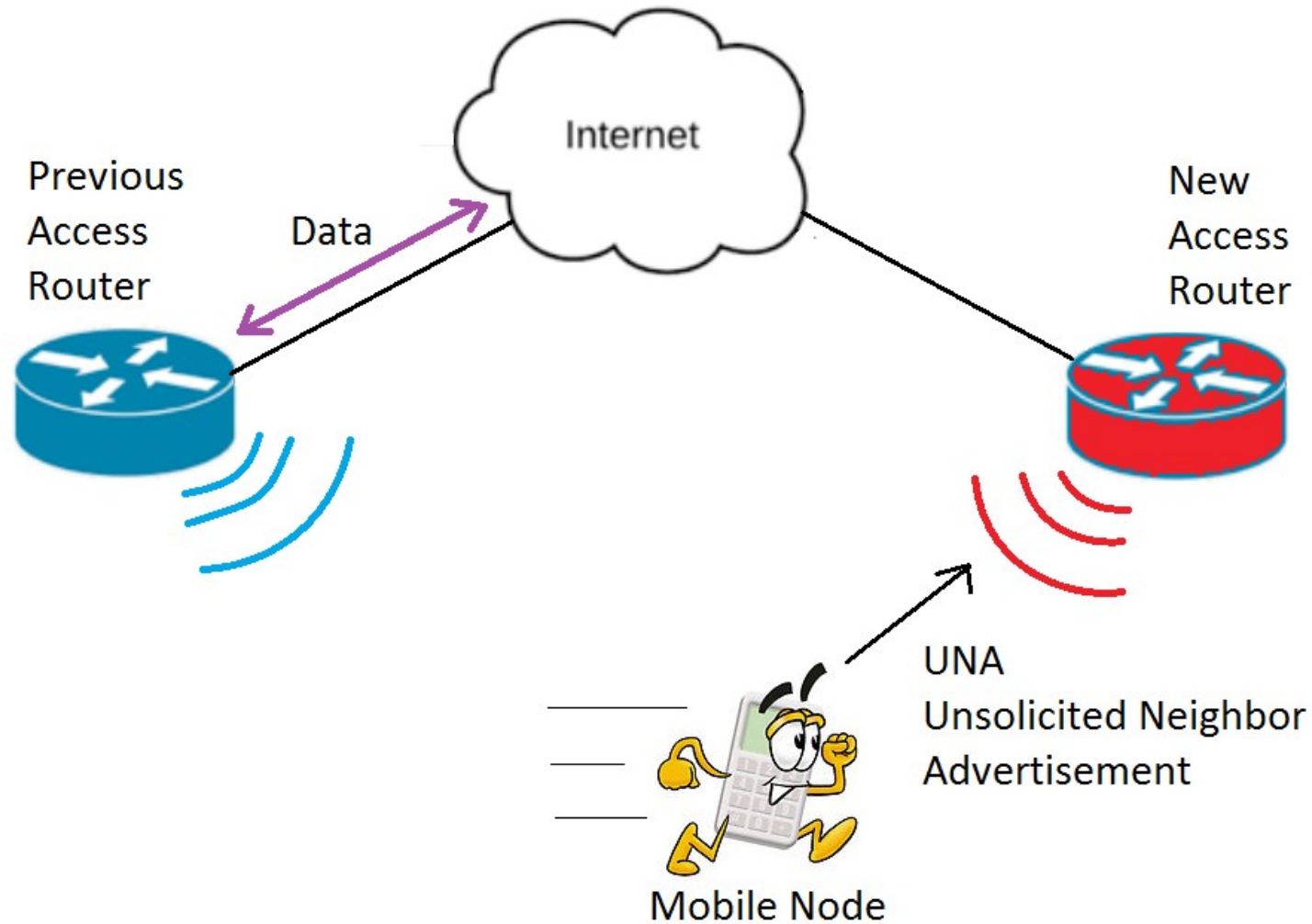

Reactive Fast Handover

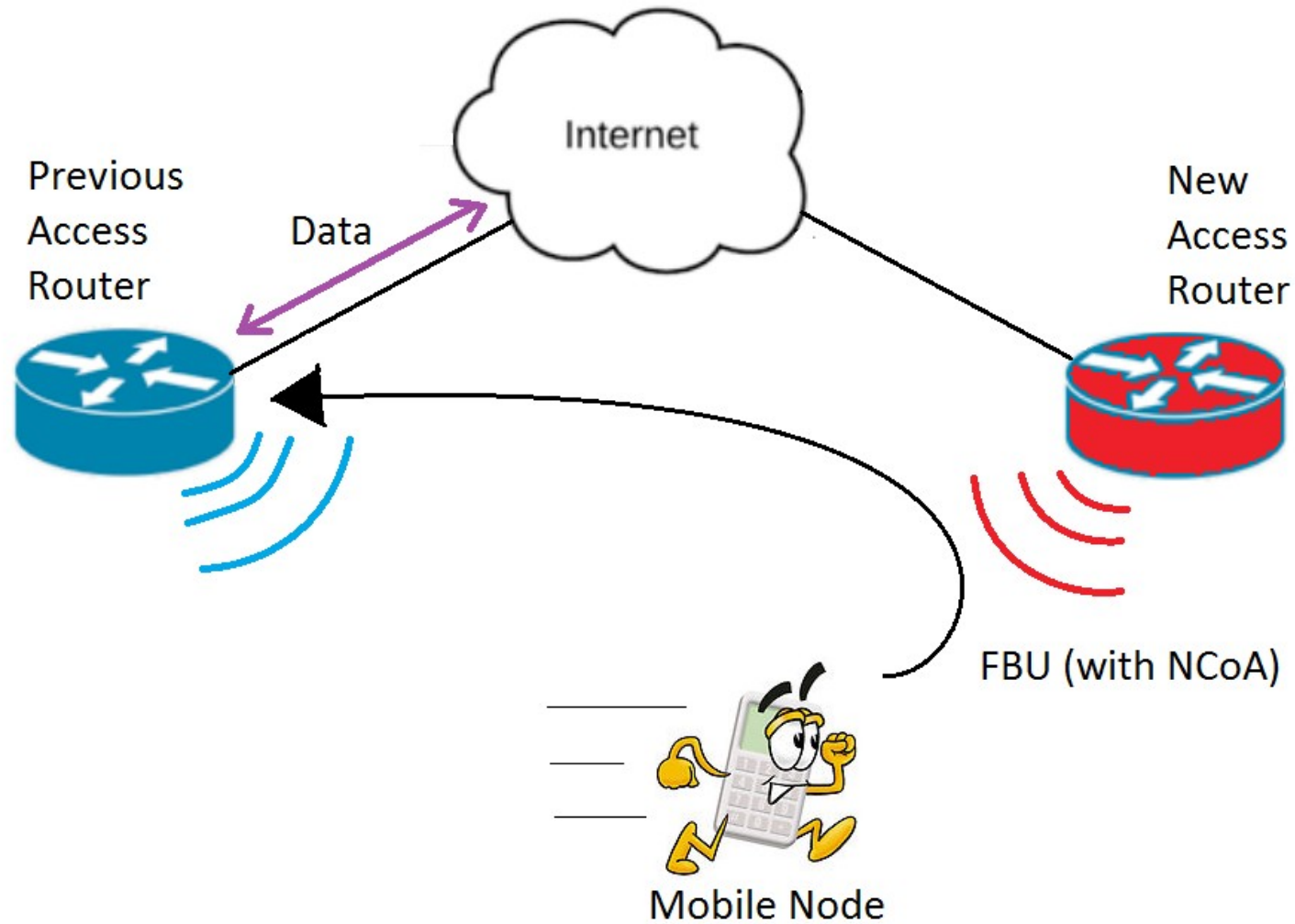

Reactive Fast Handover

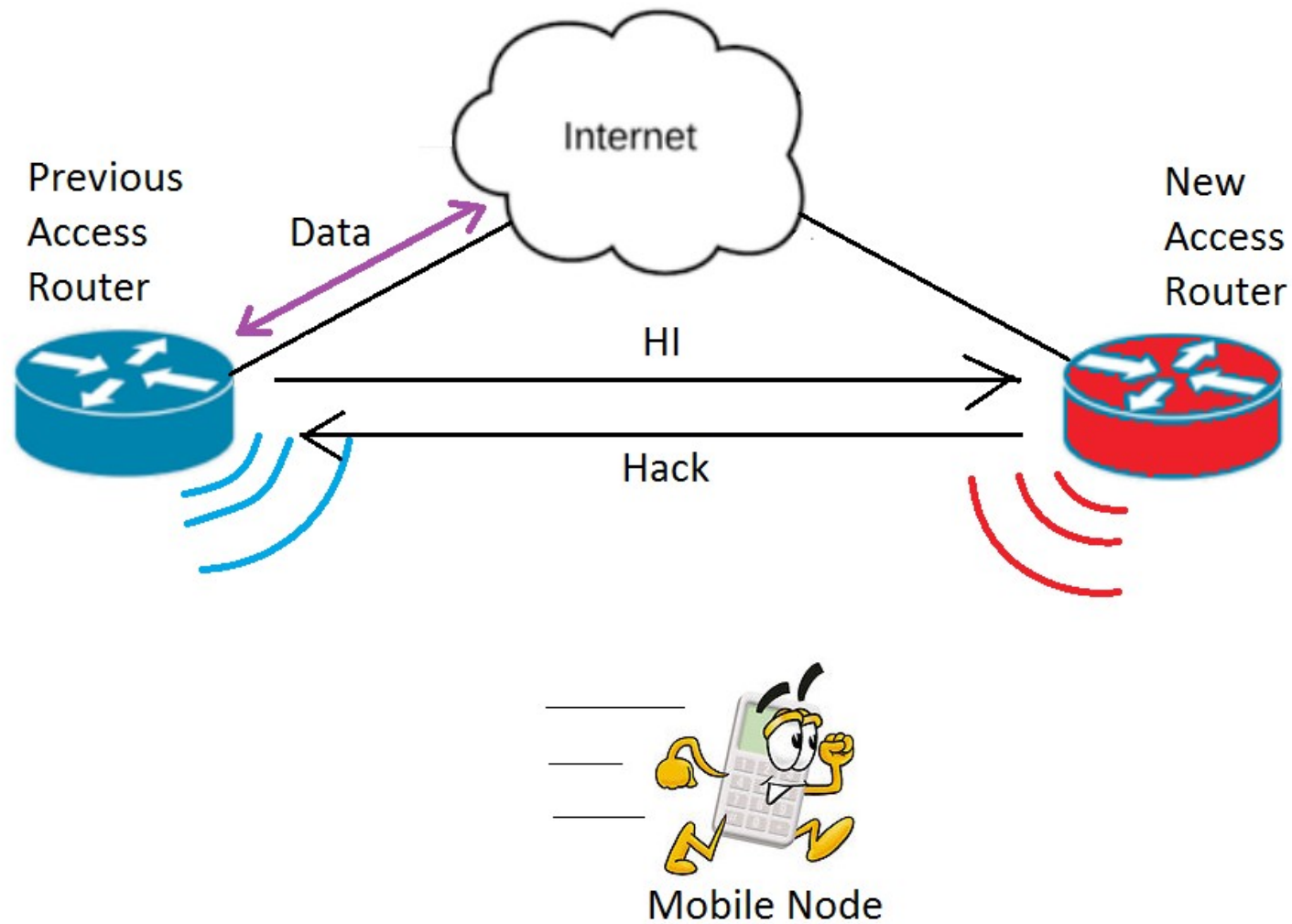

Reactive Fast Handover

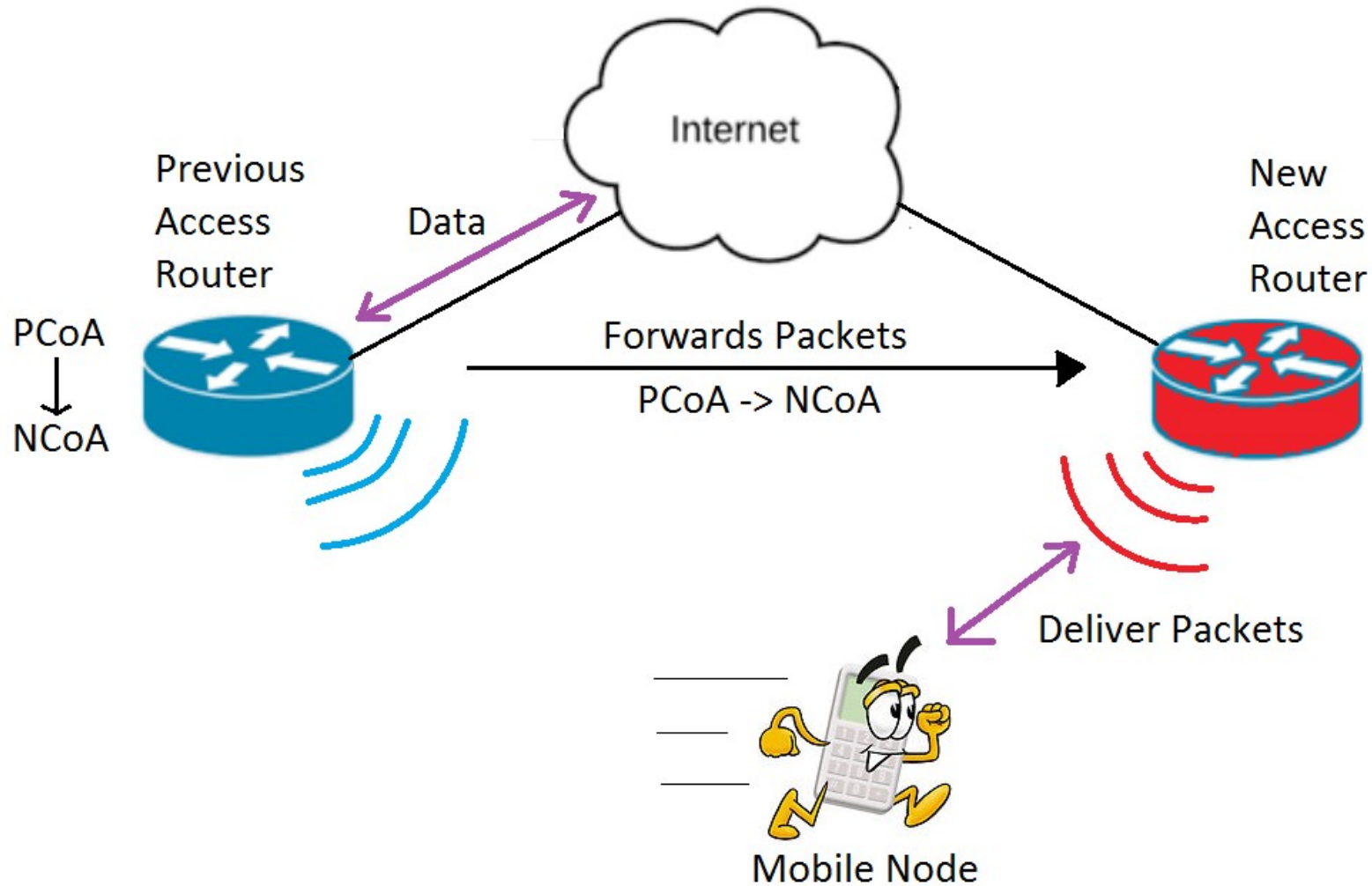

Reactive Fast Handover

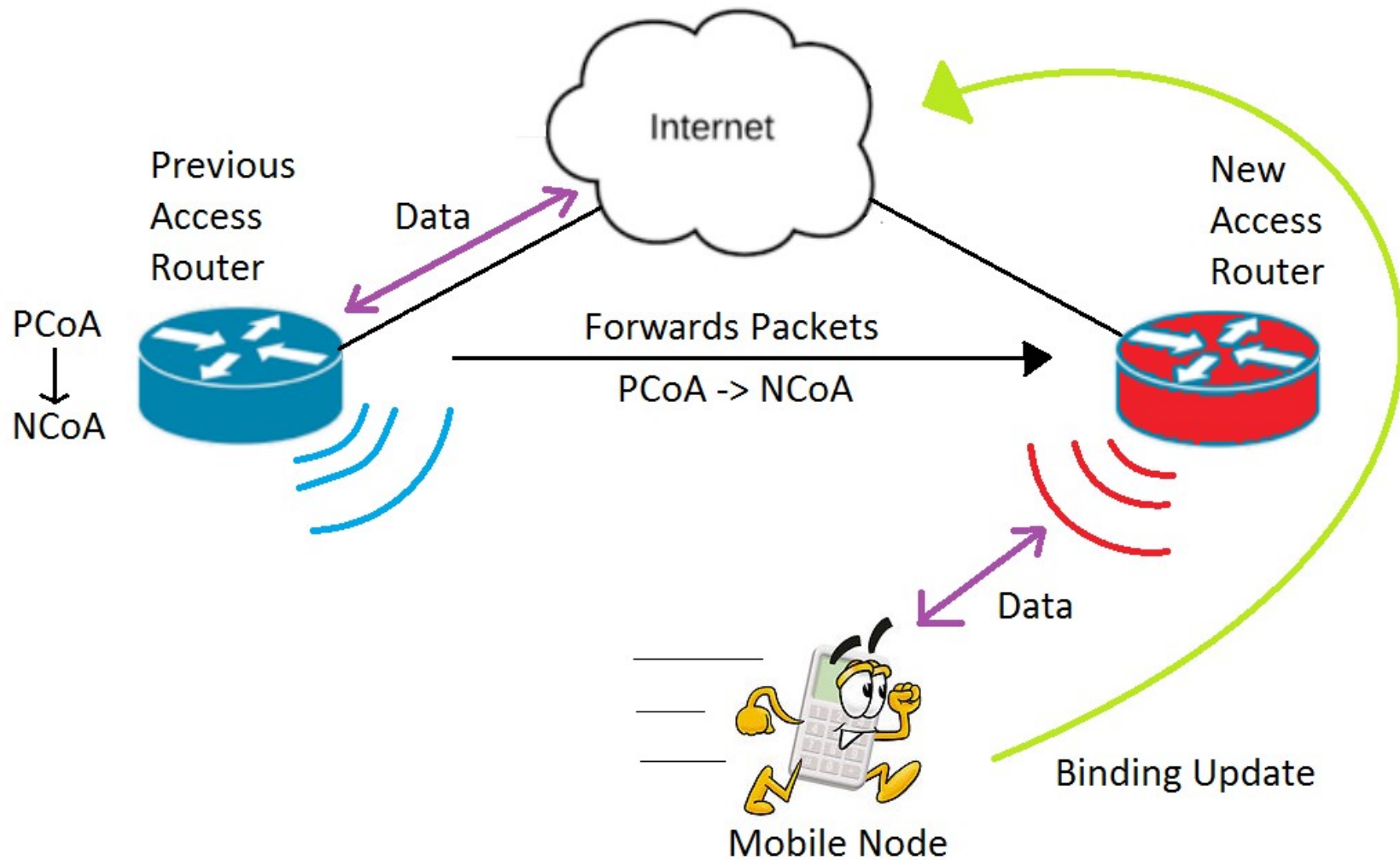

Reactive Fast Handover

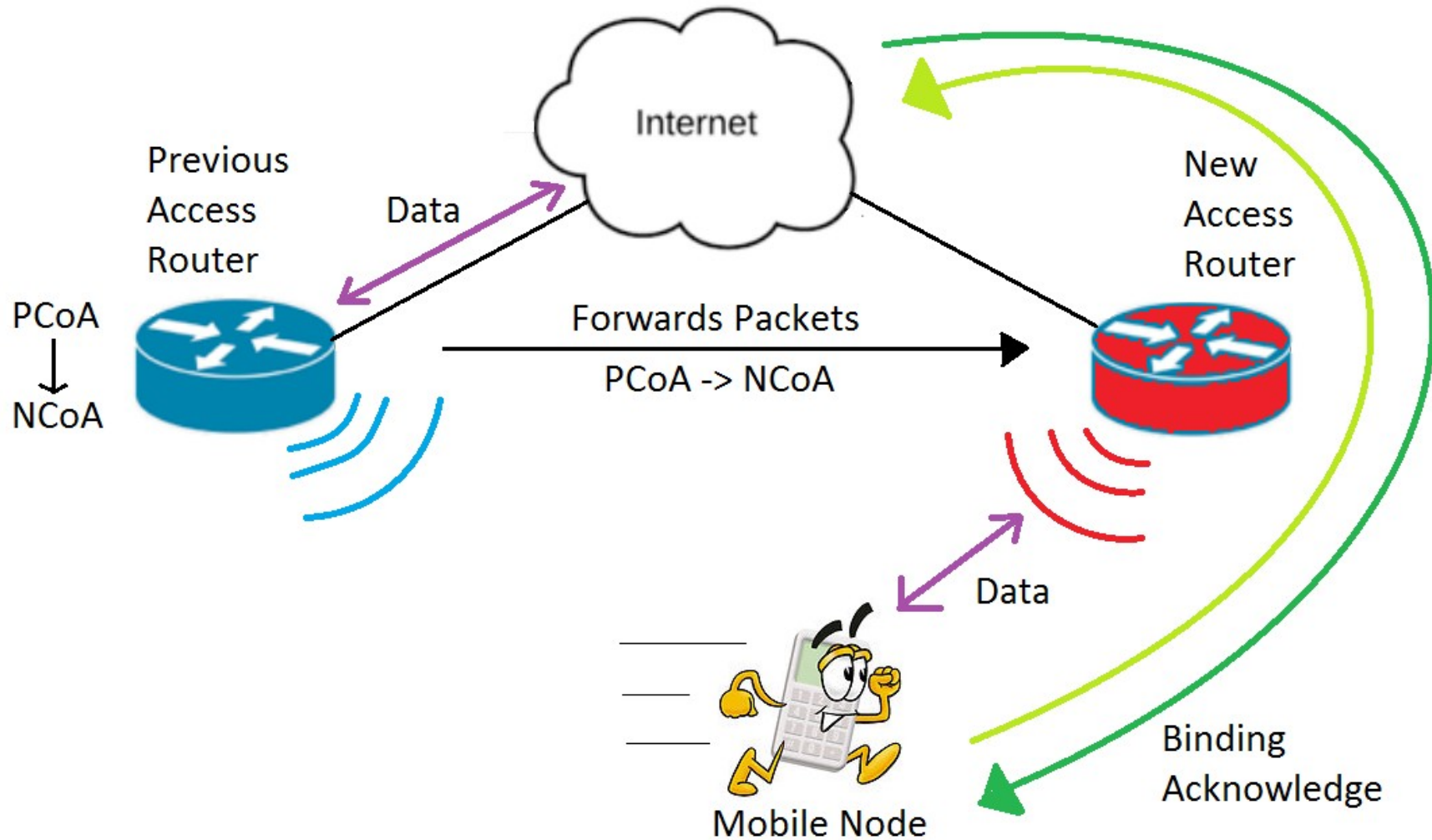

Reactive Fast Handover

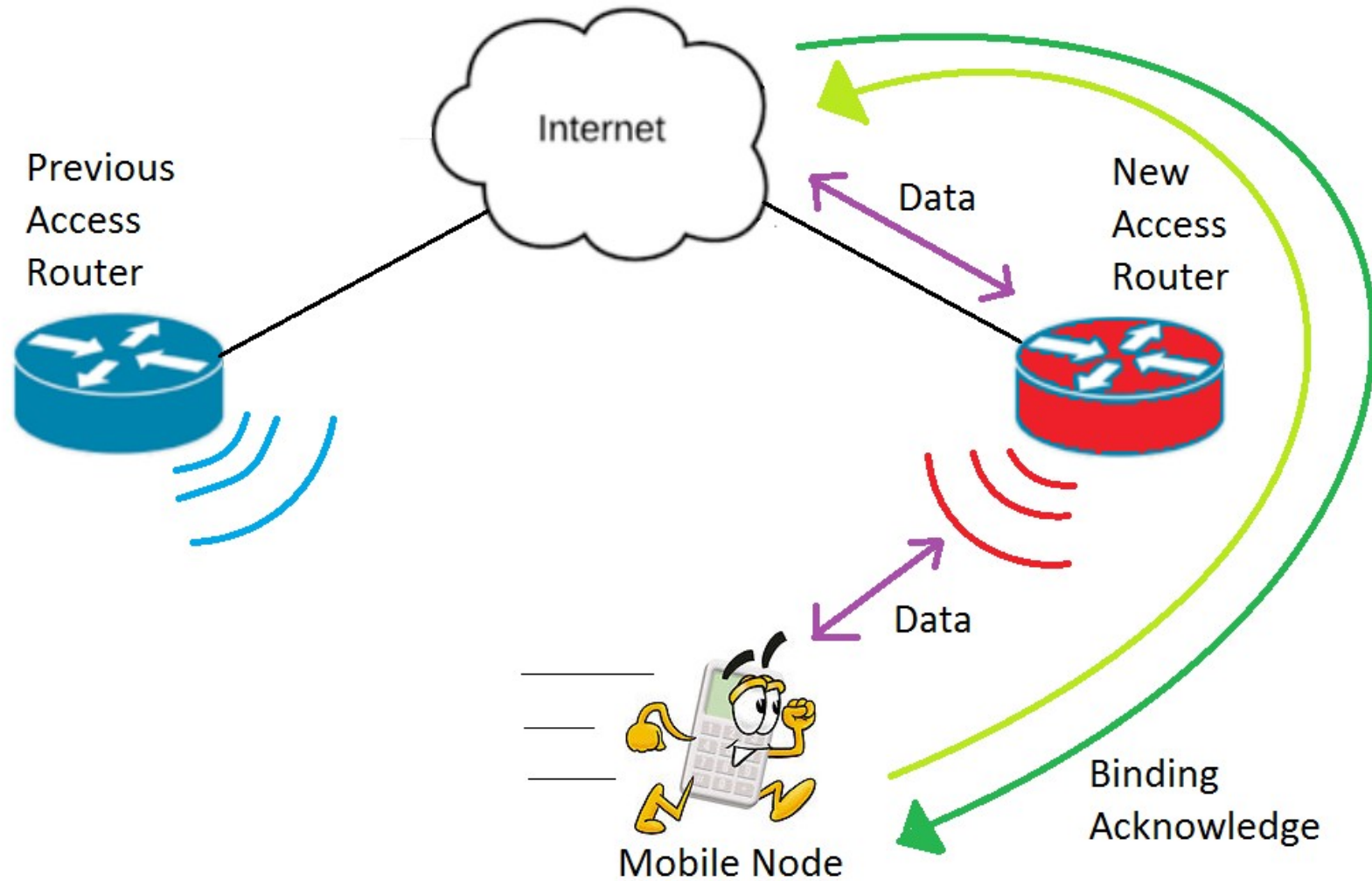

Reactive Fast Handover

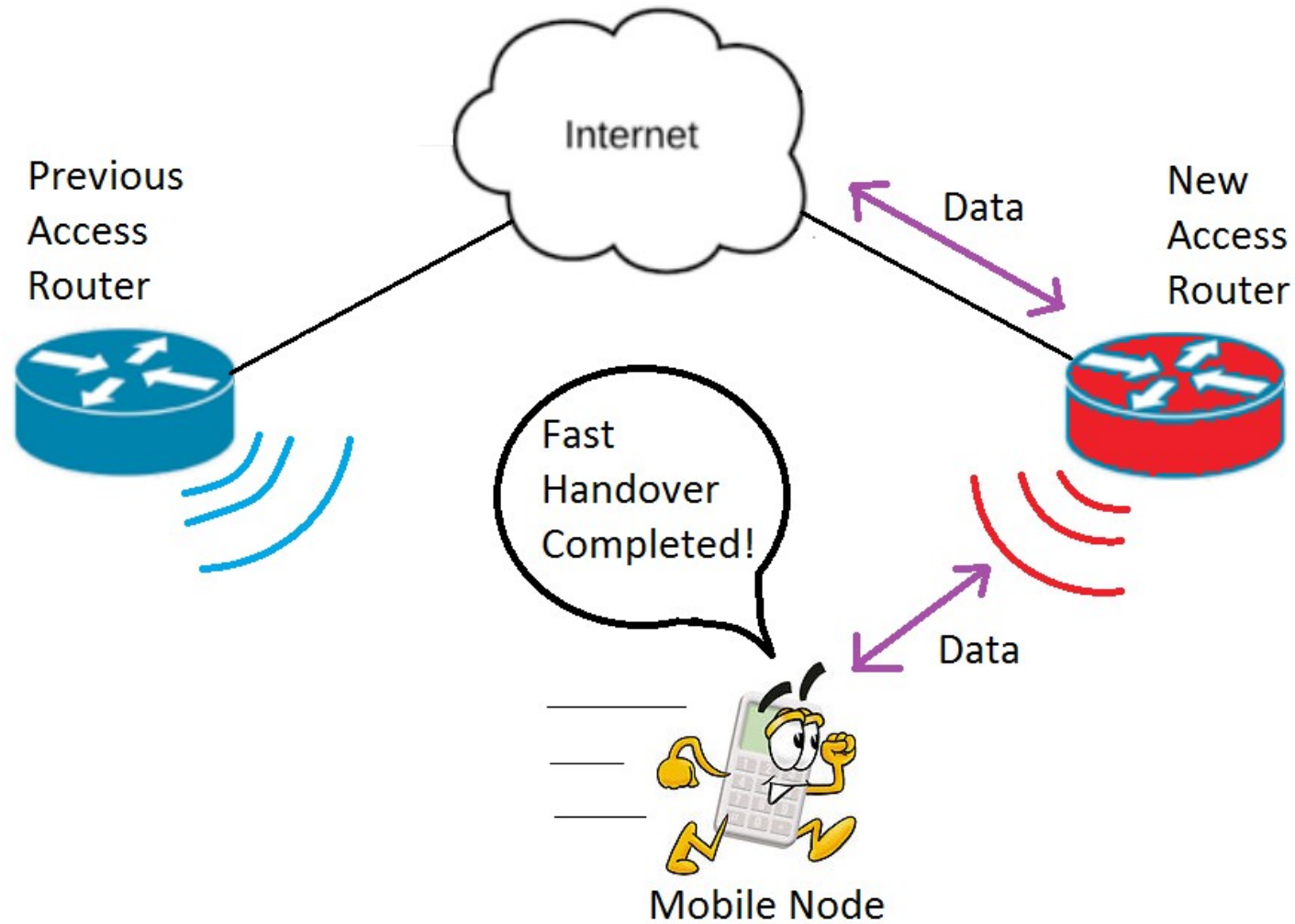

- That was Reactive Fast Handover.
- Fast Handover can also be initiated by the Network itself.
- The Previous Access Router then sends an PrRtAdv when it decides that a handover is imminent or needed.
- Resembles Predictive Fast Handover.

Sometimes Fast Mobile IP doesn't work...

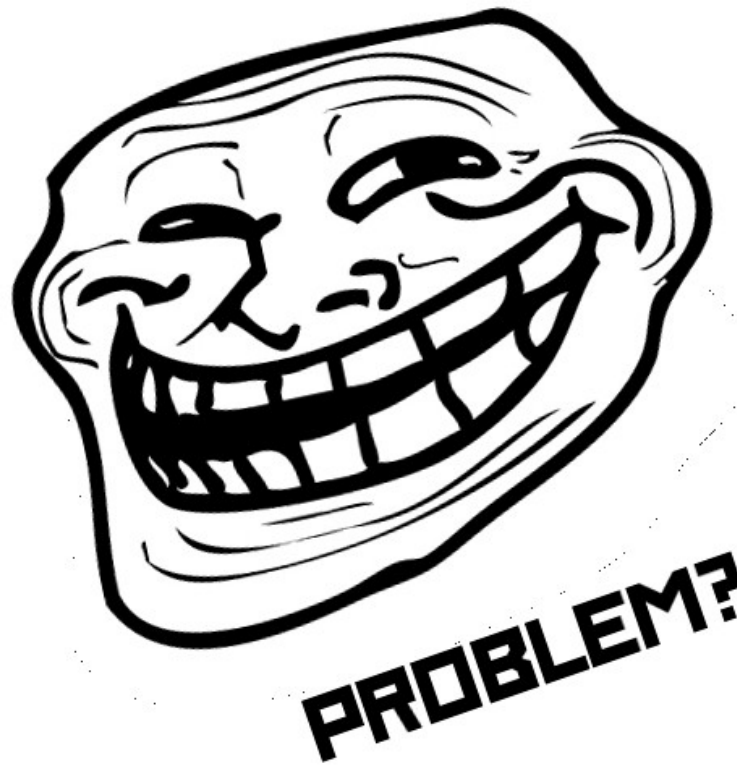

Reasons why Fast Handover isn't used

- The Previous Access Router doesn't have an entry for the New Access Router (may try reactive fast handover)
- Several Access points are bridged into a wired network.
- The New Access Router doesn't support Fast Handover

Other considerations

- Determining new Care-of-Address
- Packet loss, «buffer overflow»
- Fast or Erroneous movement (Ping Pong)

Questions and comments

