

The exponential growth of mobile data traffic affects not only the capacity requirements of the mobile networks but even the expected Quality of Service. Introduction of LTE improved the situation to some extent. However as a high percent of mobile data traffic is generating from indoors, LTE at higher frequencies cannot really meet the ever increasing demand of data traffic and reasonable QoS. This Book provides an analysis of the network throughput with LTE technology that includes macro and indoor traffic distribution pattern using system level simulation environment. Simulation results show that with increasing percentage of indoor traffic, the throughput of macro network decreases significantly. Lately, two possible solutions emerged to offload the indoor traffic by WiFi or Femtocell. A brief overview of the two solutions is presented and the more promising, femtocells are further evaluated. The analysis shows the increase in macro network throughput by offloading the traffic via femtocells. Deployment of Femtocells can surely be of great interest to both users and operators providing users with good QoS and operators with low CapEx and OpEx while providing the high revenue.



Ayaz Khan Afridi



Ayaz Khan Afridi

MS:Network Services and Systems at Royal Institute of Technology (KTH),Sweden, Thesis:at University Graduate Studies (UNIK),Norway, B.E:Computer Systems Engineering at National University of Sciences and Technology (NUST), Pakistan, Worked as Senior Engineer,Access Network,WorldCall Wireless Telecom (WLL Project,CDMA 2000 1X RTT) Pvt. Ltd. Pakistan

Macro and Femto Network Aspects For Realistic LTE Usage Scenarios

Impact of increasing indoor traffic on macro network and macro effective offloading using LTE System Level Simulator

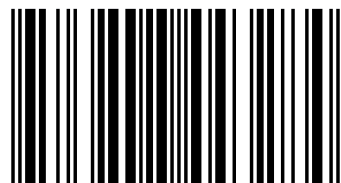

978-3-8484-4328-4



Ayaz Khan Afridi

**Macro and Femto Network Aspects For Realistic LTE Usage
Scenarios**

Ayaz Khan Afridi

Macro and Femto Network Aspects For Realistic LTE Usage Scenarios

**Impact of increasing indoor traffic on macro
network and macro effective offloading using LTE
System Level Simulator**

LAP LAMBERT Academic Publishing

Impressum/Imprint (nur für Deutschland/only for Germany)

Bibliografische Information der Deutschen Nationalbibliothek: Die Deutsche Nationalbibliothek verzeichnet diese Publikation in der Deutschen Nationalbibliografie; detaillierte bibliografische Daten sind im Internet über <http://dnb.d-nb.de> abrufbar.

Alle in diesem Buch genannten Marken und Produktnamen unterliegen warenzeichen-, marken- oder patentrechtlichem Schutz bzw. sind Warenzeichen oder eingetragene Warenzeichen der jeweiligen Inhaber. Die Wiedergabe von Marken, Produktnamen, Gebrauchsnamen, Handelsnamen, Warenbezeichnungen u.s.w. in diesem Werk berechtigt auch ohne besondere Kennzeichnung nicht zu der Annahme, dass solche Namen im Sinne der Warenzeichen- und Markenschutzgesetzgebung als frei zu betrachten wären und daher von jedermann benutzt werden dürften.

Coverbild: www.ingimage.com

Verlag: LAP LAMBERT Academic Publishing GmbH & Co. KG
Heinrich-Böcking-Str. 6-8, 66121 Saarbrücken, Deutschland
Telefon +49 681 3720-310, Telefax +49 681 3720-3109
Email: info@lap-publishing.com

Approved by: Stockholm, Royal Institute of Technology (KTH), Feb, 2011

Herstellung in Deutschland (siehe letzte Seite)

ISBN: 978-3-8484-4328-4

Imprint (only for USA, GB)

Bibliographic information published by the Deutsche Nationalbibliothek: The Deutsche Nationalbibliothek lists this publication in the Deutsche Nationalbibliografie; detailed bibliographic data are available in the Internet at <http://dnb.d-nb.de>.

Any brand names and product names mentioned in this book are subject to trademark, brand or patent protection and are trademarks or registered trademarks of their respective holders. The use of brand names, product names, common names, trade names, product descriptions etc. even without a particular marking in this works is in no way to be construed to mean that such names may be regarded as unrestricted in respect of trademark and brand protection legislation and could thus be used by anyone.

Cover image: www.ingimage.com

Publisher: LAP LAMBERT Academic Publishing GmbH & Co. KG
Heinrich-Böcking-Str. 6-8, 66121 Saarbrücken, Germany
Phone +49 681 3720-310, Fax +49 681 3720-3109
Email: info@lap-publishing.com

Printed in the U.S.A.

Printed in the U.K. by (see last page)

ISBN: 978-3-8484-4328-4

Copyright © 2012 by the author and LAP LAMBERT Academic Publishing GmbH & Co. KG and licensors

All rights reserved. Saarbrücken 2012

To my family

especially,

my late grandma, may her soul rest in peace. Ameen

ACKNOWLEDGMENTS

This work was completed at UNIK, Norway during the period of April 2010 - Feb 2011. I am deeply grateful to my external supervisors Prof. Dr. Josef Noll and Mushfiqur Rahman Chowdhury, who have been my instructors for my research work. I am grateful for their help and Co-operation, encouragement and invaluable guidance throughout the work. I must extend my gratitude to my internal supervisor, Professor Viktoria Fodor for being always so supportive and cooperative.

I am deeply and always obliged to my family for their love, support and encouragement throughout my entire life.

At the end, my sincere thanks goes to the members of Norwegian Femto-Forum for the valuable discussion and input.

TABLE OF CONTENTS

CHAPTER		PAGE
1	INTRODUCTION	1
1.1	Background	1
1.2	Future Challenges and Goals	1
1.3	Thesis Layout	2
2	CELLULAR TECHNOLOGIES	3
2.1	History of Cellular Networks	3
2.2	Beyond 3G Networks	4
2.3	Long Term Evolution (LTE) Technology	6
2.4	WCDMA Compatibility Issues With LTE	9
2.4.1	OFDMA Access Technique	9
2.4.2	Transmission Capacity	10
2.4.2.1	WCDMA Capacity	10
2.4.2.2	OFDMA Capacity	12
2.5	Evolution of 4G LTE Network	16
3	THE FEMTOCELL SOLUTION SERVING INDOOR USERS	17
3.1	Indoor Traffic in Cellular Mobile Networks	17
3.1.1	Mobile Data Traffic	17
3.1.1.1	New Applications and Usage Pattern	17
3.1.1.2	Emergence of New Devices	18
3.1.2	Impact of Indoor Data Traffic	18
3.1.2.1	Capacity Degradation in Indoor	19
3.1.3	WiFi Technology	21
3.2	Solutions for Efficient Service of Indoor Users	22
3.2.1	Femtocells	22
3.2.1.1	Network Management with Femtocells	22
3.2.1.2	Business Impact on Operators	23
4	METHODOLOGY AND SIMULATOR DEVELOPMENT	24
4.1	Simulation Tools	24
4.1.1	OMNeT++	24
4.1.1.1	Scope of OMNeT++	26
4.1.2	MATLAB based LTE Simulators	27
4.1.2.1	LTE Link Level Simulator	27
4.1.2.2	LTE System Level Simulator	27
4.1.2.2.1	Simulator Structure	28
4.1.2.2.2	Simulator Development	29
5	PERFORMANCE EVALUATION	30
5.1	Simulation Scenarios for Performance Evaluation	30
5.2	Scenario without the Deployment of Femtocells	34

TABLE OF CONTENTS (Continued)

<u>CHAPTER</u>		<u>PAGE</u>
	5.2.1 Simulation Results	37
	5.3 Dense Deployment of Femtocells	40
	5.3.1 Simulation Results	41
6	FUTURE WORK AND CONCLUSION	48
	6.1 Conclusion	48
	6.2 Future Work	48
	REFERENCES	49
	APPENDICES	53

LIST OF TABLES

<u>TABLE</u>		<u>PAGE</u>
I	LTE RADIO ATTRIBUTES	8
II	CAPACITY GAINS, OFDMA VERSUS WCDMA	15
III	ASSUMED PARAMETERS IN LTE CAPACITY CALCULATION FOR INDOOR AND OUTDOOR TRAFFIC	20
IV	BASIC PARAMETERS FOR LTE SIMULATION ENVIRONMENT . .	32
V	BASIC PARAMETERS FOR FEMTOCELLS ENVIRONMENT	41

LIST OF FIGURES

<u>FIGURE</u>	<u>PAGE</u>
1	3GPP Standards 6
2	Capacity Performance Comparison: WCDMA versus OFDMA, SINR=10 dB 13
3	Capacity performance comparison: WCDMA versus OFDMA, SINR=0 dB 14
4	Relative Capacity in Indoor to Outdoor Scenario for LTE Network 21
5	Sample format in OMNeT++ NED file 26
6	Schematic block diagram of LTE System Level Simulator [10]. 28
7	Shadow fading with mean of 0 dB and standard deviation of 10 dB 33
8	20% indoor users with shadow fading map 35
9	90% indoor users with shadow fading map 36
10	Network layout with pathloss, 7 eNodeBs with different SINR values 37
11	Decreasing throughput by increasing percentage of indoor UEs 39
12	Increasing femtocells aggregated throughput by increasing percentage of indoor UEs 42
13	Comparison of macro network throughput; with and without femtocells . . . 44
14	Effective offloading by femtocells for different percentage of indoor UEs . . 46
15	Effective offloading by femtocells (50% to 100% indoor UEs) 47
16	(a) Growth of mobile data traffic volume, (b) Contribution to mobile data traffic in 2014 (based on application type), (c) Contribution to mobile data traffic in 2014 (based on device type) [24]. 54

LIST OF ABBREVIATIONS

AMCS	Advance Modulation and Coding Scheme
BLER	Block Error Rate
CQI	Channel Quality Indicator
CP	Cyclic Prefix
CapEx	Capital Expenditure
EESM	Exponential Effective Signal to Interference and Noise Ratio Mapping
E-UTRA	Evolved Universal Terrestrial Radio Access
eNodeB	Evolved NodeB
FAP	Femto Access Point
FDD	Frequency Division Duplex
HRPD	High Rate Packet Data
HSPA	High Speed Packet Access
ITU	International Telecommunication Union
LTE	Long Term Evolution
MRC	Maximum Ratio Combining
MIESM	Mutual Information Effective Signal to Interference and Noise Ratio Mapping
MIMO	Multiple Input Multiple Output
OFDMA	Orthogonal Frequency Division Multiple Access
OMNeT	Objective Modular Network Testbed

LIST OF ABBREVIATIONS (Continued)

OpEx	Operational Expenditure
PRBs	Physical Resource Blocks
SCFDMA	Single Carrier Frequency Division Multiple Access
SISO	Single Input Single Output
SINR	Signal to Interference and Noise Ratio
TDD	Time Division Duplex
TTIs	Transmission Time Intervals
UE	User Equipment
WCDMA	Wideband Code Division Multiple Access

CHAPTER 1

INTRODUCTION

1.1 Background

According to the International Telecommunication Union (ITU), the number of mobile subscribers have reached 5 billion at the end of year 2010 [1], [24]. This type of growth mostly takes place in voice dominated market. The mature market is not growing from number of subscribers point of view rather this section of market is growing from data traffic point of view. Due to this, the global access of mobile broadband connection reached 9.5% in 2009, more than the fixed broadband access [2], [24]. The dominating part of the mobile broadband traffic is coming from laptops with in-built or USB modem and it is originating mostly from indoor [3], [24]. The higher percentage of indoor traffic is due to the increasing usage of video applications on mobile devices. Introduction of the LTE technology enhanced the capacity of the network and provided a solution to the capacity hungry network to some extent. But the ever-increasing trend of indoor traffic contribution to overall mobile data traffic still degrades the user's quality of service all over the network. It requires to offload such enormous contribution of indoor traffic from the macro network to indoor network. Recently two possible solutions have emerged, one is to deploy femtocell and another is the use of WiFi.

1.2 Future Challenges and Goals

It is seen that the mobile data traffic will double every year till 2014 and the estimation in the form of Compound Annual Growth Rate (CAGR) is 108% in the period of 2010-2014 [4], [24]. Emergence of new devices and applications, and their usage pattern are responsible for such growth. Moreover, the high indoor penetration loss at higher LTE frequencies decreases the overall capacity of the cell hence results poor quality of service for indoor users. This is a big challenge for operators to improve

the capacity and quality of service of the network. The increasing growth requires increased network capacity which generates good revenue for operator's business model. The goal of the thesis is to provide performance evaluation of LTE network throughput. In this research a system level simulation environment is developed that included macro; a cellular network comprises of 7 Evolved NodeBs (eNodeBs) or Base Stations, and indoor traffic distribution pattern. Results show that with increasing percentage of indoor traffic the aggregated throughput of the macro network decreases significantly. Later, the same work is performed in the presence of femtocells for serving the indoor users and showing that aggregated throughput of macro network increased significantly when femtocells are deployed for indoor users. The thesis work also shows effective offloading by femtocells which is a point of interest from operator's business perspective.

1.3 Thesis Layout

This work is organized as follows: chapter 2 gives some overview of the history and flow of cellular technologies, transmission capacity comparison of WCDMA versus OFDMA and introduction to LTE is also part of the same chapter; chapter 3 presents the main drivers behind the enormous growth of mobile data traffic and the available technologies to offload the indoor traffic along with business management of femtocells from operator's point of view; chapter 4 highlights the available simulation tools and the suitable choice amongst them for the simulation setup; simulation environment setup for the computation of LTE macro network throughput and the performance evaluation of simulation results is discussed in detail in chapter 5; conclusion with the highlights of future work is given in chapter 6.

CHAPTER 2

CELLULAR TECHNOLOGIES

2.1 History of Cellular Networks

The tremendous growth in wireless cellular industry reached to 4 billion over the past decades [9]. In 1981, the first international mobile communication system, namely the Nordic Mobile Telephony (NMT) system was introduced in the Nordic countries. At the same time, the analog Advanced Mobile Phone System (AMPS) was introduced in North America. The First Generation (1G) analogue network only supported voice with limited roaming. With the introduction of digital communication during 1980s, the interest in developing a successor to the analog communication system appeared and provided the foundation towards the evolution of the 2G mobile communication system. The second generation digital network supported better quality voice, enhanced capacity and widespread roaming then did by the analogue system counterpart. Enhancement in roaming part was due to few standards and common spectrum allocation particularly in Europe. Global System for Mobile communication (GSM) and IS95 standards, 2G technologies are two widely deployed cellular systems. GSM is based on Frequency and Time Division Multiple Access (FDMA/TDMA) while IS95 is based on Code Division Multiple Access (CDMA) technique. The 2G cellular networks are mainly designed for voice communication; in later release they are made capable for data transmission but still data rates were lower than dialup. Both GSM and CDMA systems formed their own standards, 3G partnership projects (3GPP) and 3GPP2 respectively so that to develop newer technologies based on CDMA technology. The International Telecommunication Union-Radio (ITU-R) project on International Mobile Telecommunication IMT-2000 smoothed the way for 3G networks, the main features were high data rates i.e. 2 Mbps and vehicular mobility. In 1980s, ITU-R initiated the Universal

Mobile Telecommunication System (UMTS) which is referred to as the 3G mobile communication system. 3G system is based on Wideband CDMA (WCDMA). The 3G standard technology in 3GPP is referred to WCDMA which uses 5 MHz bandwidth while CDMA2000 in 3GPP2 uses 1.25 MHz bandwidth. Later on 3GPP2 also developed its own standard and the frequency band was extended to 5 MHz composed of three 1.25 MHz which is then called CDMA2000-3x. To differentiate both standards, 5 MHz CDMA is called CDMA-3x and single carrier of 1.25 MHz CDMA is called CDMA-1x or 3G-1x [9]. The first release of these standards didn't fulfill their promises and the expecting data transmission was too lowered than the practical one. After serious efforts, 3GPP2 introduced High Rate Packet Data (HRPD) service which uses advance techniques for data optimization such as channel sensitive scheduling, fast link adaptation and hybrid ARQ etc. However, HRPD required a separate 1.25 MHz subcarrier for data transmission only with no voice on the same carrier and hence initially it was called CDMA2000-1x EVDO (evolution data only). 3GPP followed the same way and enhanced WCDMA; developed HSPA (High Speed Packet Access) and used the same access techniques, the only difference was that the voice and data use the same bandwidth of 5 MHz, they are multiplexed in downlink. 3GPP2 also developed CDMA2000-1x EVDO to CDMA2000-1x EVDV which means (evolution data and voice). Both data and voice use the same subcarrier of 1.25 MHz but never used commercially. Later on, in HRPD Voice over IP (VoIP) was introduced to support both voice and data on the same carrier. Both of these new technologies fulfilled the need for high data transmission in 3G and deployed in major markets of world [9].

2.2 Beyond 3G Networks

While HRPD and HSPA were in the process of deployment, in the meanwhile IEEE 802 LMSC (LAN/MAN Standard Committee) introduced a new standard that is IEEE 802.16e for mobile broadband wireless access which is the enhanced version of IEEE 802.16 for fixed wireless broadband.

This standard uses new access technology OFDMA (Orthogonal Frequency Division Multiple Access) and provides better data rates than HSPA and HRPD technologies. The IEEE 802.16 family of standards is officially called WirelessMAN in IEEE. It is also titled as Worldwide Interoperability for Microwave Access (WiMAX) by an industry group named the WiMAX forum. The duty of WiMAX forum is to check the compatibility and interoperability. The WiMAX supported mobility just as in IEEE 802.16e standard is called mobile WiMAX. With the introduction of new standard specifically Mobile WiMAX led both 3GPP and 3GPP2 to their own newer version beyond 3G by utilizing new access technology OFDMA and similar network architecture like Mobile WiMAX. The beyond 3G in 3GPP standard is called Evolved Universal Terrestrial Radio Access (EUTRA) technology. This technology in 3GPP is widely known as Long Term Evolution (LTE). While in 3GPP2 standard, similar is developed which is known as Ultra Mobile Broadband (UMB) [9]. Fig. 1 shows the evolution of 3GPP standards.

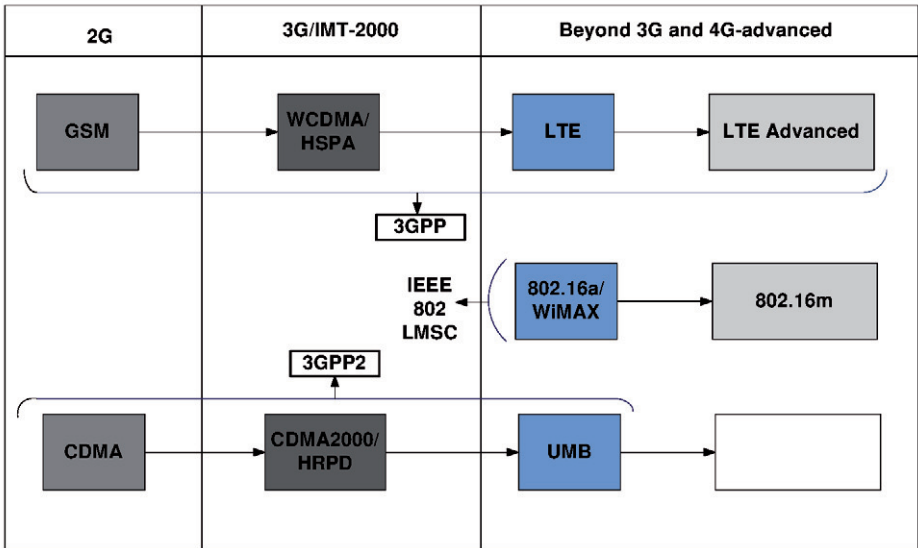

Figure 1. 3GPP Standards

2.3 Long Term Evolution (LTE) Technology

HSPA is treated as 3.5G, beyond 3G or Super 3G. LTE is regarded as a pre-4G as it does not fulfill the International Telecommunication Union (ITU-R) requirements for data rate and heterogeneity of networks. However, businesses roll-out with LTE are often called 4G. LTE can operate in the frequency range from 900 MHz to 2.6 GHz. LTE is aimed to provide high data rate, low latency and packet optimized radio access technology supporting flexible bandwidth deployment. LTE supports a wide range of bandwidth from 1.25 MHz to 20 MHz. The 20 MHz bandwidth gives peak data rate of 326 Mbps using 4x4 Multiple Input Multiple Output (MIMO). For uplink, MIMO is not yet

implemented so the uplink data rate is limited to 86 Mbps [9]. It supports Orthogonal Frequency Division Multiple Access (OFDMA) which gives high robustness and spectral efficiency against multipath fading. While comparing to HSPA, LTE provides high spectral efficiency of two to four times. Moreover, LTE system in terms of its radio interface network is capable of providing low latency for packet transmission of 10 ms from network to User Equipment (UE). Similarly, there is some improvement in cell edge performance, utilizing the same macro network. LTE supports both unicast and multicast traffic in microcells up to 100 of meters and in macro cells more than 10 km in radius. LTE system also supports FDD (Frequency Division Duplex) and TDD (Time Division Duplex), in its Half-FDD, UE is not require to transmit and receive at the same time which avoids the requirement of costly duplexer in UE. Generally, it is optimized for 15 km/h but can be used up to 350 km/h with some tolerance to performance degradation. For its uplink it uses Single Carrier FDMA (SC-FDMA) access technique which gives greater coverage for uplink with the fact of low Peak to Average Power Ratio (PAPR). For this purpose new network architecture is designed with the aim to support packet switched traffic with seamless mobility, low latency and high quality of service (QoS). Some basic LTE parameters related to air interface is summarized in Table I.

TABLE I

LTE RADIO ATTRIBUTES

LTE System Features	
Bandwidth	1.25–20MHz
Duplexing	FDD, TDD, half-duplex FDD
Mobility	350 km/h
Multiple access	Downlink OFDMA
	Uplink SC-FDMA
MIMO	Downlink 2×2 , 4×2 , 4×4
	Uplink 1×2 , 1×4
Peak data rate in 20MHz	Downlink 173 and 326 Mb/s for 2×2 and 4×4 MIMO, respectively
	Uplink 86 Mb/s with 1×2 antenna configuration
Modulation	QPSK, 16-QAM and 64-QAM
Channel coding	Turbo code
Other techniques	Channel sensitive scheduling, link adaptation, power control, ICIC and adaptation, power control, ICIC and hybrid ARQ

2.4 WCDMA Compatibility Issues With LTE

Currently 3G system is using Wideband Code Division Multiple Access (WCDMA) access technique with a bandwidth of 5 MHz both in uplink and downlink. In WCDMA different users have assigned different Walsh codes [9] which are multiplexed using same carrier frequency. In downlink, transmission is orthogonal, due to fixed eNodeB with no multipaths, hence the Walsh codes received are synchronized at UEs. While in case of multipath, Walsh codes received are not orthogonal anymore and hence results in Inter Symbol Interference (ISI). The ISI can be eliminated with advance receiver such as Linear Minimum Mean Square Error (LMMSE) receiver. In order to achieve high data rates, the interference problem increases in WCDMA when used with LTE due to multipath for larger bandwidths such as 10 MHz or 20 MHz. This is because of high chip rates in higher bandwidths, which is small in case of lower bandwidths. Similarly complexity of LMMSE also increases due to increased multipaths in large bandwidths. It is also possible to add multiple carriers of 5 MHz to support large bandwidth. However, it increases the complexity of eNodeB and UE. Another issue with WCDMA could be that a bandwidth less than 5 MHz will not be supported by LTE, as LTE supports smaller bandwidths as well. WCDMA only supports multiple of 5 MHz. After careful consideration of LTE flexibility, scalability and compatibility issues associated with WCDMA, it was necessary to employ a new access technique for LTE system.

2.4.1 OFDMA Access Technique

OFDMA approach was first proposed by R.W Chang [9], [20] a few decades ago and analyzed later by Slatzberg [9], [21]. In OFDMA the whole bandwidth is divided into small subcarriers or parallel channels which is then used for transmission with reduced signaling rate. These subcarriers

are orthogonal which means that they do not correlate with each other. The subcarrier frequency is shown in the equation given below,

$$f_k = k\Delta f \quad (2.1)$$

where Δf is the subcarrier spacing. Subcarrier is first modulated with a data symbol of either 1 or 0, the resulting OFDMA symbol is then formed by simply adding the modulated carrier signal. This OFDM symbol has larger magnitude than individual subcarrier and thus having high peak value which is the characteristics of OFDMA technique.

2.4.2 Transmission Capacity

In this section we discuss the transmission capacity of OFDMA versus WCDMA for certain cases with high values of interference and finally come to the conclusion that OFDMA allows higher transmission capacity than WCDMA.

2.4.2.1 WCDMA Capacity

The Signal to Interference and Noise Ratio (SINR) in WCDMA technology for the signal received on n th multipath can be represented as,

$$\rho_n = P_n / (fP + \sum_{i=0, i \neq n}^{N-1} P_i + N_0) \quad (2.2)$$

Where P_n in eq. 2.2 is the power of received signal on n th multipath for cell of the concentration, f is the ratio of other cell signals to own cell signal. To make our analysis simple we assume that all power, P/N is equally divided into N multipath, eq. 2.2 can then be modified into,

$$\rho_n = P/N / (fP + (N - 1)P/N + N_0) \quad (2.3)$$

For further simplicity we consider that single user is using all resources in Time Division Multiplexing (TDM) and hence there is no interference considered amongst users in the same cell. Furthermore, we consider Maximum Ratio Combining (MRC) signals which are received at different paths, so the average SINR can be represented in below equation as,

$$\rho_{WCDMA} = \sum_{n=0}^{N-1} \rho_n = \sum_{n=0}^{N-1} (P/N / (fP + (N-1)P/N + N_0)) \quad (2.4)$$

By taking the summation, P/N becomes P as previously considered that all power is equally divided into N multipaths. After re-arranging, eq. 2.4 can be modified as,

$$\rho_{WCDMA} = P / (fP + (1 - 1/N)P + N_0) = \rho / (f\rho + (1 - 1/N)\rho + 1) \quad (2.5)$$

Considering eq. 2.5 for certain cases, when $N=1$, mean that there is single path and flat fading channel, eq. 2.5 can be simplified into,

$$\rho_{WCDMA} = P / fP + N_0 \quad (2.6)$$

For case, when N is very large, $N \gg 1$ then eq. 2.6 can be modified into,

$$\rho_{WCDMA} = \rho / \rho(f + 1) + N_0 \quad (2.7)$$

After computing the SINR of WCDMA, we can now find the capacity of WCDMA by the given equation below,

$$C_{WCDMA} = \log_2(1 + \rho_{WCDMA}) [b/s/Hz] \quad (2.8)$$

Where the bandwidth is considered to be 1 Hz.

2.4.2.2 OFDMA Capacity

With OFDMA, multipath fading does not affect the transmission due to the use of Cyclic Prefix (CP) and 1-tap equalization of the subcarriers of OFDMA signal. The only source of degradation is background noise and the interference from neighboring cells which occurs when users are at the edge of the cell. Using eq. 2.4 OFDMA SINR can be written as follows,

$$\rho_{OFDMA} = P/fP + N_0 \quad (2.9)$$

By considering a flat fading channel with no multipath for WCDMA case, the above equation for both OFDMA and WCDMA is the same. The capacity of OFDMA can be represented by the following equation,

$$C_{OFDMA} = \log_2(1 + P/(fP + N_0)) = \log_2(1 + \rho/(\rho f + 1)) [b/s/Hz] \quad (2.10)$$

Cyclic Prefix (CP) is also considered due to multipath fading, eq. 2.10 can be modified into,

$$C_{OFDMA} = (1 - \Delta/Ts) \cdot \log_2(1 + P/(fP + N_0)) = \log_2(1 + \rho/(\rho f + 1)) [b/s/Hz] \quad (2.11)$$

Where f is the ratio of other cell to own cell interference [9]. This value is greater for users at the edge of the cell. So the users at center of the cell get good SINR values in OFDMA access technique and hence better QoS is assured as compared to users at the edge of cell facing high interference from neighboring cells and hence poor QoS. Fig. 2 and Fig. 3 show the performance evaluation comparison of both access technologies for the SINR value of 10 dB and 0 dB respectively. Fig. 2 shows that the performance of OFDMA is better than WCDMA for cases when $N=2$, $N=4$ and very large value, when $N \gg 1$. **By increasing the number of multipaths, the WCDMA capacity is also decreasing as**

shown clearly in Fig. 2. We also notice that OFDMA capacity is degrading when interference from neighboring cells also increases, that is f the ratio component in eq. 2.11,

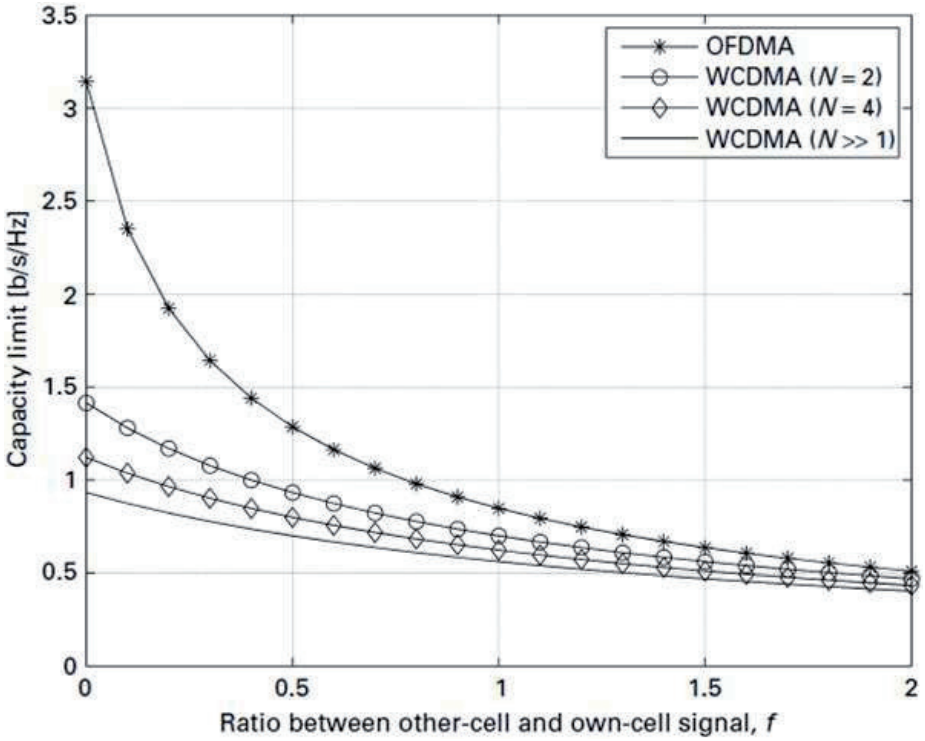

Figure 2. Capacity Performance Comparison: WCDMA versus OFDMA, SINR=10 dB

Fig. 3 shows the comparison which is carried out for SINR value of 0 dB. After clear observation the OFDMA allows better capacity as compared to WCDMA but the overall value is increased a little as compared to Fig. 2, where SINR value is 10 dB.

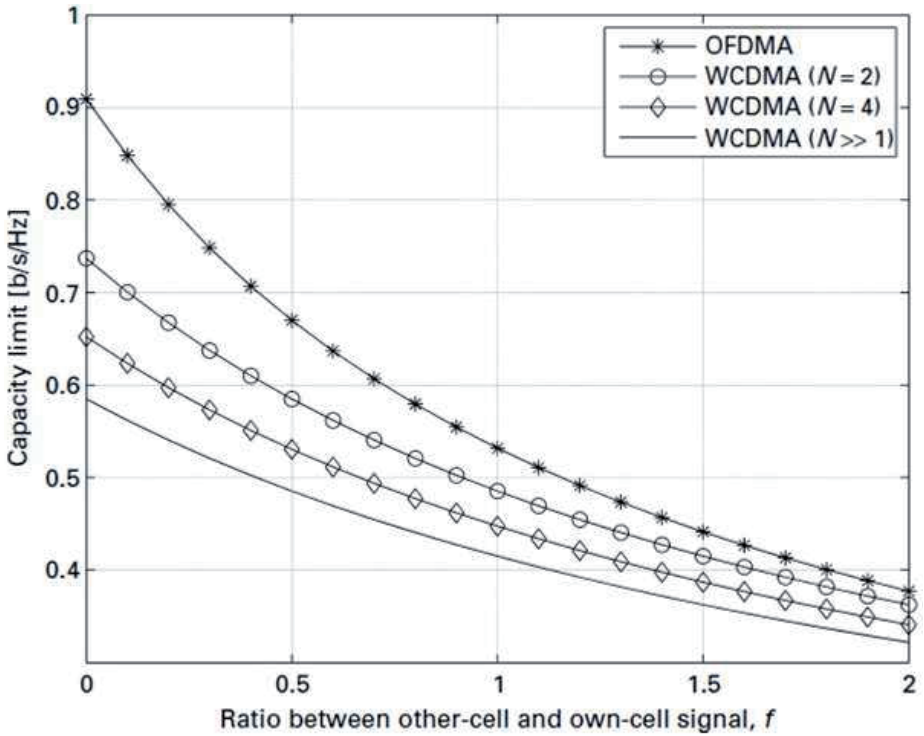

Figure 3. Capacity performance comparison: WCDMA versus OFDMA, SINR=0 dB

Table II summarizes the comparison of both WCDMA and OFDMA for different cases considered in previous sections. Table II shows that the gain is decreasing dramatically when the interference from neighboring cells increases, which is a point of concern for new technologies using OFDMA, specifically LTE system.

TABLE II

CAPACITY GAINS, OFDMA VERSUS WCDMA

		OFDMA gains over WCDMA		
	<i>f</i>	N = 2	N = 4	N >> 1
$\rho = 10\text{dB}$	0	122%	180%	237%
	1	21%	36%	51%
	2	9%	18%	27%
$\rho = 0\text{dB}$	0	23%	40%	55%
	1	10%	19%	28%
	2	4%	11%	17%

2.5 Evolution of 4G LTE Network

LTE Advance (LTE-A) is regarded as 4G Networks as it fulfills the ITU-R requirements for data rate and heterogeneity of networks. Table I shows the radio-interface attributes for LTE, UMB and WiMAX. All the three systems support flexible bandwidths, FDD/TDD duplexing, MIMO and OFDMA techniques in downlink. They are slightly different, like LTE uses SC-FDMA in its uplink while others use OFDMA in downlink and uplink as well. But still their performance is almost the same instead of these small differences [9]. The 4G-requirements for peak data rate is up to 1 Gbps in low mobility area and 100 Mbps in wide area network. Both 3GPP and IEEE 802 LMSC are developing their own standards in order to meet IMT-advanced technology, with the goal set in mind to achieve high data rates and high spectral efficiency with backward compatibility to earlier releases. Several more developments are discussed like support for larger than 20 MHz bandwidth and high order MIMO to meet IMT-advanced needs.

CHAPTER 3

THE FEMTOCELL SOLUTION SERVING INDOOR USERS

3.1 Indoor Traffic in Cellular Mobile Networks

This section will explain the main reasons behind the enormous growth of indoor data traffic and their impact on cellular systems.

3.1.1 Mobile Data Traffic

As already mentioned in chapter 1 that exponential growth of mobile data traffic is taking place in the next coming years as verified by Cisco System Inc.'s latest mobile data traffic growth forecast [4], [24]. It can be seen from (Appendix) that this growth is becoming double every year till 2014 [4], [24]. Introduction of new devices and their usage pattern is responsible for this growth. Most of this traffic is generating from indoor devices.

3.1.1.1 New Applications and Usage Pattern

Lately, the trend of using just music and peer-to-peer applications are shifting to video applications. Any video application requires a high volume of data and hence requires high network capacity. According to Cisco, 66% (Appendix) of world's mobile data traffic will be video by 2014 [4], [24]. The increasing demand for real-time and user-generated contents is the main reason for this shift. Among the top 12 sites on the Web (by ranking the traffic), two are the typical social networking sites and the remaining are directly or indirectly associated with the social networking sites [5], [24]. Their popularity has reached to such an extent that the device manufacturers and network operators are installing dedicated options to access them. In the beginning, these sites used to exchange only text based messages but now users have the provision to exchange rich multimedia contents. Therefore, it

is practical to assume that the traffic of social networking sites is playing a major role towards such growth of mobile data traffic.

3.1.1.2 Emergence of New Devices

The high capability of innovative devices play a vital role in paradigm shifts in application's usage on the mobile devices. The current mobile devices are equipped with high-resolution cameras. They contain higher processing power, data storage facility and multiple wireless connectivity. A usual e-reader was initially thought to consume text-only contents. But nowadays e-books or e-newspapers also contain rich multimedia contents. Lately iPad goes beyond these readers by supporting much additional functionalities. The large screen terminals such as personal computers are consuming the highest volume of wireless network capacity. It has been observed that a single laptop can generate as much traffic as 1300 basic-feature phones [4], [24]. Currently cellular operator's business model supports use of SIM cards (through USB modem) with Laptop or Netbook. It is seen that Laptops and Netbooks would alone contribute to 70% (Appendix) of all mobile data traffic by 2014 [4], [24].

3.1.2 Impact of Indoor Data Traffic

Paradigm shift of usage pattern of devices and applications is most likely occurring in indoor. Hence, it is quite logical to assume that the traffic generated from the indoor is contributing mostly to the overall increase of mobile data traffic. **A realistic experience shows that in mature market about 70% traffic is generated from the indoor users [6], [7].** This chapter introduces LTE technology and shows why serving indoor traffic from the macro network operating with LTE technology is not a useful solution. Later we introduce the LTE simulation environment to observe the impact of indoor traffic on network throughput.

3.1.2.1 Capacity Degradation in Indoor

The high bandwidth applications will most likely run on device located indoor. In order to carry this traffic by the mobile networks, outdoor base stations would have to penetrate the walls and windows to reach the users in indoor. The penetration loss through the obstacles depends on the number of materials and material of the building used. Generally it is taken to be 20 dB, another more important factor is the path loss which is directly proportional to the carrier frequency. Thus increasing frequency at outdoor base stations may not provide sufficient signal strength in indoor suitable for high bandwidth applications. In order to provide concrete evidence of this fact, we made a comparative analysis of the impact of the attenuation factor on the channel capacity at different frequency bands. To compute the capacity of the channel, we used Shannon's capacity formula [8], the capacity C of a system is defined as:

$$C = B \log_2(1 + P/N_o B) \quad (3.1)$$

Where B is the channel bandwidth, P is the signal power and N_o is noise level of the system. Eq. 3.1 is defined for free space. In order to find the indoor capacity extra loss factor has to be introduced. LTE system at 900 MHz, 1800 MHz, 2100 MHz and 2600 MHz is considered here. Indoor users are served by outdoor eNodeB so that to find the capacity both indoor and outdoor. Data from Table III can be used for the computation of capacity both at outdoor and indoor.

TABLE III

ASSUMED PARAMETERS IN LTE CAPACITY CALCULATION FOR INDOOR AND OUTDOOR
TRAFFIC

Cellular System	Available LTE Bandwidth/Operator (MHz)	Attenuation due to single concrete wall(dB)
LTE 900	5	12
LTE 1800	10	14
LTE 2100	15	17
LTE 2600	20	20

In order to simplify the complexity we assumed that the Signal to Noise Ratio (SNR) of LTE 900 system is 10 dB. The indoor capacity was computed assuming a single concrete wall between the transmitter and the receiver. The penetration loss will vary depending on the number of walls and material of the wall used. New SNR value is calculated for different bandwidth and for different penetration loss. Fig. 4 shows a simplified presentation of the relative capacity increase of LTE 1800, LTE 2100 and LTE 2600 systems compared with the capacity of LTE 900 system. It suggests that higher frequencies provide less capacity to indoor users despite the increase of bandwidth. As a result it may not be possible to provide high quality video streaming service in indoor using outdoor base station.

based on available bandwidth for one operator in that band

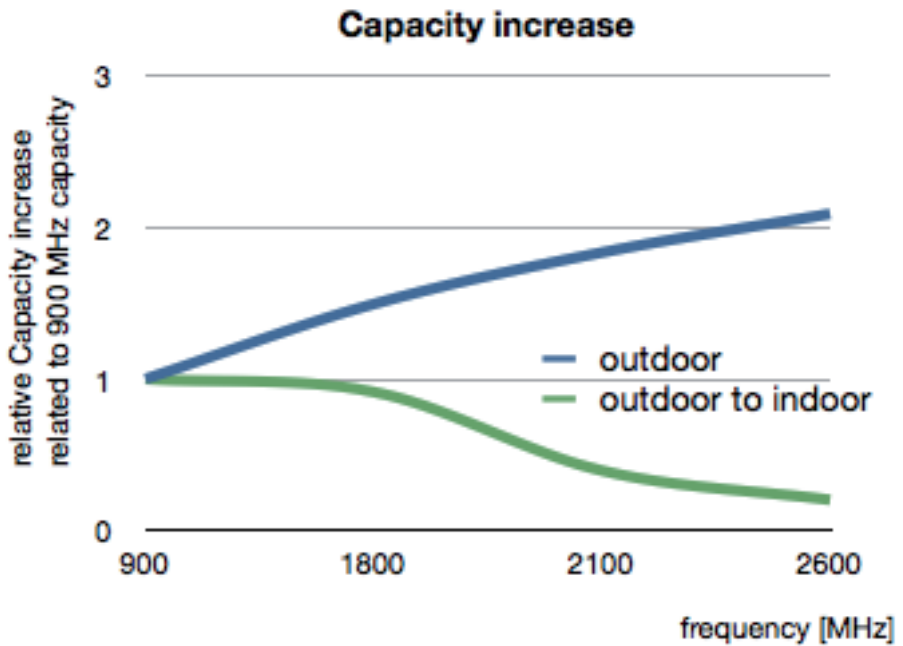

Figure 4. Relative Capacity in Indoor to Outdoor Scenario for LTE Network

3.1.3 WiFi Technology

WiFi refers to wireless communication standard IEEE 802.11 [16]. The most recent standard is IEEE 802.11n [17] which can provide peak data rate upto 75 Mbps. As there is high penetration of WiFi access points and WiFi enabled devices, WiFi can be an attractive solution for indoor traffic

offload for mobile operators. But WiFi works in unlicensed spectrum, has no independent voice service and there exist weakness in WiFi security protocol such as WPA2 [18].

3.2 Solutions for Efficient Service of Indoor Users

3.2.1 Femtocells

Femtocell can be defined as "a personal mobile network in a box" [19]. Femtocell uses a low power Femto Access Point (FAP) that utilizes fixed broadband connections to route femtocell traffic to cellular networks. Moreover, it is a part of self organizing network (SON) with zero touch installation. It supports limited number of active connections 3 or 4 but can be extended from 8 to 32. It is used to improve indoor signal strength as it avoids walls penetration loss. Femtocells can support indoor users with high signal strength and thus can offload these users from outdoor base stations. The main driver for user is improved coverage and capacity thus offers better quality of service not only to indoor users but also to outdoor users by offloading. Femtocell uses the licensed spectrum owned by a mobile operator. Smaller cells are typically used in homes and there is an option for enterprise femtocells. As femtocell can connect user's mobile phone with home network, it can be seen as true initiative for fixed mobile convergence.

3.2.1.1 Network Management with Femtocells

Femtocells can be utilized as a tool [19] which is offered to mobile operators to improve business cases:

- Network Savings:
 - deployed for indoor coverage to reduce cell site
 - offload macro network traffic, reduces Capital Expenditure (CapEx) and Operational Expenditure (OpEx)
 - deployed in phase, brings require capacity

- Customer Hold:
 - improved customer satisfaction
 - brings inventive value suggestion for households
- Compatible for next generation networks:
 - supports high frequencies e.g. LTE
 - provides high data rates e.g. LTE

Dense deployment of femtocells that use the same spectrum, accounts for interference, effecting the macro network performance. Security risk is also involved by using ethernet or ADSL home backhaul connection for routing the offloaded traffic to core network. Some of the Internet data plans charge extra for large bandwidth so operator asking for extra payment may not be easily acceptable for customers.

3.2.1.2 Business Impact on Operators

Usually price per volume of data traffic is lower than that of voice traffic, the cost of managing data dominated network will soon become unsustainable in future. It is because the revenues they generate can no longer support such a high growth of data traffic. The investment required for the expansion of data dominated network is higher than its voice dominated counterpart simply because of the enormous growth of data traffic. It has been observed already that mobile data traffic will be dominated by video traffic. **To give an example, an average length YouTube video can generate the same amount of traffic to the network as 500,000 short messaging service (SMS) do [7].**

CHAPTER 4

METHODOLOGY AND SIMULATOR DEVELOPMENT

4.1 Simulation Tools

The performance management of modern communication network is the key parameter from any operator's point of view for reviewing its Quality of Service (QoS) against its contestants. The performance of an existing network can be measured, but these measurements reflect only the current state of the network and do not consider the changes in behavior of applications and users, which are changing over time. Therefore network operators must constantly modify and improve the network time to time. However, changing a network to meet new goals is a very complex process and is difficult to be analyzed with theoretical point of view by using mathematical methods. One solution is to analyze the simulation with the help of any appropriate simulating tool. Simulation can be described as building a model of network under consideration, inside a computer and introducing traffic into that model. The computer then provides some statistical parameters as output and these results are then used by operator as basis for determining, what must be done to change the network. Two of the better options publically available are; OMNeT++ and MATLAB based LTE simulators, both of them are open source and widely used for network simulations. Our first choice was OMNeT++ but later due to some constraints specifically with LTE technology, we changed the simulator and chose LTE System Level Simulator developed in MATLAB for our simulation. Both are to be discussed in detail.

4.1.1 OMNeT++

OMNeT++, The name itself stands for Objective Modular Network Testbed in C++ is an object oriented modular discrete event network simulation framework. It has been publically available since

1997. It is an open source framework and can be used under the Academic public license. OMNeST is the commercially supported version of OMNeT++. It is using eclipse based environment [22]. An OMNeT++ model consists of hierarchically nested modules, the depth of modules is not limited. Modules communicate via messages passing through gates. Modules are fully implemented in C++, specifically made for large scale hierarchical simulation model. Modules can have parameters which are used for specific purpose like number of users in the network and so on. Simple modules are programmed in C++ and make use of simulation library. These simple modules can be grouped together to form complex compound module. Example of this hierarchical modules is shown in Fig 5. A network interface card, a compound module consisting of a simple module MAC and a compound module Phy. A module description consists of Network Description (.NED) language format and behaviour description C++. We can switch to any mode for defining and editing our modules. Another important file is initialization (.ini) file, all sort of simulations can be easily configured using ini. Interactive GUI: Tcl/Tk windowing, allows view what's happening and to modify parameters at run-time [22].

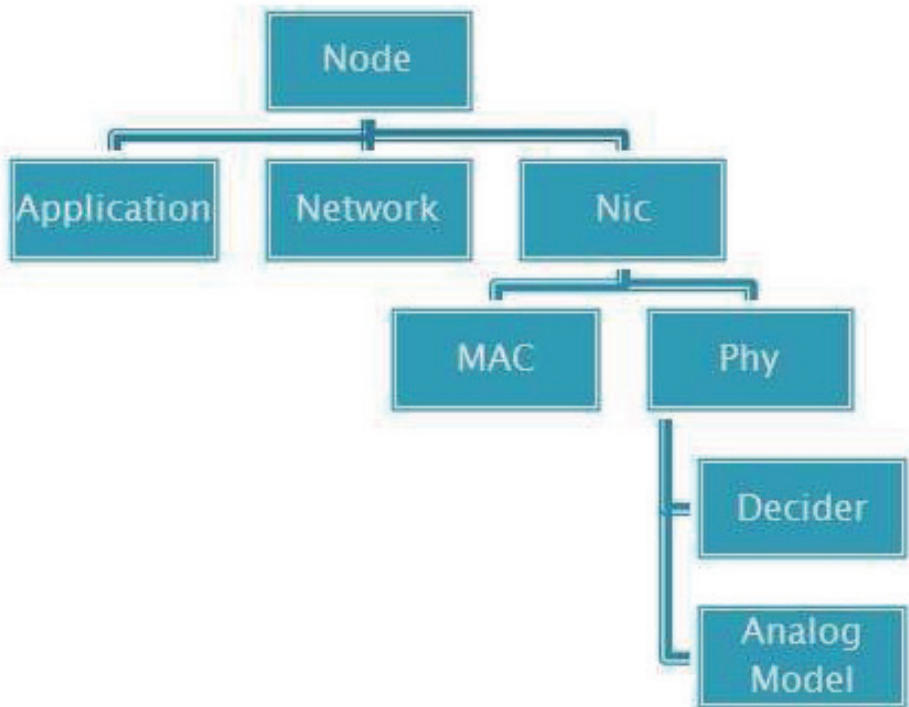

Figure 5. Sample format in OMNeT++ NED file

OMNeT++ simulation can be run under two interfaces, either command-line or graphical. In graphical interface user can monitor the network like what really happens in real time environment and can closely monitor every event.

4.1.1.1 Scope of OMNeT++

OMNeT++ can be used in the following types of networks.

- modeling of wired and wireless communication networks protocol
- modeling of queuing networks
- modeling of multiprocessors and other distributed hardware systems

In general, modeling and simulation of any system where discrete event approach is followed [22]. However, to accomplish this thesis work we need a simulator which is relevant to LTE system. While OMNeT++ yet doesn't have any support for LTE modules and developing those modules would be beyond the scope of our thesis work. Hence a MATLAB based LTE simulator, which is publically available, is used for the simulation.

4.1.2 MATLAB based LTE Simulators

In the development and standardization of LTE, as well as the implementation process of equipment manufacturers, simulations are necessary to test and optimize algorithms and procedures. This has to be performed on both, the physical layer (link-level) and in the network (system-level) context [10]. Both of them are made on the top of well known simulation software MATLAB.

4.1.2.1 LTE Link Level Simulator

Link level simulation deals with the investigation of issues such as MIMO gains, Adaptive Modulation and Coding (AMC) feedback, modeling of channel encoding and decoding or physical layer modeling for system-level. We are not going in the detail of link level simulator, as the physical layer attributes are directly feedbacked to the LTE system level simulator [10].

4.1.2.2 LTE System Level Simulator

The focus of System Level Simulation is more on network related issues such as scheduling, mobility handling and interference management [10].

4.1.2.2.1 Simulator Structure

Fig. 6 shows the schematic diagram of LTE system level simulator [10]. The core parts are link measurement model and link performance model. The link measurement model abstracts the measured link quality used for link adaptation and resource allocation. On the other hand the link performance model determines the link Block Error Ratio (BLER) at reduced complexity. As an output the simulator calculates throughput and Block Error Rate (BLER) in order to check the performance. The simulation is performed by defining a Region Of Interest (ROI) in which the eNodeBs and UEs are positioned. Length of simulation is measured in Transmission Time Intervals (TTIs).

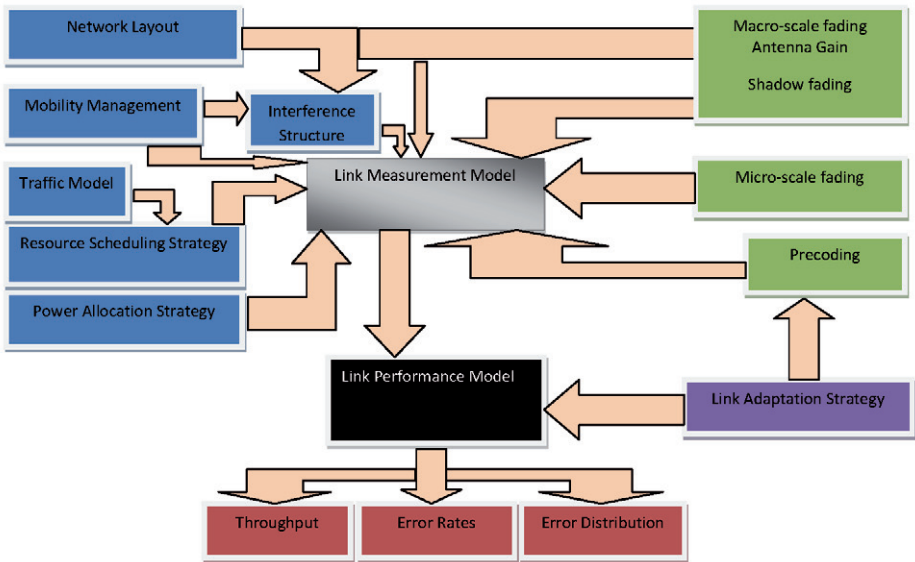

Figure 6. Schematic block diagram of LTE System Level Simulator [10].

Implementation-wise, the simulator flow executes in the following way. For each TTI the UE is moved when UE goes outside the ROI then UE are re-allocated randomly in the ROI. Every eNodeB receives a feedback after each feedback delay. For scheduling the UEs, simulator do the following tasks [10].

- channel state→link quality model→SINR
- SINR, Modulation and Coding Scheme (MCS)→link performance model→BLER
- Send UE feedback

Where "→" represents the data flow of the simulator. The macroscopic pathloss between an eNodeB's transceiver and UE is used to model the propagation pathloss by using the distance and the antenna gain. The Shadow fading is caused by the obstacles between the eNodeB and UE.

4.1.2.2.2 Simulator Development

In order to simulate indoor environment, we created building blocks of radius 10 meters. To compensate the signal absorption of the wall, extra indoor penetration loss is added to all the signals traversing the walls of the block. For the provision of better service to indoor users, femtocells are created and deployed within the block. The necessary parameters and details of scenarios for femtocells is part of our next chapter.

CHAPTER 5

PERFORMANCE EVALUATION

5.1 Simulation Scenarios for Performance Evaluation

The system level environment is built on top of LTE System Level Simulator provided by the Vienna University of Technology, Austria [10], [11] for real LTE usage scenario is set up in MATLAB. The Simulation uses *TS36942* with urban environment as macroscopic Pathloss model. *TS36942* [11], [15] is Technical Specification provided for the future development work within 3rd Generation Partnership Project (3GPP) for Evolved Universal Terrestrial Radio Access (E-UTRA) operation primarily with respect to the radio transmission and reception including the Radion Resource Management (RRM) aspects. Whereas log normally-distributed 2D space-correlated shadow fading with a mean value of 0 dB and standard deviation of 10 dB, shown in Fig. 7, as described by *Claussen* [11], [12] is used. The resolution of map is set to 5 meters/pixel. The algorithm also counts the number of neighbors which is fixed to 4 and 8, means 4 or 8 pixels from center of eNodeB. The correlation between sectors of site is fixed to 1, which means exactly the same pathloss map is generated for each sector of eNodeB. Correlation could either be 0 or 1, where 0 means absolutely different maps. Fast fading model [11], [13] is generated according to the speed of the user and the mode used for the transmission. The channel model type used is PedB, ITU pedestrian, it is the specification of link-level simulation, part of LTE Link Level Simulator, other options of channel model type are also available. The channel trace length in seconds could be chosen depending upon the available memory, as it will be loaded by the simulator for later use. The environment uses *Best Channel Quality Indicator (CQI)* scheduler for Physical Resource Blocks (PRBs) allocation. Other available options are *round robin*, *proportional fair*, as *proportional fair* has been tested and contains some bugs. *TS36.942*

antenna specification is used for eNodeBs in the simulation with a gain of 15dBi. Other options are also available, depending upon the environment and frequencies. Single Input Single Output (*SISO*) is used as the transmission mode. The SINR averaging algorithm, Exponential Effective Signal to Interference and Noise Ratio Mapping (EESM), other options could be Mutual Information Effective Signal to Interference and Noise Ratio Mapping (MIESM). The users are set according to Table IV [11], [14], [15]. The simulation is run for 200 Transmission Time Interval (TTIs). For detailed information we can see the documentation available within the simulator.

TABLE IV

BASIC PARAMETERS FOR LTE SIMULATION ENVIRONMENT

Parameter	Value
Frequency	2.0 GHz
Receiver noise figure	9 dB [14]
System Bandwidth	10MHz
Thermal noise density	-174 dBm/Hz
Lognormal Shadowing	10dB
Inter eNodeB distance	500m
UE Power	23dBm
Macroscopic pathloss	$128.1 + 37.6 \log_{10}(R)$ [15]
Number of UEs per sector	10
eNodeB TX Power	46 dBm [14]
Penetration Loss	20dB
UE speed	5 km/h
BS antenna gain	15 dBi [14]
Traffic type	Full buffer Traffic
Cell Layout	Hexagonal grid, 3sectors/eNodeB

Shadow fading, eNodeB 5 mean: -0.42 sd: 9.68

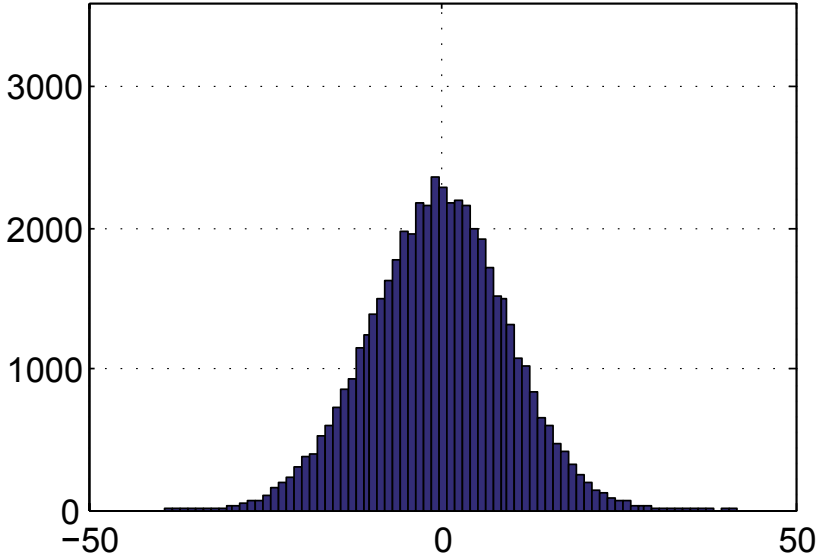

Figure 7. Shadow fading with mean of 0 dB and standard deviation of 10 dB

Two basic scenarios are considered, In first scenario, indoor users are being increased while no femtocells are deployed for indoor users to serve them and the performance of macrocells is evaluated. In the second case, femtocells are also deployed indoor and both performance of macro and femtocells are estimated. The basic simulation Parameters are set according to Table IV [11], [14], [15]. These parameters will remain the same for all simulation scenarios.

5.2 Scenario without the Deployment of Femtocells

Initially, when the simulation is run, users are randomly distributed in the whole macro network with 10 UEs per sector/cell. As described in previous chapter, indoor environment is created at the edge of cells and then UEs are taken indoors from these randomly distributed users. Worst case scenario is considered for indoor UEs which are at edge of the cells and facing an extra 20 dB indoor penetration loss. The users positions for 20% indoor and 90% indoor scenarios are shown in Fig. 8 and Fig. 9 respectively.

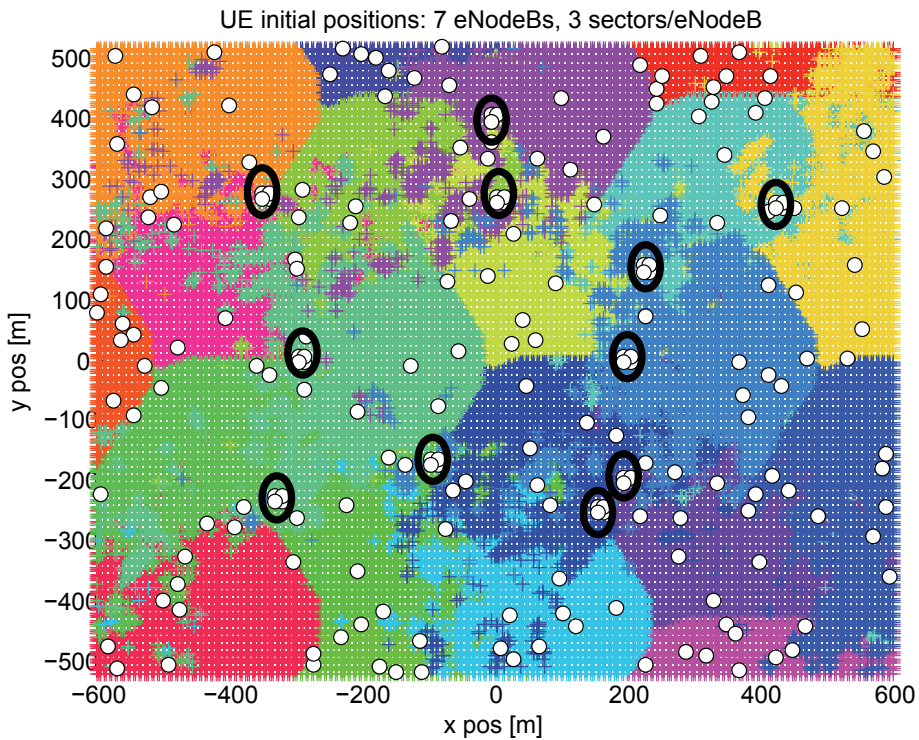

Figure 8. 20% indoor users with shadow fading map

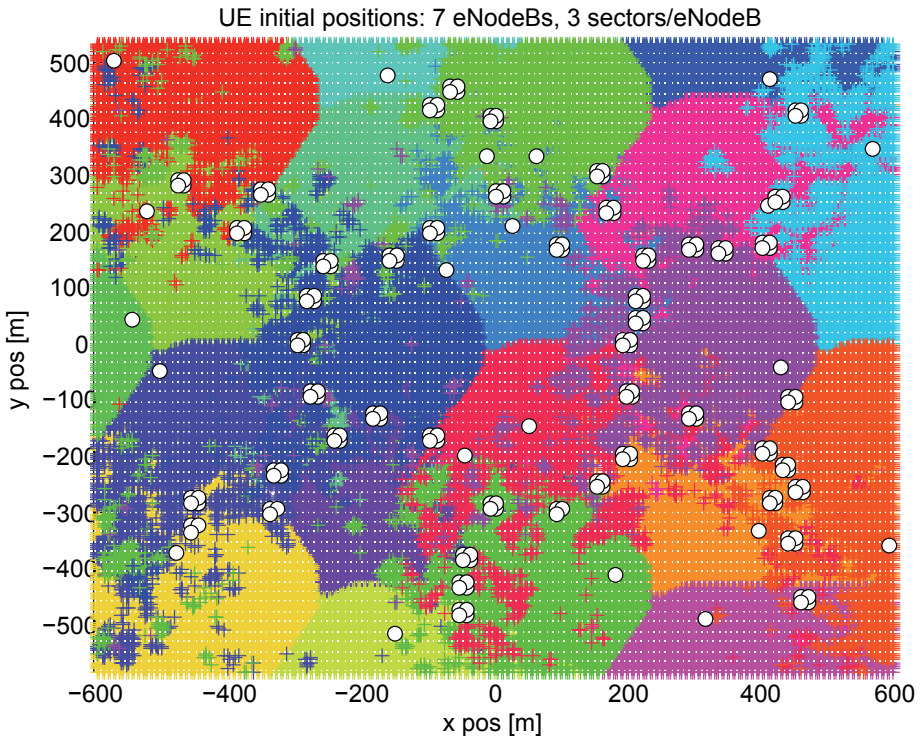

Figure 9. 90% indoor users with shadow fading map

For the sake of ease the 20% indoor users in Fig. 8 are marked with black circles. To see the impact of indoor users on throughput, indoor users are increased from 0% to 100% with a step increase of 10%. The resulting total aggregated macro network throughput is computed for 21 cells.

5.2.1 Simulation Results

The network layout shown in Fig. 10 consists of 7 eNodeBs each containing 3 sectors.

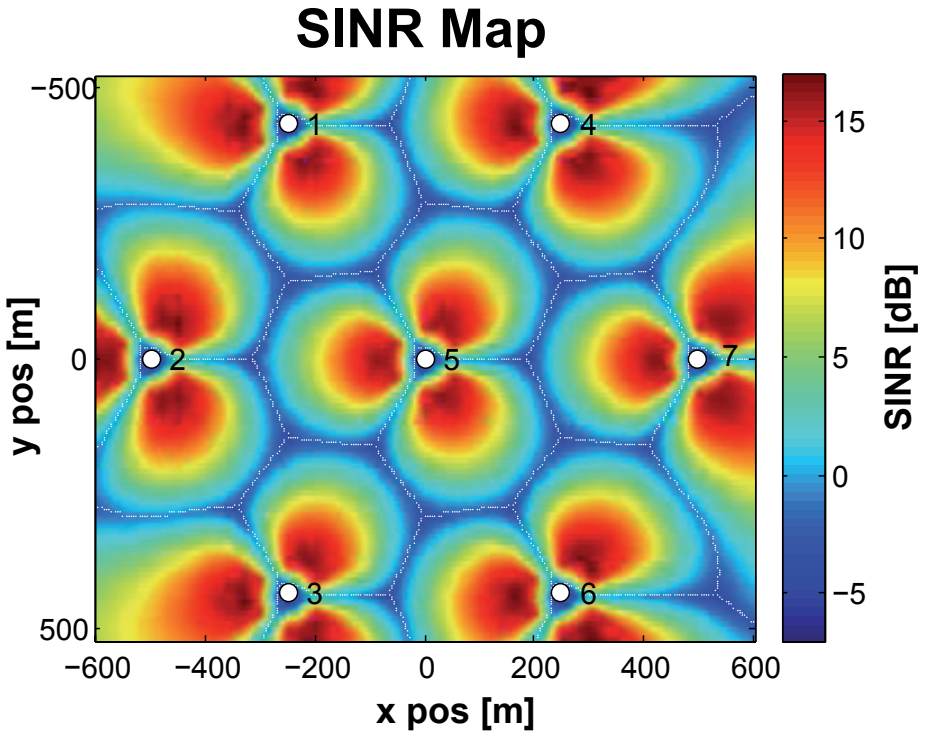

Figure 10. Network layout with pathloss, 7 eNodeBs with different SINR values

The SINR map after the application of pathloss as shown in Fig. 10 represents the distribution of SINR for the whole ROI. High SINR values, as expected, are observed in the region closer to the eNodeBs and hence excellent quality of service is assured for UEs present in this region. The value of SINR decreases with the increase in distance from eNodeB towards the edge due to increased pathloss and high interference from neighboring cells. To sum up, edge users experience poor SINR and hence poor quality of service. The total aggregated macro network throughput is plotted versus percentage increase of indoor users in Fig. 11(a). The results are only computed for downlink traffic. Throughput is computed using eq. 5.1.

$$\textit{Throughput} = \textit{Acknowledged data(bits)}/\textit{Time(s)} \quad (5.1)$$

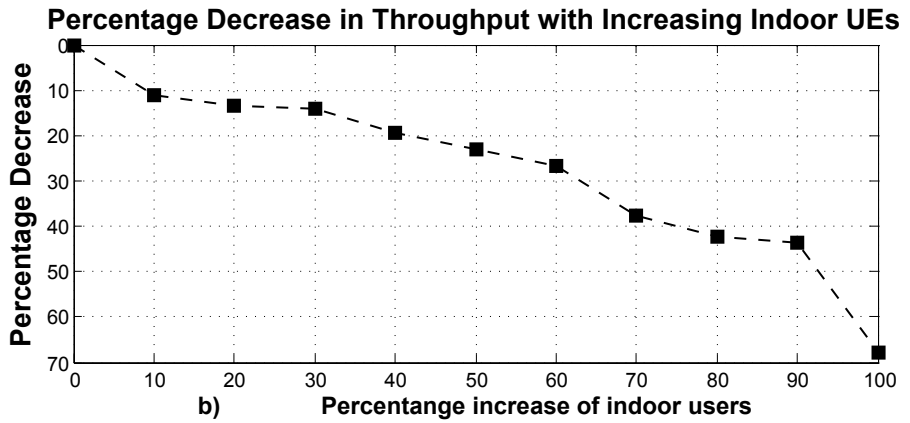
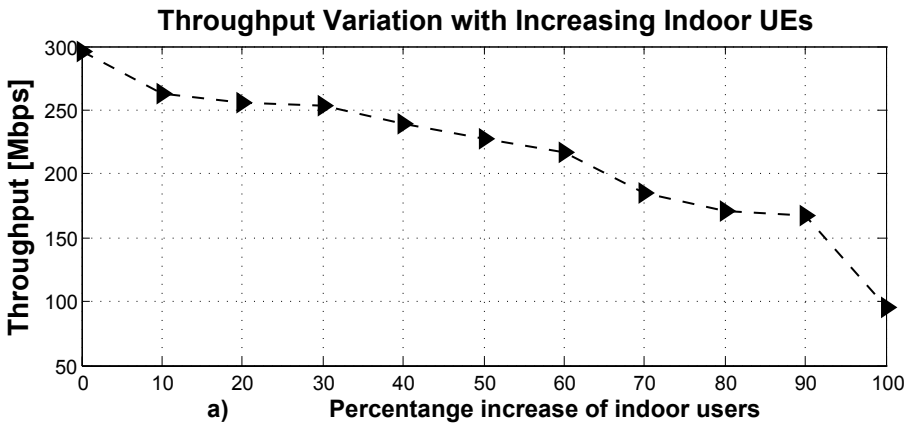

Figure 11. Decreasing throughput by increasing percentage of indoor UEs

As shown in Fig. 11(a), a clear degradation in downlink throughput of the total macro network is observed with increasing percentage of indoor users. This decreasing trend in the throughput is

in accordance with eq. 1 as the indoor users at the edge have lower SINR value shown in Fig. 10, which leads to the lower capacity and hence lower throughput. Fig. 11(b) represents the percentage decrease of total network throughput with percentage increase of indoor users. Currently the indoor traffic makes up about 70% (Appendix) of the overall traffic which in coming years is expected to increase and is the cause of the increased data volume. Statistically speaking, the behavior of the network around this percentage becomes hugely important. From Fig. 11(b) we observe a degradation of about 38% to 45% in the macro network throughput when the indoor users increase from 70% to 90%. From an operators point of view, almost half of the macro network throughput is lost due to indoor users which is a point of concern to meet quality of service requirements and to compete in the ever growing market.

5.3 Dense Deployment of Femtocells

Basic simulation parameters for femtocells are summarized in Table V. Femtocell is using single transceiver and its antenna gain is 5 dBi. One femtocell serves either 3 or 4 users [19]. The effective coverage of a femtocell is 10 meter in radius. The same setting is ensured for all femtocells. As previously mentioned that number of users per sector is 10 so total of 210 users exist in the whole macro network. We need a total of 53 femtocells in order to accommodate all the indoor users. Main parameters for femtocells are assigned according to Table V [11], [23].

TABLE V

BASIC PARAMETERS FOR FEMTOCELLS ENVIRONMENT

Parameter	Value
Frequency	2.0 GHz
Receiver noise figure	9 dB
System Bandwidth	10MHz
Thermal noise density	-174 dBm/Hz
Lognormal Shadowing	10dB
Cell Radius	10 m
UE Power	23dBm
Macroscopic pathloss	$128.1 + 37.6 \log_{10}(R)$
Average number of Users per Cell	3 OR 4
HeNB TX Power	21 dBm
Penetration Loss	20dB
UE speed	5 km/h
BS antenna gain	5 DBi
Traffic type	Full Buffer Traffic
Cell Layout	Circular cell, 1 sector/HeNB

5.3.1 Simulation Results

The total aggregated throughput of all femtocells is computed against the increased percentage of indoor users. It can be clearly seen from Fig. 12 that the aggregated throughput is increasing almost linearly with the increasing percentage of indoor users.

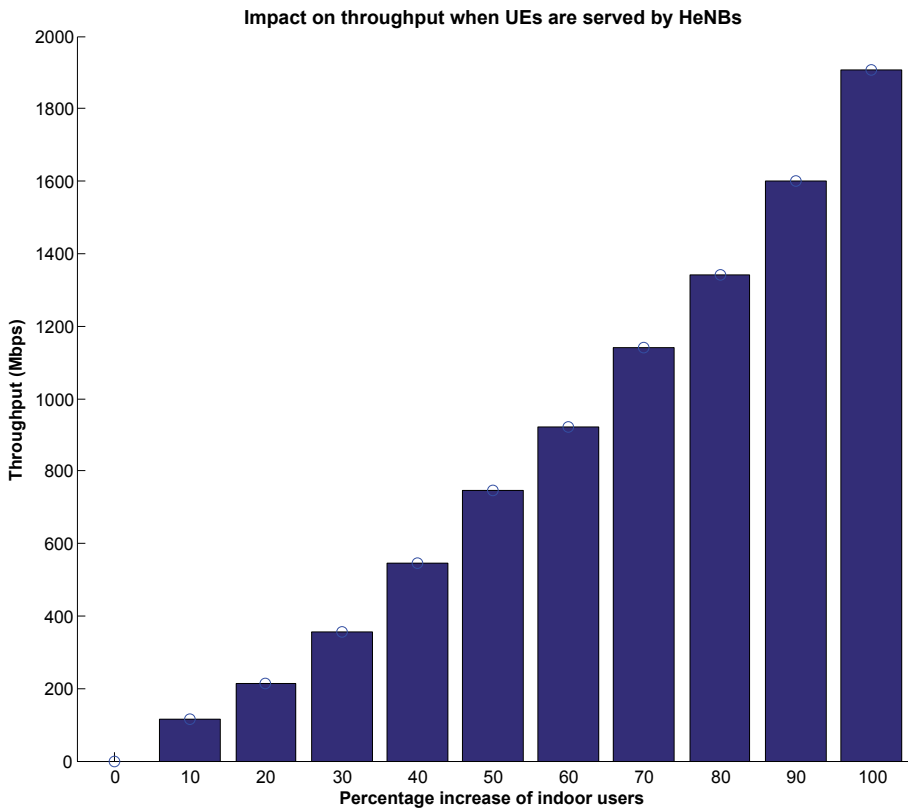

Figure 12. Increasing femtocells aggregated throughput by increasing percentage of indoor UEs

When more users move indoor, the traffic on macrocells offloads, this offloaded traffic is efficiently served by the operational femtocells, which results in getting maximum aggregated throughput. Hence better QoS is ensured. Comparing to our previous scenario, in the absence femtocells,

users were facing poor quality of signals from eNodeBs due to cell edge and extra indoor penetration loss of 20 dB so the aggregated throughput was also degraded.

Fig. 13 shows the comparison of macro network throughput with and without the deployment of femtocells against the percentage increase of indoor users. When number of users being moved indoor are increased, the total aggregated throughput of the macro network is also increasing. The reason is that now indoor users are being served by femtocells and getting good SINR by the serving femtocells. A clear difference in throughput is shown in first part of fig. 14 which is basically depicting the offloading behaviour of femtocells. Second part of the same figure is rather giving a clear picture and showing the increase in percentage. Here the maximum peak value of macro network throughput is 75% when the indoor users reach to 80%. The percentage increase or decrease shows the difference in general for evaluation purposes. The throughput is dropped to zero at 100% indoor users, showing that all users are moved indoor and now being served by femtocells.

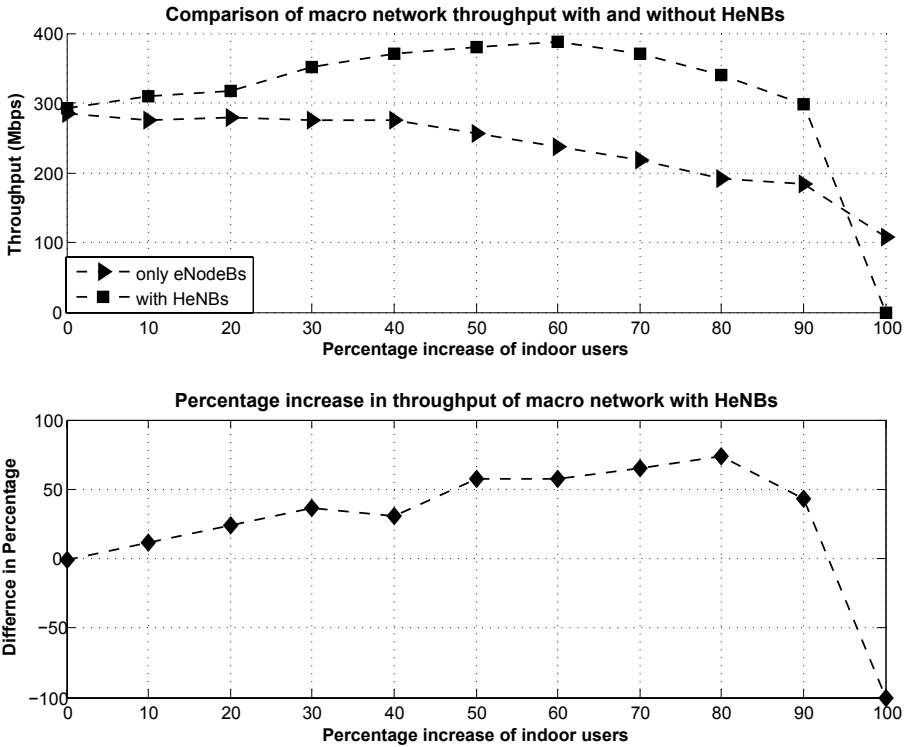

Figure 13. Comparison of macro network throughput; with and without femtocells

Fig. 14 summarizes a detailed comparison of macro network aggregated throughput for different percentage of indoor users. It basically shows the required number of operational femtocells for different percentage of indoor users which will effectively offload macro network traffic and leads to high aggregated macro network throughput. This sort of performance evaluation is highly important

from business model perspective to network operators. Operators need to know the effective number of operational femtocells required which effectively offload the increased traffic and to enhance the capacity performance of macrocells. Figure shows when a network contains 50% indoor users, the effective offloading takes place when to serve only 60% indoor users amongst them by femtocells instead of serving 100% indoor users. The effective offloading statistical value is different in case of 60% indoor users, where this value is 45%. Similarly for 70% indoor users, this value is 60%. Interesting point occurs for 80% indoor users for which the favourite value is 30% instead of 70% as for both the maximum throughput is almost the same, so the desired value for operators is to serve only 30%. Finally for 90% of indoor users, the offloading is effective when 60% of them are served by femtocells. In 100% indoor users's case the throughput drastically drops to 0 and shows that the macro network is underloaded and all users are now being served by femtocells.

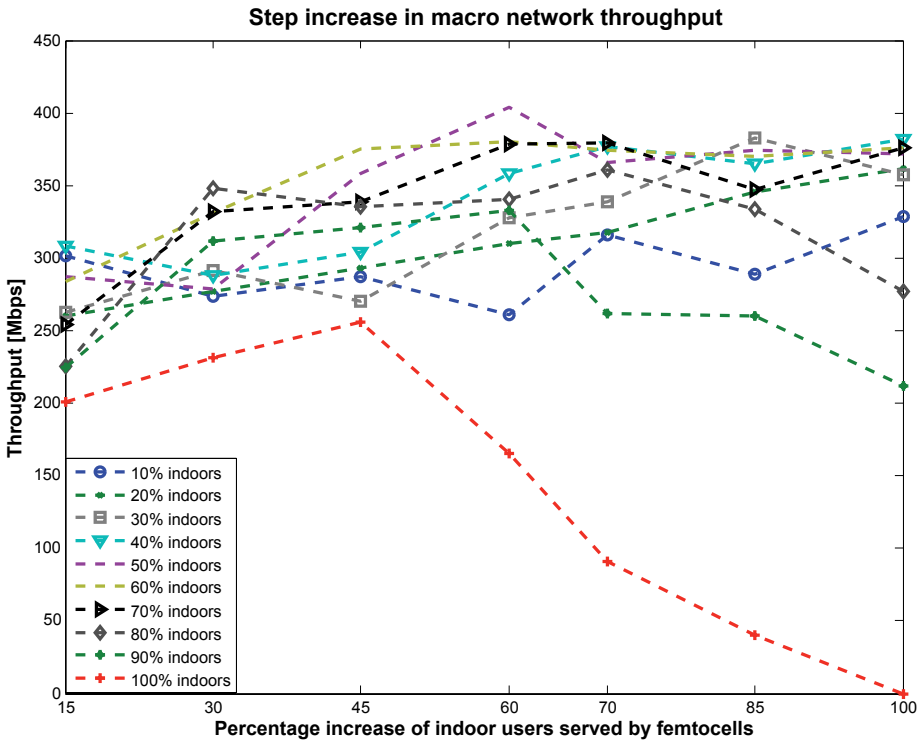

Figure 14. Effective offloading by femtocells for different percentage of indoor UEs

From Fig. 14 it is shown that indoor users in the range, from 15% to 40% do not show any drop after the peak value of throughput and show increase till 100% indoor users. This is because that macro network is not fully loaded by indoor users and the increase in traffic does not reach the threshold yet, which denies the fact of offloading nature. From previous analysis when there was no

femtocell, great degradation was observed when indoor users are in range, from 70% to 90%. Fig. 15 rather gives a clear picture of indoor users in the range from 50% to 100%.

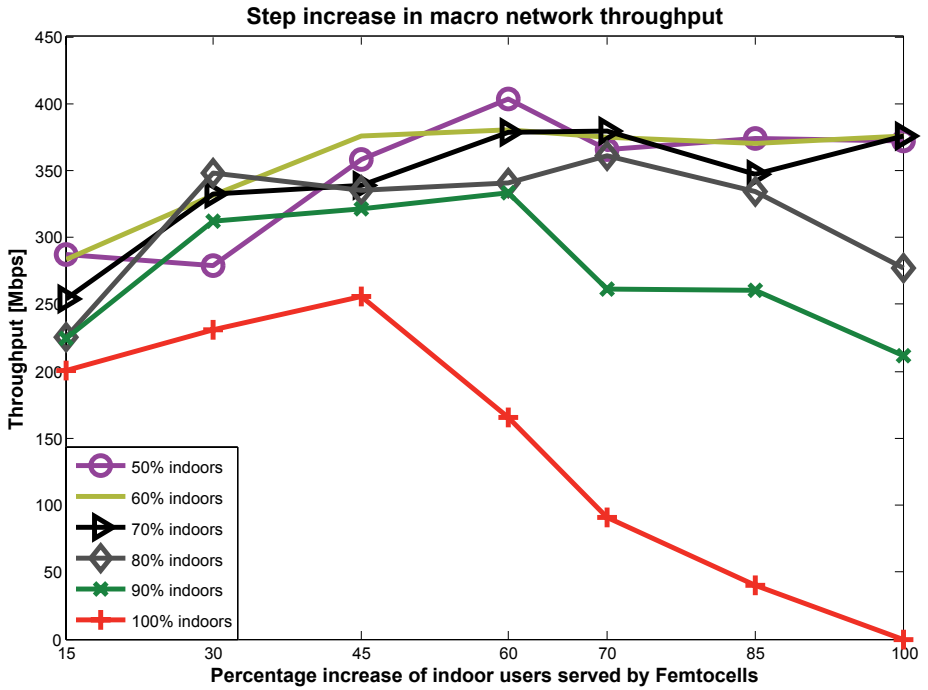

Figure 15. Effective offloading by femtocells (50% to 100% indoor UEs)

CHAPTER 6

FUTURE WORK AND CONCLUSION

Our analysis of LTE based network roll-out demonstrates that the macro network capacity drops by 44% for 90% of users being indoor. Talks with operators of the Norwegian LTE network have confirmed that this high amount of indoor users is very typical for LTE users. A further analysis needs to be performed in order to estimate the business perspective for mobile and fixed operators.

6.1 Conclusion

In order to meet the requirements of high bandwidth consuming applications and devices, paradigm shift towards high frequencies is foreseen. The increasing network traffic, whose most part is data traffic, is originating from the indoor. This explosive growth of indoor data traffic poses a big challenge for the operators in the mature market from capacity and quality of service point of view. Hence in order to sustain the quality of service requirements and ensure high data rates, offloading the indoor data traffic becomes a necessity. Deployment of Femtocells in this regard can surely be of great interest to both users and operators providing users with good quality of service and operators with low CapEx and OpEx while providing the high revenue.

6.2 Future Work

In future we expect to demonstrate the business impact of the mass deployment of indoor base stations. We would like to contribute also to develop a business model that motivates both the users and the mobile operators to go for a large scale deployment of indoor base stations. Another area of interest is to mitigate interference created by mass deployment of femtocells.

REFERENCES

1. *ITU sees 5 billion mobile subscribers globally in 2010*, press release, International Telecommunication Union, 15 February, 2010, Barcelona. http://www.itu.int/newsroom/press_releases/2010/06.html [accessed on 02 December, 2010].
2. Nokia Siemens Network, *Expanding horizons*, Volume 1/2010, pp. 19-21, ISSN 1797-2086.
3. Vegard Kjenner, *Mobile Broadband Taking Over?*(in Norwegian), Norwegian UMTS Forum, Feb 2010, <http://umts.no/index.aspx?pid=30&docid=63> [accessed on 02 December, 2010].
4. *Cisco Visual Networking Index: Global Mobile Data Traffic Forecast Update, 2009-2014*, White Paper, CISCO Systems Inc., 09 February 2010 http://www.cisco.com/en/US/solutions/collateral/ns341/ns525/ns537/ns705/ns827/white_paper_c11-520862.html [accessed on 04 December, 2010].
5. *The top 500 sites on the Web*, Alexa the Web Information Company.<http://www.alexa.com/topsites> [accessed on 05 December, 2010].
6. Mohammad M. R. Chowdhury, Josef Noll, *Collaborative Radio: Towards Sustainable Business in the Evolution of 4G*, in the proc. 6th Int. Conf. on Wireless and Mobile Comm., ICWMC, 20-25 Sep, 2010 - Valencia, Spain.

7. Rune Harald Rækken, *Femtocells for Wireless in the Home and Office*, Teletronikk, Issue 1.10, pp. 85-96.
8. Claude E. Shannon, *Communication in the Presence of Noise*, Proc. of the Instit. of Radio Engineers, vol. 37 (1):10-21.
9. Farooq Khan, *LTE for 4G Mobile Broadband, An Air Interface Technologies and Performance*, Cambridge University Press, New York City, 2009, p. 3.
10. J. C. Ikuno, M. Wrulich, and M. Rupp, *System level simulation of LTE networks*, in Proc. 2010 IEEE 71st Vehicular Tech. Conf., Taipei, Taiwan, May 2010.
11. J. C. Ikuno, *Dimensioning Vienna LTE Simulators System Level Simulator Documentation, v1.3r427*, Instit. of Comm. and Radio-Frequency Engg., Vienna Univ of Tech, Austria Gusshausstrasse 25/389, A-1040 Vienna, Austria, February, 2009. <http://www.nt.tuwien.ac.at/fileadmin/topics/simulators/LTEsystemDoc.pdf> [accessed on 01 November, 2010].
12. H. Claussen, *Efficient modeling of channel maps with correlated shadow fading in mobile radio systems*, IEEE 16th International Symposium Personal, Indoor and Mobile Radio Communication, PIMRC 2005, Sept. 2005, Berlin, pp. 512-516.
13. ITU-R, *Recommendation M.1225: Guidelines for evaluation of radio transmission technologies for IMT-2000*, Tech. Rep., 1997. www.itu.int/dms_pub/itu-r/oth/.../R0A0E00000C0001MSWE.doc [accessed on 03, November, 2010].

14. 3GPP, Tech Spec. Group RAN,E-UTRA; *LTE RF system scenarios*, Technical Report TS 36.942, 2008-2009.<http://www.3gpp.org/ftp/Specs/html-info/36942.htm> [accessed on 08 November, 2010].
15. 3GPP, *Physical layer aspects for E-UTRA*, Technical Report TS 25.814, 2006. <http://www.3gpp.org/ftp/Specs/html-info/25814.htm> [accessed on 08 November, 2010].
16. IEEE Standard Association, *IEEE 802.11: Wireless LAN Medium Access Control (MAC) and Physical Layer (PHY) Specifications*, (2007 revision), 12 June, 2007. <http://standards.ieee.org/getieee802/download/802.11-2007.pdf> [accessed on 20 November, 2010].
17. IEEE Standard Association, *IEEE 802.11n-2009-Amendment 5: Enhancement for Higher Throughput*, 29 October 2009. <http://standards.ieee.org/getieee802/download/802.11n-2009.pdf> [accessed on 25 November, 2010].
18. Sohail Ahmad, *WPA Too!*, presentation, Black Hat USA 2010. <http://www.airtightnetworks.com/fileadmin/pdf/WPA-Too-Hole196-Defcon18-Presentation.pdf> [accessed on 30 November, 2010].
19. Jean-Baptiste Vezin, *Femtocell, a key element in Mobile Broadband*, A presentation, 17 November. <http://www.blooble.com/broadband-presentations/presentations?itemid=3602> [accessed on 5 December, 2010].

20. Chang, R.W., Synthesis of band-limited orthogonal signals for multichannel data transmission, *Bell Systems Technical Journal*, vol. 45, pp. 17751796, Dec. 1966.
21. Saltzberg, B., Performance of an efficient parallel data transmission system, *IEEE Transactions on Communications*, vol. COM-15, no. 6, pp. 805811, Dec. 1967.
22. Andrs Varga, *OMNeT++ Discrete Event Simulation System*, User Manual, December 16, 2004.<http://sce.uhcl.edu/yang/public/download/OMNET++.pdf> [accessed on 25 September, 2010].
23. Yong Bai, Juejia Zhou, Lan Chen, *Hybrid Spectrum Usage for Overlaying LTE Macrocell and Femtocell*, 28th IEEE conference on Global telecommunications, 2009. <http://202.194.20.8/proc/GLOBECOM2009/DATA/PID965287.PDF> [accessed on 15 November, 2010].
24. Mohammad M. R. Chowdhury, Josef Noll, *On the Impact of Indoor Data Traffic in Mobile Networks*, Wireless World Research Forum (WWRF) #25, Kingston, UK, 16.-18. November 2010. <http://wiki.unik.no/index.php/Communications/HomePage?action=download&upname=201011Indoor-Mushfiq.pdf> [accessed on 28 November, 2010].

APPENDICES

APPENDIX

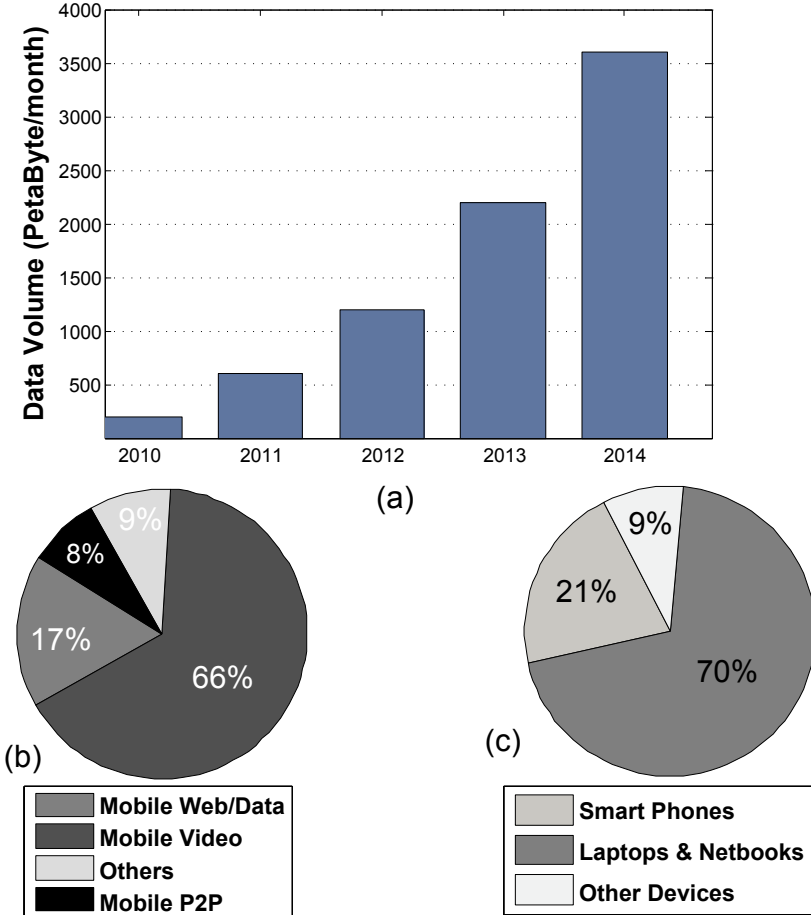

Figure 16. (a) Growth of mobile data traffic volume, (b) Contribution to mobile data traffic in 2014 (based on application type), (c) Contribution to mobile data traffic in 2014 (based on device type) [24].



MoreBooks!
publishing



yes i want morebooks!

Buy your books fast and straightforward online - at one of world's fastest growing online book stores! Environmentally sound due to Print-on-Demand technologies.

Buy your books online at

www.get-morebooks.com

Kaufen Sie Ihre Bücher schnell und unkompliziert online – auf einer der am schnellsten wachsenden Buchhandelsplattformen weltweit! Dank Print-On-Demand umwelt- und ressourcenschonend produziert.

Bücher schneller online kaufen

www.morebooks.de



VDM Verlagsservicegesellschaft mbH

Heinrich-Böcking-Str. 6-8
D - 66121 Saarbrücken

Telefon: +49 681 3720 174
Telefax: +49 681 3720 1749

info@vdm-vsg.de
www.vdm-vsg.de

