



# UNIK4230: Mobile Communications

## Spring Semester, 2013

**Abul Kaosher**

[abul.kaosher@nsn.com](mailto:abul.kaosher@nsn.com)

Mobile: 99 27 10 19

# Tentative lecture schedule

- ❑ 24. Jan. 2012 Introduction
- ❑ 31. Jan. 2012 Network Architecture and Functionality
- ❑ 07. Feb. 2012 Propagation Characteristics of Wireless Channel-I
- ❑ 14. Feb. 2012 Propagation Characteristics of Wireless Channel-II
- ❑ 21. Feb. 2012 Winter break
- ❑ 28. Feb. 2012 Combating the effect of Fading in Mobile Systems
- ❑ 07. Mar. 2012 Cell and Cellular Traffic-I
- ❑ 14. Mar. 2012 Cell and Cellular Traffic-II
- ❑ 21. Mar. 2012 Multiple Access
- ❑ 28. Mar. 2012 Easter holiday
- ❑ 04. April. 2012 Students Seminar on selected topics (All)
- ❑ 11. April. 2012 Mobile Broadband-I (Market Trends, Evolution, LTE)
- ❑ 18. April. 2012 Mobile Broadband-II (LTE, SON, QoS, LTE-A)
- ❑ 25. April. 2012 Refarming and the challenges of Mobile Communications, 700 MHz - 2.6 GHz as well as technology focus with LTE, 3G (HSPA)
- ❑ 02. May. 2012 Small Cell and Heterogeneous Network (HetNet)
- ❑ 16. May 2012 Repetition and walk through on the course including Exam guidance

# Reference literature & examination

Lecture slides (will be uploaded before lectures)

## Book

- P. M. Shankar, *Introduction to Wireless Systems*, 2002, Wiley.
  - Syllabus: chapter 2, 3, 4, 5 & 6
  - Do you need a copy of the chapters?
- Harri Holma and Antti Toskala, *LTE for UMTS. Evolution to LTE-Advanced*. 2nd Edition.

## Articles

- Will be provided during lectures (when necessary)

## Examination type:

- Oral examination (based on lecture slides, chapters of the course book, articles provided during lectures); if book chapter discusses more, contents in the lecture slide will limit the syllabus; however, lecture slides may contain more topics than the book chapter. In that case, follow the extra topics only from the slides and the articles (if given).

## Assignments

- Presentation on selected topics

# Introduction

**Date: 24.01.2013**

# Importance of Telecommunication

## Telekom er viktigere enn strøm og vei

Jeg ble veldig overrasket da jeg forsto for første gang at telekommunikasjon er viktigere enn strøm og vei. Vi kan klare oss uten strøm og vei, men telekom kan vi ikke klare oss uten.

**-Torstein Olsen**, direktør i Post- og teletilsynet informerte

-Source: dn.no. Publisert: 13.01.2012 - 16:40 Oppdatert

# Importance of Telecommunication

- Mobile Communications industry contributes to between 3.7 percent and 6.2 percent of GDP in the Telenor markets in Bangladesh, Pakistan, Thailand, Serbia and Ukraine.
- An increase of 10 percent in mobile penetration will boost the annual economic growth rate of a developing country by 1.2 percent.

according to a study by Deloitte for Telenor in Bangladesh, Pakistan, Thailand, Serbia and Ukraine in 2008

# Agenda

- What is mobile communication?
- History and trends
- Elements in mobile communication systems
- Basic functionality

# Agenda

- What is mobile communication?
- History and trends
- Elements in mobile communication systems
- Basic functionality



# What is mobile communication?

- Mobile communication system allows communication to and from handheld terminals during movement
- The system can handle a large number of users and provides almost a continuous coverage in a large geographical area
- Base station provides an area coverage
- The system has underlying infrastructure that provides communication to/from other type of communication networks

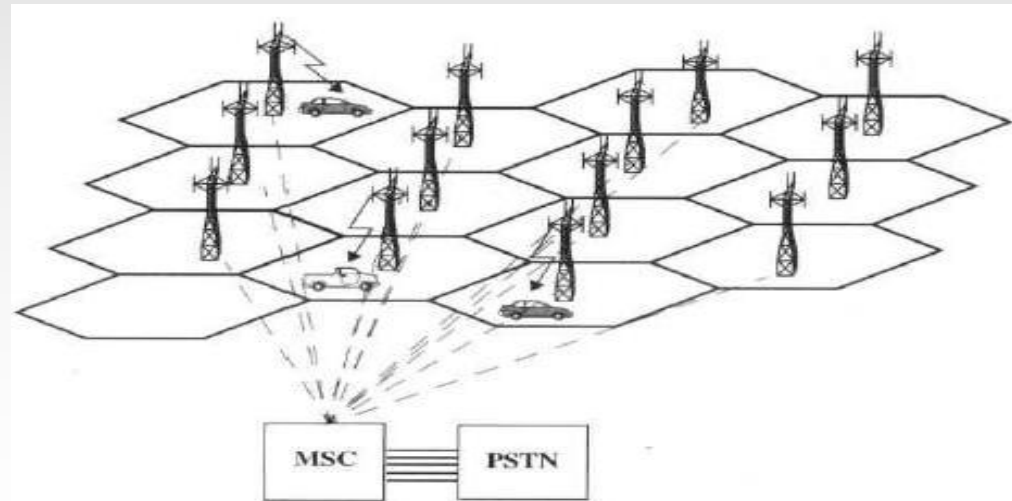

# Mobile Communication

- Mobile Device is most personalized device
- Voice, SMS
- Data/Internet
- Emergency (police, ambulance, fire)
- Payment
- M2M communication
- Entertainment (music, gaming)
- Social Network and life

# Generations in Mobile communication

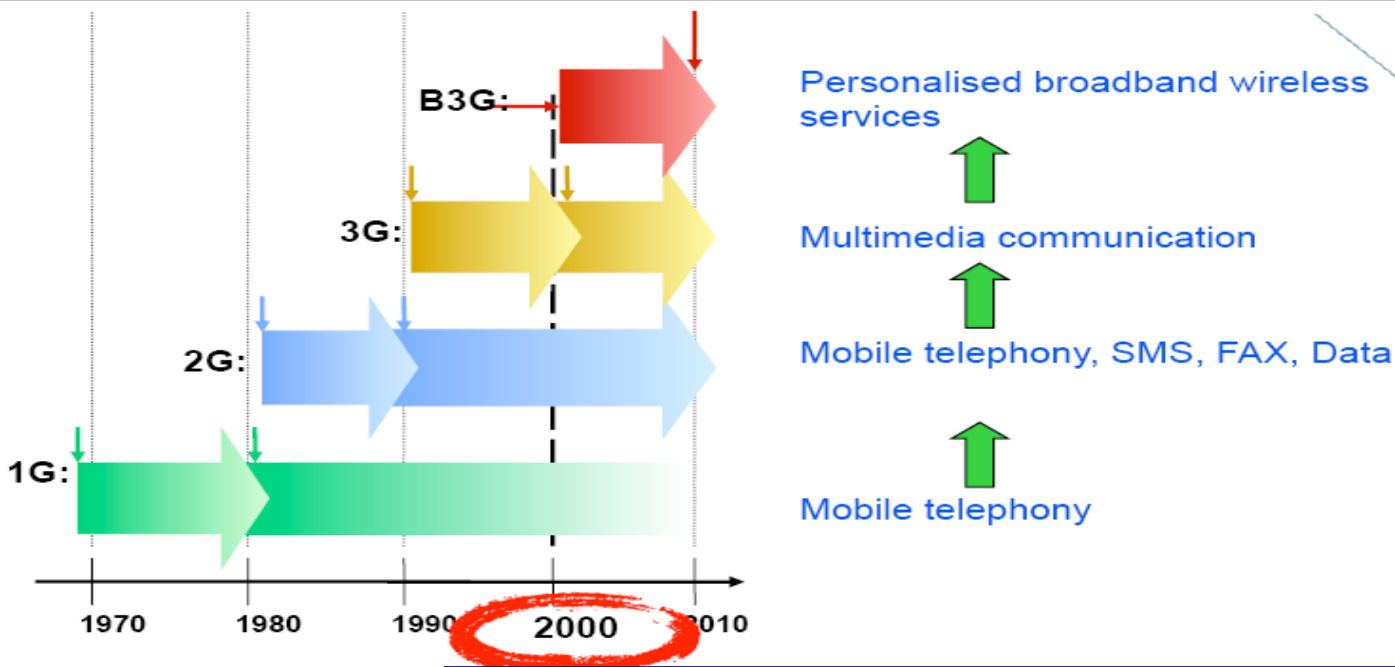

Original: B3G study, Jan 2001

## 4G

100 Mbit/s for high mobility communication  
1 Gbit/s low mobility communication  
LTE wont fulfill ITU-R requirements  
Candidate: LTE-A  
Service e.g. Mobile broadband

## 1G

Analog communication  
Only voice  
e.g NMT-450, AMPS

## 2G

Digital communication  
Mostly voice service, data service limited and low speed  
e.g. GSM

## 3G

Simultaneous voice and data  
peak data rate at least 200 kbps (IMT-2000 specs.)  
Latest UMTS release HSPA+ (Evolved HSPS): upto 84Mbit/s (DL), upto 22 Mbit/s (UL) -> 3.75G?

# Generations in Mobile Communications

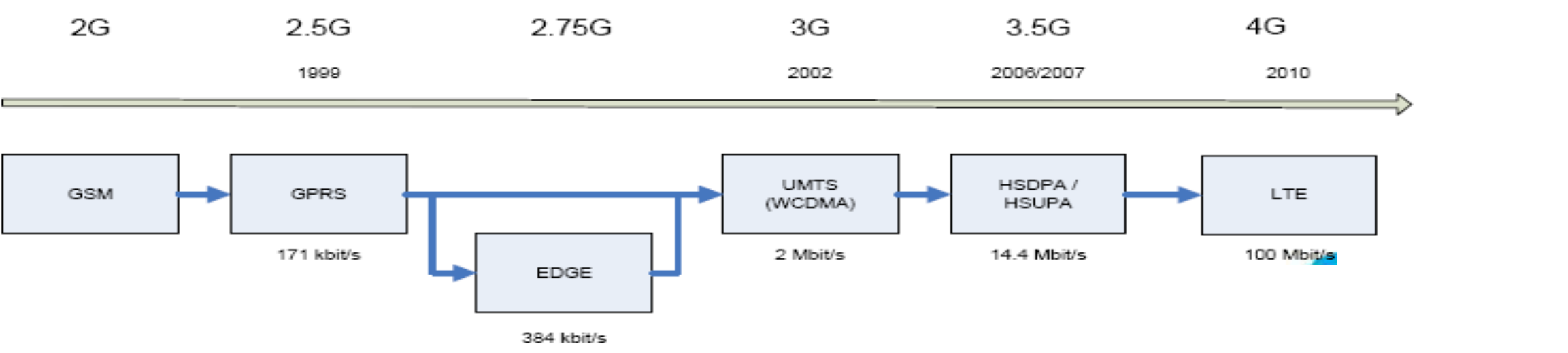

# Generations in Mobile Communications

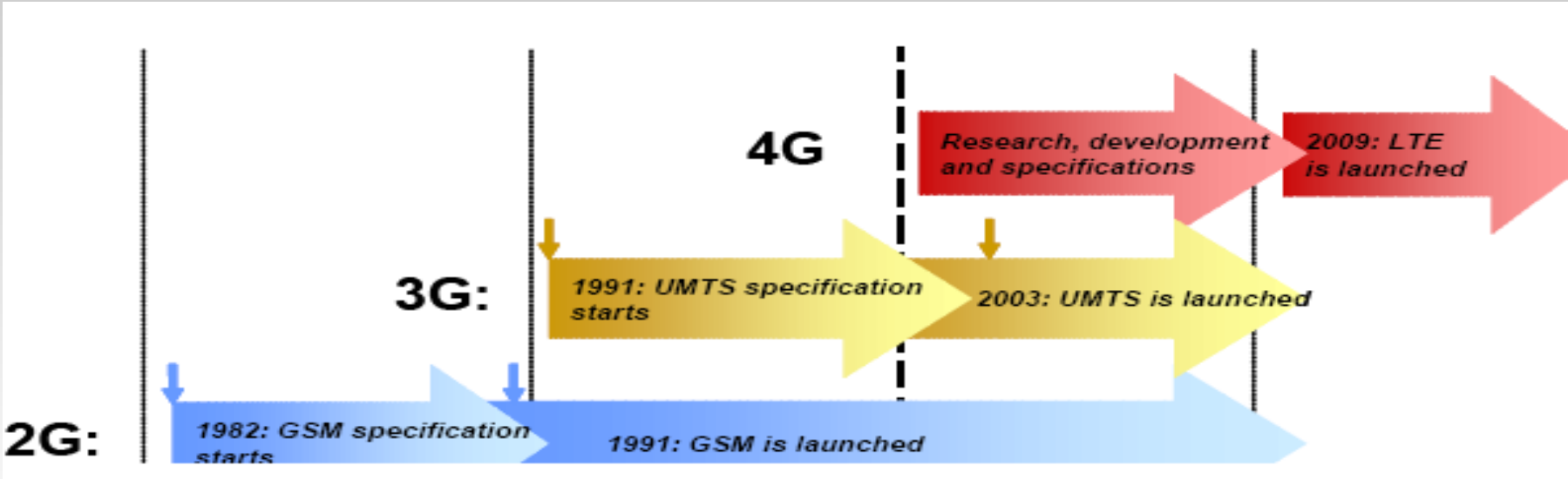

# Frequency band, technologies & operators

	<b>Frekvens- bånd</b>	<b>Total mengde tilgjengelig</b>	<b>Bruk i Norge (forventet bruk)</b>	<b>Aktører i Norge</b>
450 MHz	<b>453-457 463-467</b>	<b>2*4 MHz</b>	<b>CDMA</b>	<b>"ICE"</b>
DD (800 MHz)	<b>790-820 832-862</b>	<b>2*30 MHz</b>	<b>(LTE)</b>	<b>(frekvenser ikke delt ut)</b>
900 MHz	<b>880-915 925-960</b>	<b>2*35 MHz</b>	<b>GSM</b>	<b>Netcom/ Telenor</b>
1800 MHz	<b>1710-1805 1805-1880</b>	<b>2*75 MHz</b>	<b>GSM</b>	<b>Netcom/ Telenor/ Network Norway</b>
2100 MHz	<b>1920-1980 2110-2190</b>	<b>2*60 MHz</b>	<b>UMTS</b>	<b>Netcom/ Telenor</b>
2600 MHz	<b>2500-2570 2620-2690</b>	<b>2*70 MHz</b>	<b>LTE</b>	<b>Netcom</b>



# Agenda

- What is mobile communication?
- **History and trends**
- Elements in mobile communication systems
- Basic functionality

# History: Bell lab was testing mobile radio telephone in 1924



© Bell Labs



# History

- According to Bell Labs, on June 17, 1946, the first mobile telephone call was placed in St. Louis, Missouri from a telephone set installed in an automobile.
- In 1947 AT&T introduced **Mobile Telephone Service (MTS)**. Extended to 100 towns and highway corridors by 1948.
  - Only 5,000 customers placing about 30,000 calls each week. Calls were set up manually by an operator and the user had to depress a button on the handset to talk and release the button to listen.
  - 3 radio channels were available and hence 3 persons in any given city could make mobile telephone calls at one time
- In 1965 AT&T introduced **Improved Mobile Telephone Service (IMTS)**.
  - more simultaneous calls in a given geographic area, customer dialing, eliminating manual call set by an operator, and reduced the size and weight of the subscriber equipment

# History: Cellular principle

- In December 1947, Douglas H. Ring and W. Rae Young of Bell Labs, proposed hexagonal cells for mobile phones in vehicles.
- No technology was available to implement those until 1960
- There were no continuity of services between several cells in that early implementation
- The concept of *frequency reuse* and *handoff* was introduced later in 1970's.

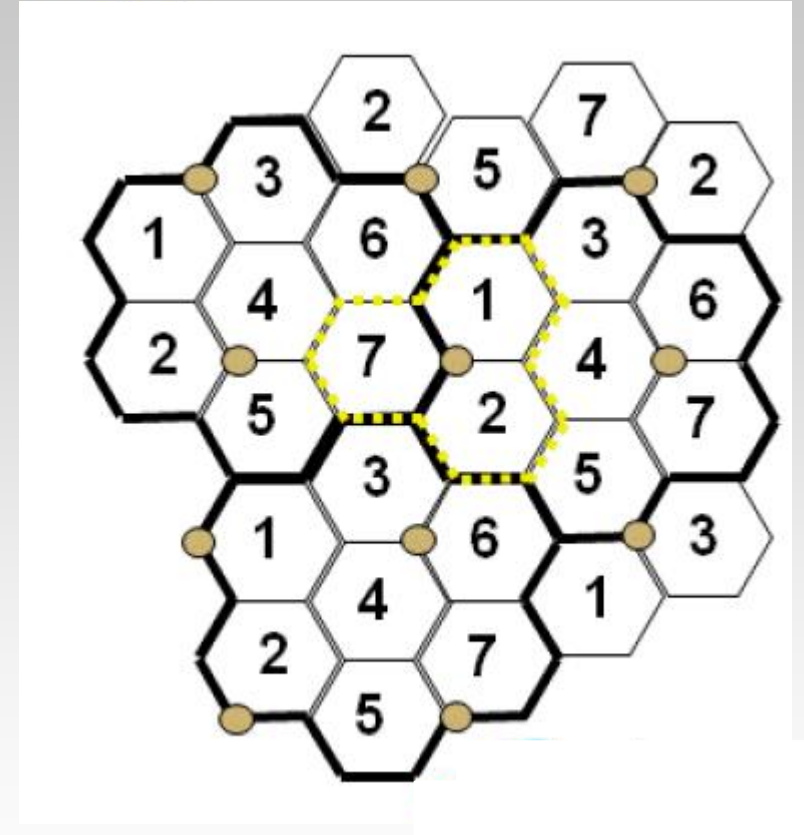

# History- NMT

- NMT was first tested in Stockholm between 1975-1979
- In October 1981, Nordic countries (Norway, Sweden, Denmark, Finland, Iceland) opened NMT network with automatic roaming between countries
- In Norway 250-300 BTS were expected to provide land coverage
- Initially capacity was 35000 subscriber that could be increased to 140000
- The first mobile phone weighed about 17 kg and cost was 35000 kr!



# History- NMT

- In 1984 NMT started facing capacity problem
- In 1986 NMT-450 had 87000 subscription in Norway
- To increase capacity, NMT later rolled out NMT 900 MHz band
- In 1995, two years after the start of GSM, NMT subscriber number peaked and there were 488 000 NMT subscribers in Norway
- Finally NMT were laid down in 2005, a month after 3G network was opened in Norway

# History- GSM

- In 1982, the Conference of European Posts and Telegraphs (CEPT) formed an Groupe Spécial Mobile (GSM) study group to develop a pan-European public land mobile system
- In 1987, 15 representatives from 13 European countries signed a memorandum of understanding to develop and deploy a common cellular telephone system
- In 1990, the Phase I of the GSM specifications for voice and Short Messaging Services (SMS) were published by ETSI
- In 1991, First commercial network launched by Radiolinja (Elisa Finland)



1991: Radiolinja (now Elisa) the first GSM Network in Finland. Mr. Harri Holkeri, then prime minister of Finland made the first GSM call.

# History- GSM

1993: Tele-Mobil (Telenor Mobil) and NetCom GSM opens their networks in Norway

1998: GSM 1800 starts operation to increase the network capacity in cities in Norway

2001: GPRS service started by Telenor Mobil

2004: EDGE Service started in Norway

2003: First 3G service in Europe

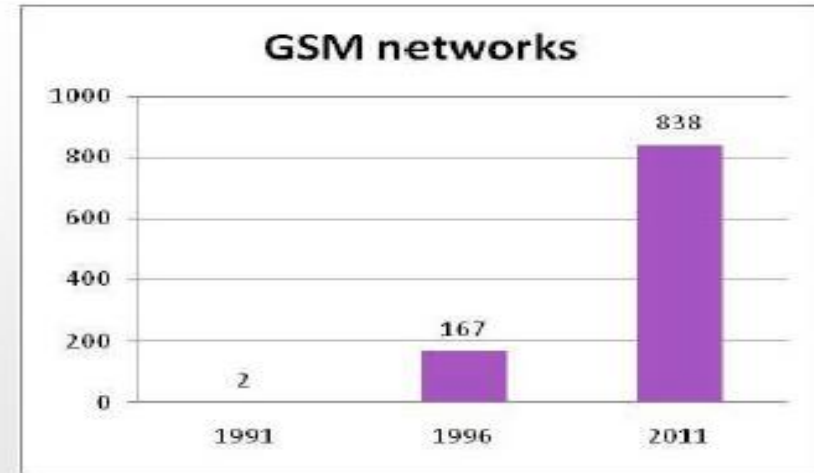
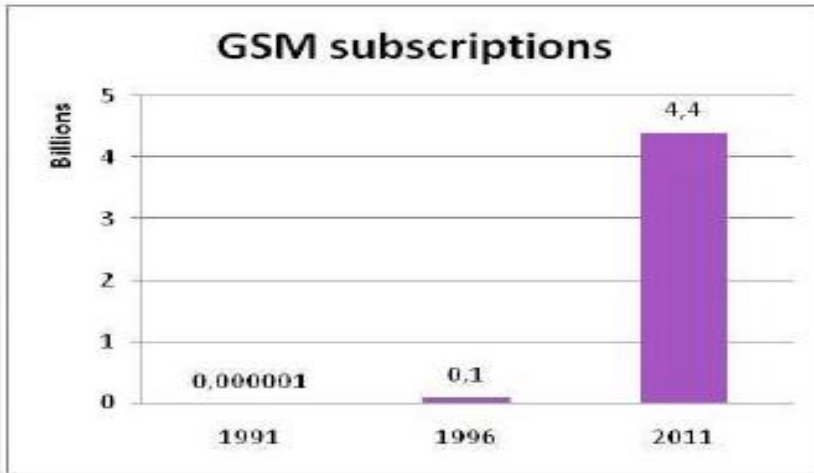

# Regulation & standardization

National & International regulators decide to use different frequency band for different applications. The most important regulatory bodies are:

- Post & Telecommunication Authority, regulatory authority in Norway
- CEPT (Conference of European Post and Telecommunications Administrations)
- ITU-R (International Telecommunication Union – Radio Communication), international regulatory authority arrange WRC (World Radio Communication Conference)

Standard organizations develop and adopt international standards for telecommunication systems, most important bodies are:

- ETSI (European Telecommunication Standard Institute), developed GSM standards
- ITU-T (International Telecommunication Union Standardization Sector), part of the ITU standardization
- 3GPP (3rd Generation Partnership Project), cooperation between regional standardization body of Europe, North America and Asia; responsible for all standardization of 3G and GSM development





# Trends: Mobile subscriptions

Figure 1: Mobile subscriptions by region, Q3 2012

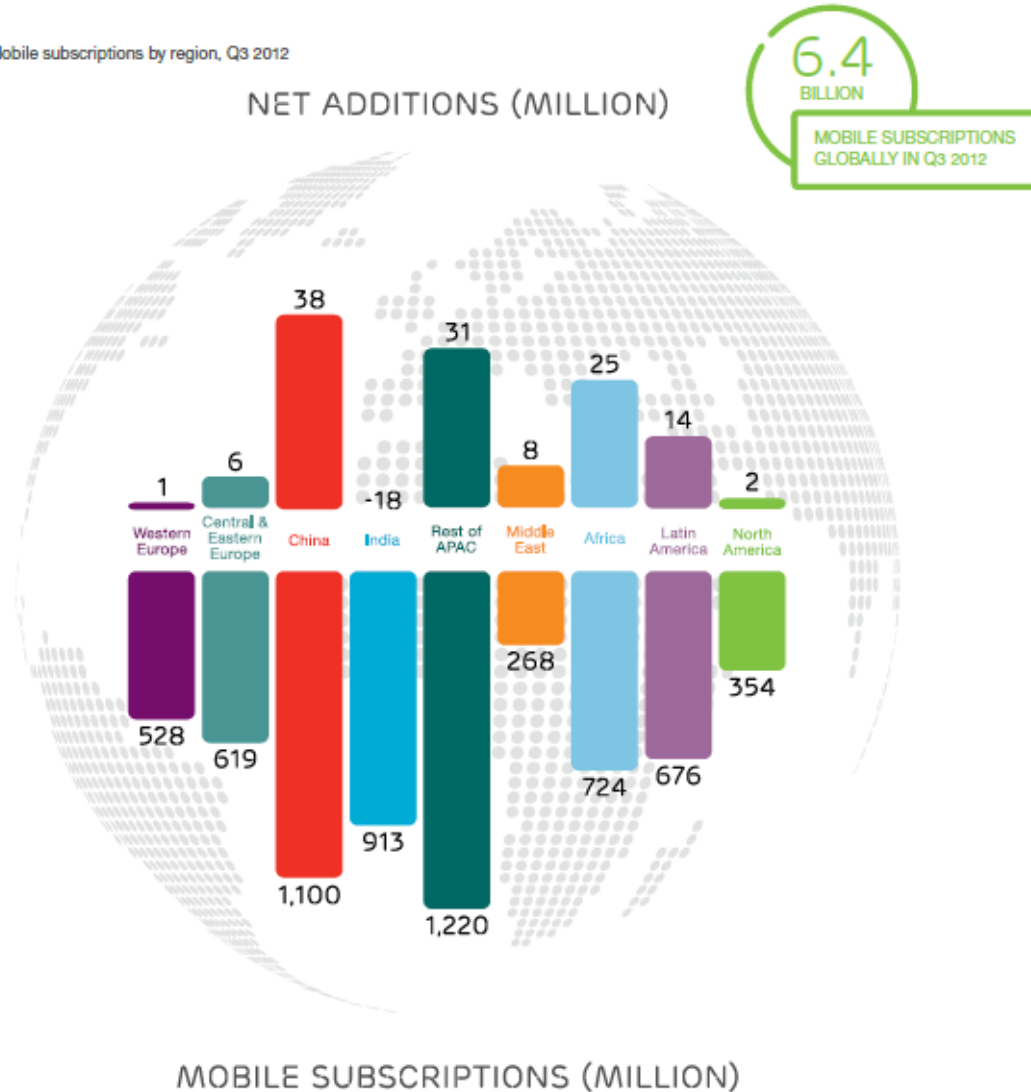

Source: Ericsson (November 2012)

Figure 5: Mobile subscriptions by technology, 2009-2018

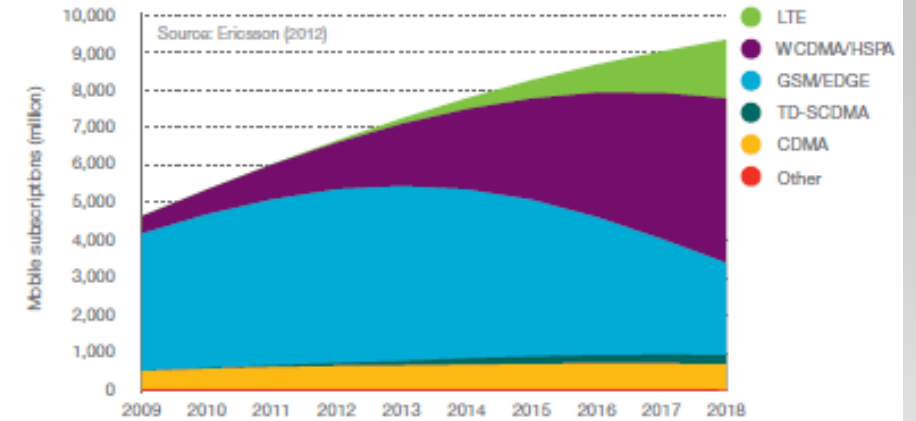

Subscriptions are defined by the most advanced technology that the mobile phone and network are capable of.

Figure 6: Mobile subscriptions by region, 2009-2018

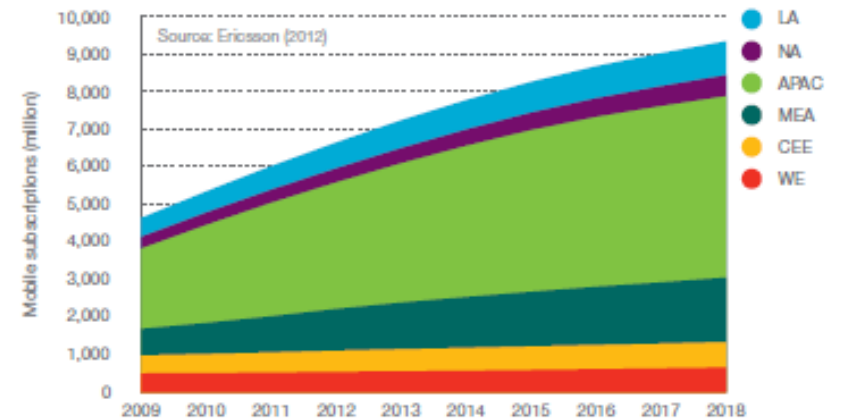

Source: Ericsson mobility report Nov/2012

# Mobile Subscription and technology per region

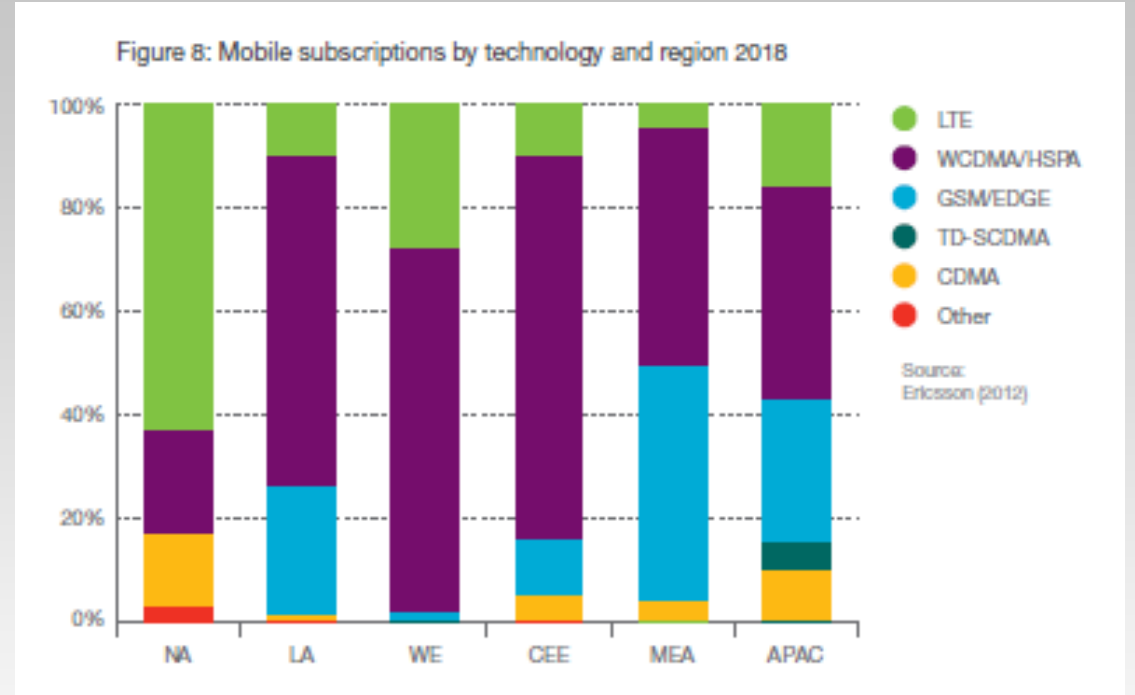
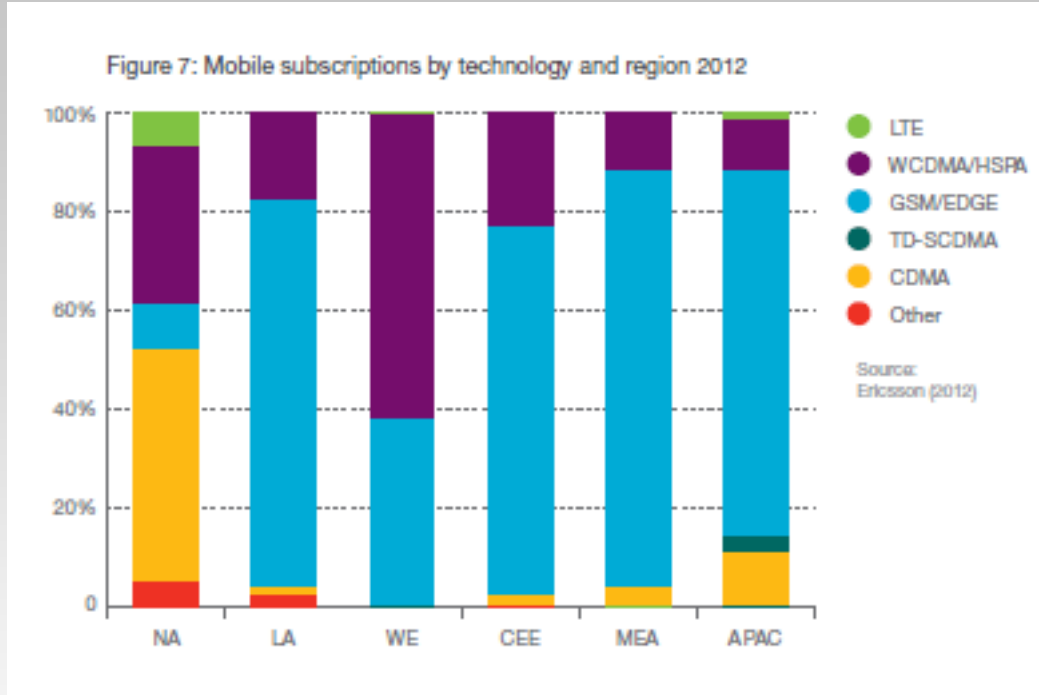

## Take away-

- 3GPP technologies (GSM, WCDMA/HSPA, LTE) are dominant ones
- Going forward, main growth will be in WCDMA/HSPA and LTE technology

# Trend: Traffic development

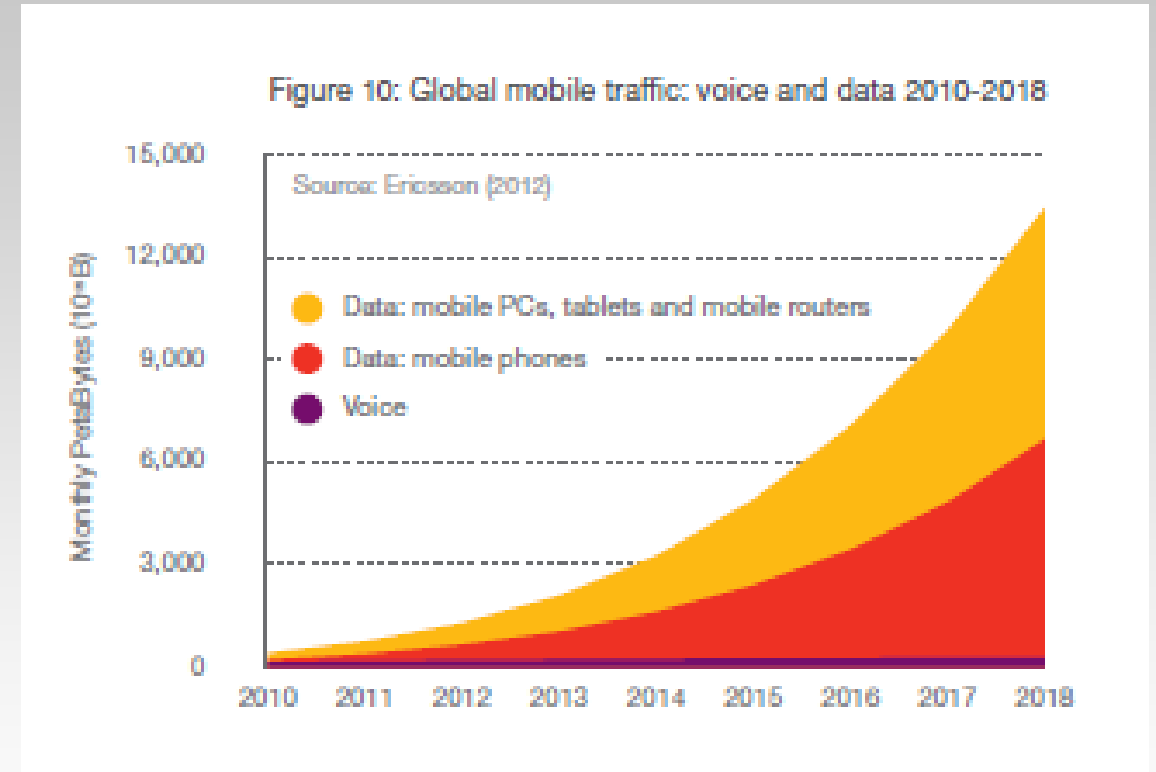
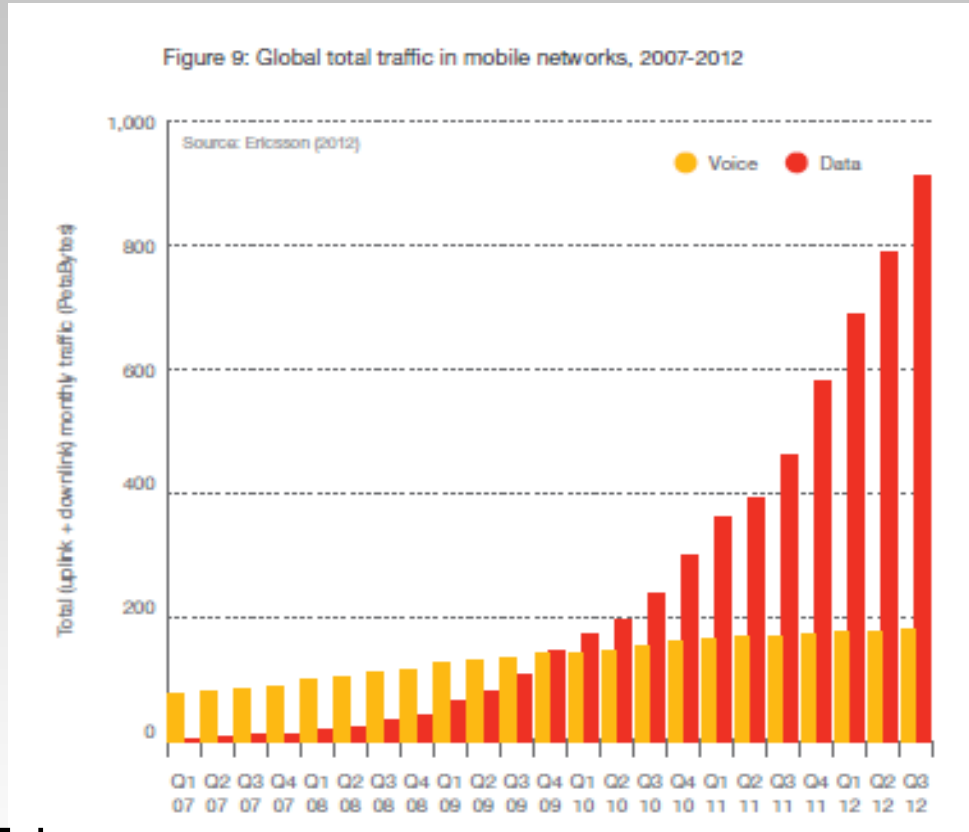

## Take away-

- Mobile data is already the several times of capacity than voice in most Operators network
- And data growth will continue exponentially in the years to come

# Challenges of building future mobile networks

Some of the challenges include

- Provide mobile subscriptions to the low income segment
- Build network capacity to meet the data traffic explosion while revenue growth is minimal
- Limited spectrum
- Invest in new technology (e.g. HSPA+, LTE) while need to keep legacy network (e.g. GSM, CDMA) for many more years
- Main revenue sources of Operators like voice, SMS is increasingly being commoditized by internet players
- Prediction of huge Machine to Machine subscription which will have low ARPU\*.

\*ARPU: Average Revenue per User

# Latest Smartphone

**Bell**

HTC Raider™ 4G LTE

Canada's first  
LTE superphone

Like 3 likes. Sign Up to see what your friends like.

Buy Now



## iPhone 5

- LTE bands 1 (2100), 3 (1800), 4 (AWS), 5 (850), 13 (VzW 700), 17 (AT&T 700), 25 (E1900)
- HSPA bands 850, 900, 1900, 2100
- GSM bands 850, 900, 1800, 1900
- CDMA bands 850, 1900, 2100
- DC-HSDPA



## Samsung Galaxy S II LTE Sveriges första 4G telefon

Samsung Galaxy S II LTE är en ännu snabbare telefon. Den stöder den nya 4G standarden vilket är det snabbaste mobila bredband som finns på marknaden idag. I korthet så är Galaxy S II LTE lite större, något smartare och väldigt mycket snabbare.

Gilla 151

Fler bilder

Se film

**TELE2**

## Nokia Lumia Windows Phone 8



# Agenda

- What is mobile communication?
- History and trends
- Elements in mobile communication systems
- Basic functionality

# Architecture of GSM Network

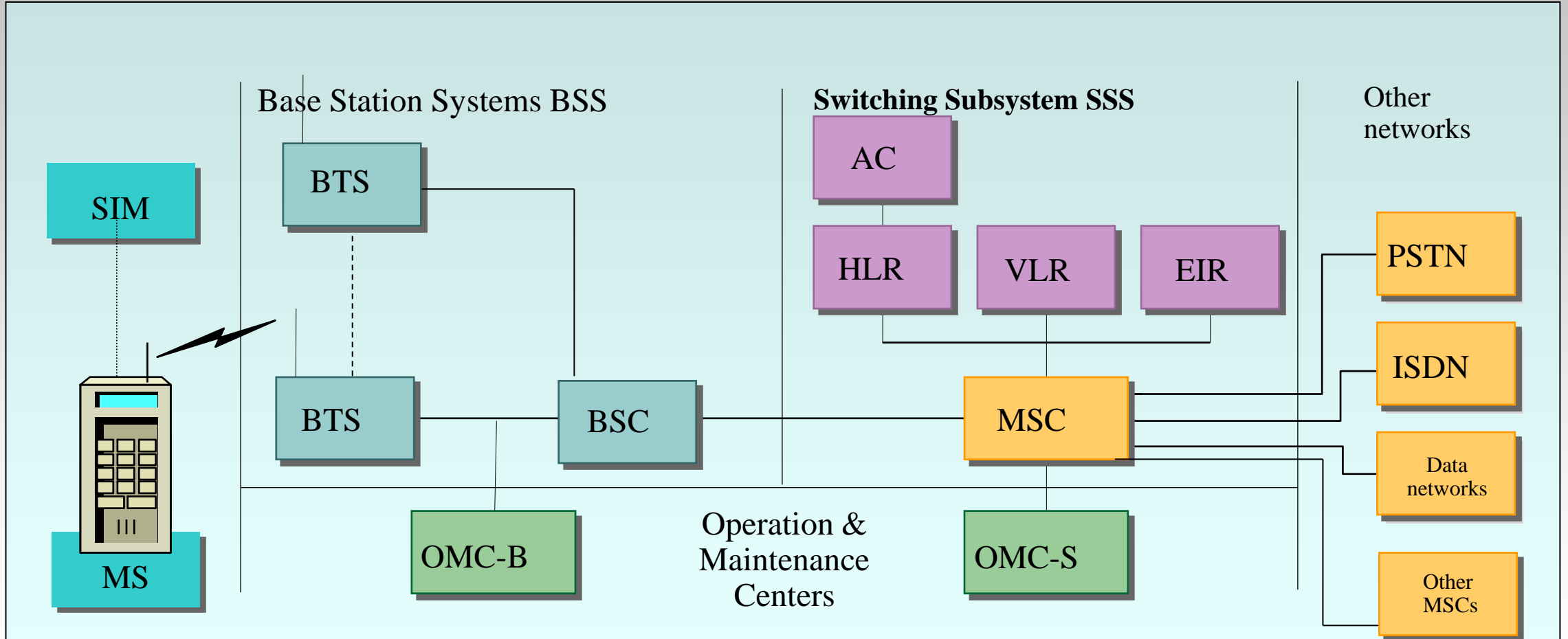

# Basic elements in mobile communication systems

SIM – A smart card stores identification (IMSI) of a subscriber, holds Auth. Key that identifies SIM on the mobile network

ME/MU/MS – the mobile device

BTS – Facilitate wireless communication between UE/ME and the network

BSC – Allocates radio channel to ME, several BTS under the control of one BSC

MSC – carries out call switching (ME-ME, ME-phones of other network)

VLR – linked to MSC, temporary DB of subscriber who roamed into a specific MSC

HLR – a central DB of ME

AuC – to authenticate each SIM

EIR – keeps lists of ME which are to be banned or monitored





# Basic elements

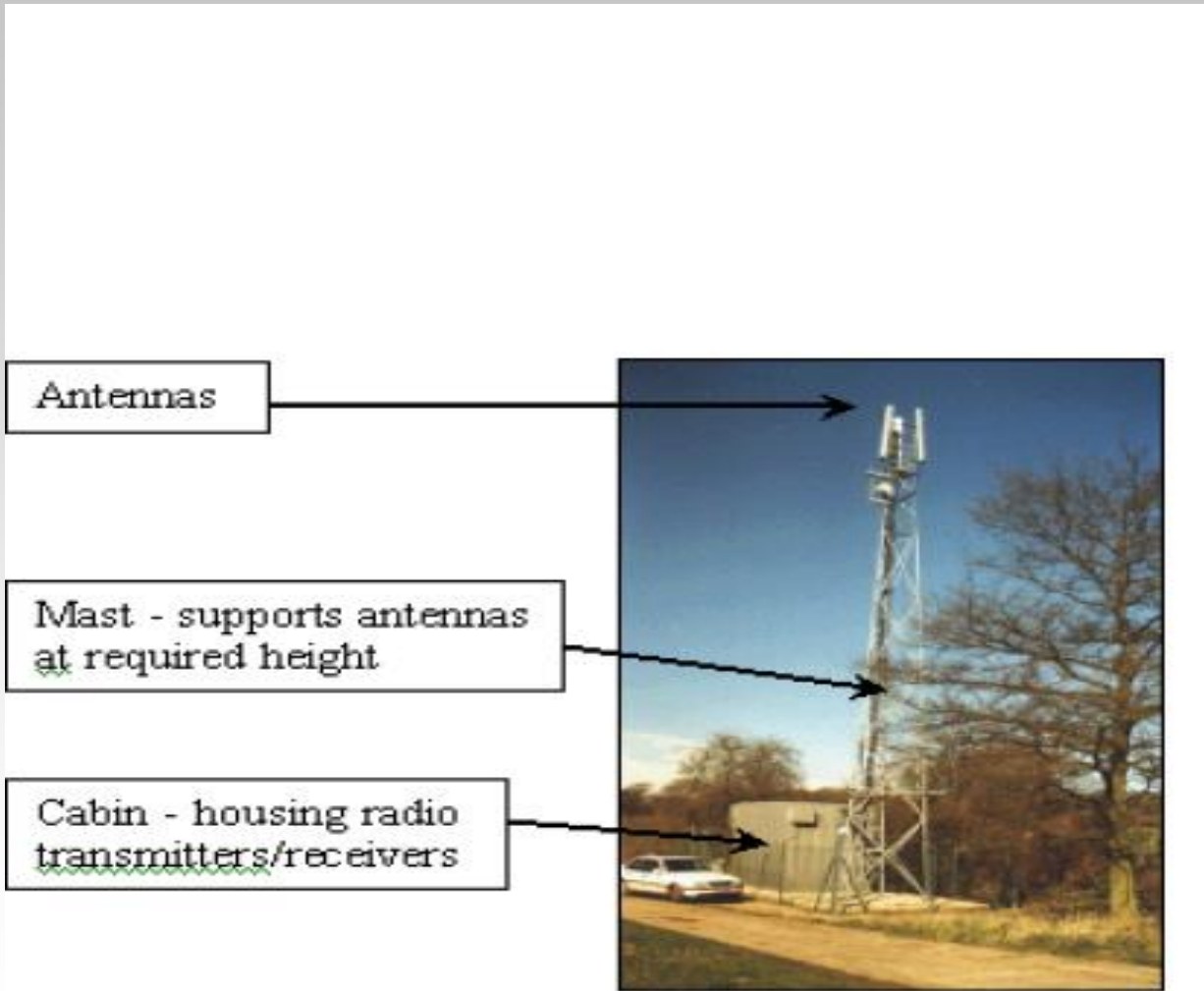

# Some concepts in mobile communications

- **Cell** – A limited geographic area covered by a BTS (e.g. max. Cell size of GSM cell 35km, typically several km)
- **Control channel** – Radio channel used for all control info. e.g. call request, call set up etc.
- **Information channel** – Radio channel used for user info. e.g. data or voice
- **Downlink (forward channel)** – communication from BTS till ME
- **Uplink (reverse channel)** – communication from ME till BTS
- **Handover (handoff)** – transferring an ongoing communication from one BTS to another BTS typically due to movement
- **Full duplex/half duplex/simplex** –
  - Both direction simultaneously/ both direction but only one direction at a time/Only one way communication

# Basic elements

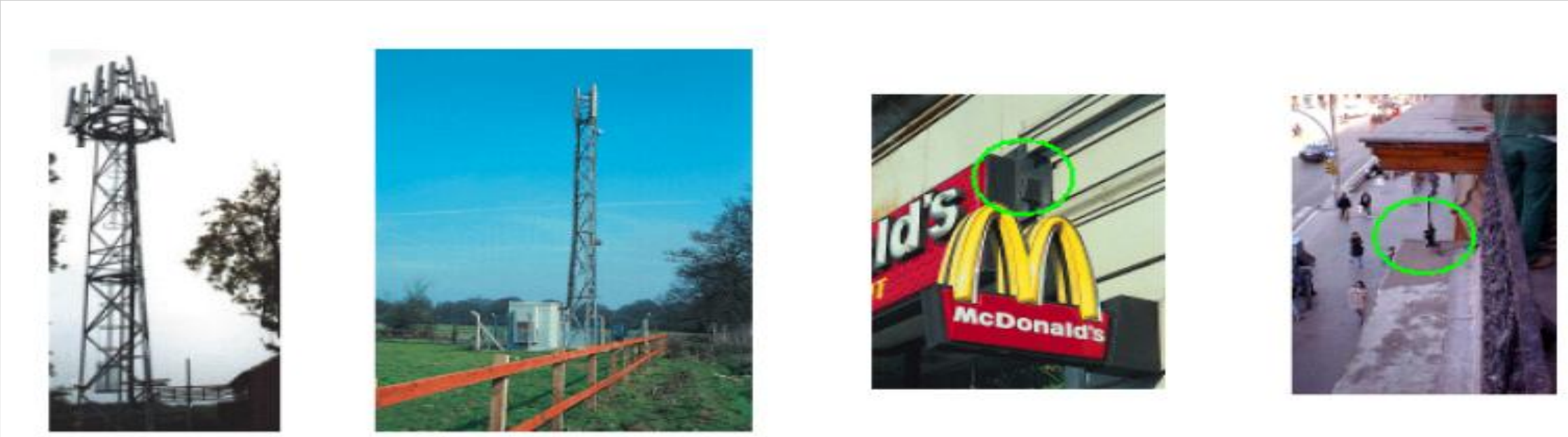

Typical macrocell

Typical microcell

# Agenda

- What is mobile communication?
- History and trends
- Elements in mobile communication systems
- **Basic functionality**

# Services Offered in GSM

## Tele-services

- Mobile telephony
- Emergency calling

## Bearer Services

- Data services up to 9.6 Kbps
- Short Message Service (SMS)
- Fax
- Voice mailbox
- Electronic mail

## Supplementary services

- Call Waiting
- Call Hold
- Call Barring
- Call Forwarding
- Multi Party Call Conferencing
- CLIP
- CLIR
- CUG

# Identification of user and mobile phones

A typical mobile number (MS-ISDN number) follows the numbering plan for telephony (max. 15 digits)

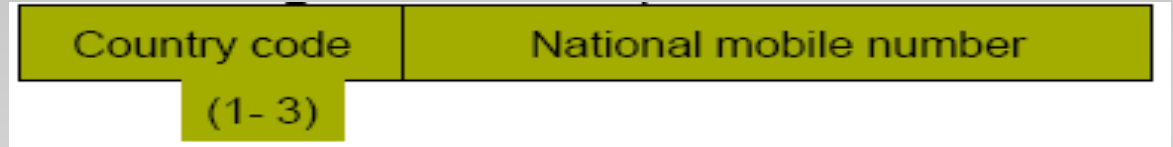

**MSISDN = CC + NDC + SN**

Where, CC = Country Code, NDC= National Destination Code, SN= Subscriber Number

IMSI used to identify (uniquely) mobile subscription internationally (max. 15 digits)

**IMSI = MCC + MNC + MSIN**



**IMEI used to identify ME**

Type `*#06#` to get IMEI

# Circuit switching and packet switching

**Circuit Switching (CS):** In circuit-switched networks, a dedicated path is set up between the two parties. This path remains for the exclusive use of both parties for the duration of the call, and is therefore not available to any other users.

Inefficient mode

E.g. GSM used CS

**Packet switching (PS):** Packet switching involves dividing the data into packets (or cells or frames) prior to transmission. The length of the packets varies enormously, depending on the technology employed. Added to each packet is the destination address, together with other control information. The packets are then transmitted across the network. This addressing means there is no requirement to set up a pre-established link. To some extent, each individual packet can be viewed as being able to find its own way to its destination.

In a packet-switched network, the resources are shared between many users.

Efficient but of course takes more data field

E.g. from 2.5 G uses PS

# Message services

## SMS

A text communication service of mobile communication system using standard communication protocols that allow short text messages (typically 160 characters) between mobile devices or between fixed lines and mobile devices.

SMS service is the most successful mobile service commercially

## MMS

MMS is a standard way to send multimedia content (e.g. text, audio, video) to and from Phone

Both SMS and MMS are 'store and forward' service



# Security functionality

The purpose of security features is to protect users and the network against abuse:

- Verification that the user has a valid subscription
- Verification of the network that the user communicates with a 'real' network entity
- Protection of user's identity against tracking
- Protection against eavesdropping by radio link

Mutual authentication crucial (e.g. In 3G, not in 2G)

User's identity information is stored both in SIM card and in the network

Advanced encryption method is used on radio channel to protect information

Security mechanisms are also used in core network (not only in access network where information is transmitted over the radio)

BUT there is no appropriate location privacy in today's mobile network

# Roaming

The continuity of communication services in a location that is different from the home location where the service was registered.

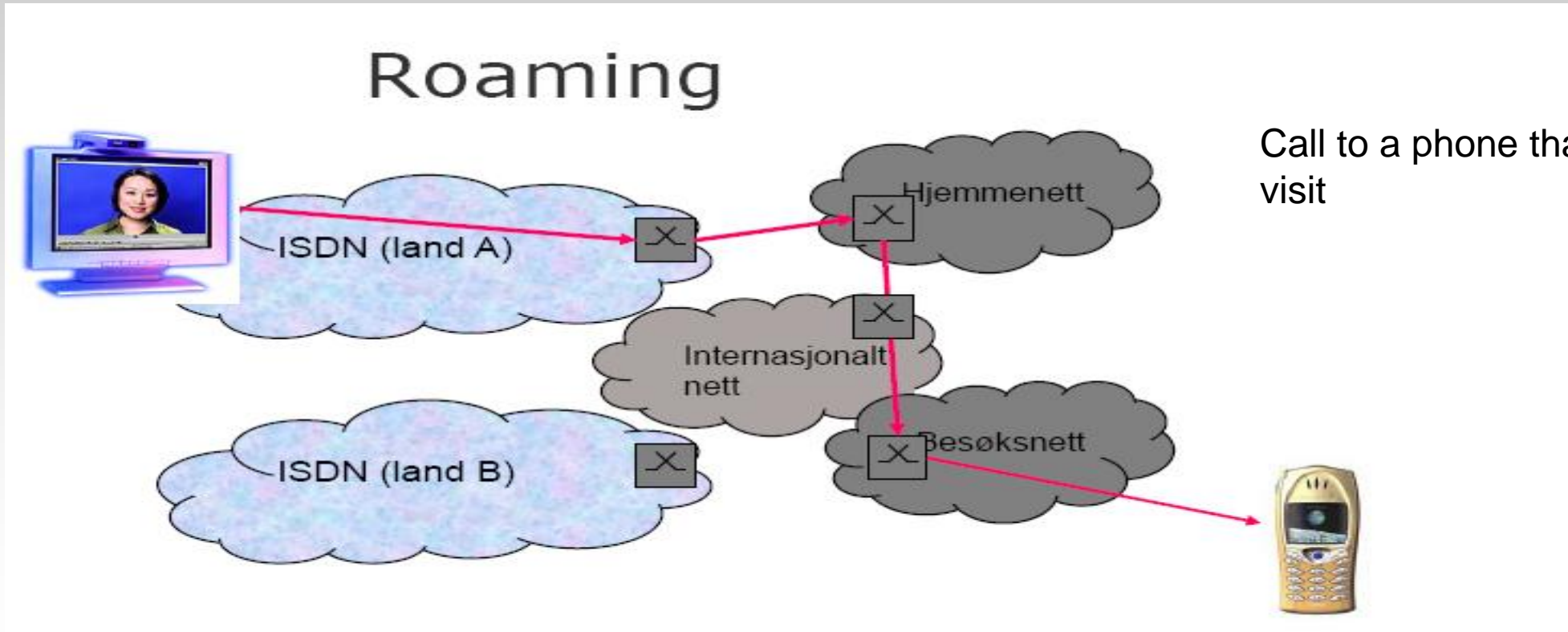

# Roaming

Mobile to mobile call in a visited network

## Roaming (2)

